



US006826488B1

(12) **United States Patent**
Collart et al.

(10) **Patent No.:** US 6,826,488 B1

(45) **Date of Patent:** Nov. 30, 2004

(54) **CRYSTALS, MOLECULAR COMPLEXES,
AND METHODS OF DEVELOPING LEAD
COMPOUNDS FOR INHIBITORS OF
BACTERIAL IMPDH**

(75) Inventors: **Frank R. Collart**, Bolingbrook, IL
(US); **Eliezer Huberman**, LaGrange, IL
(US); **Andrzej Joachimiak**,
Bolingbrook, IL (US); **Rongguang
Zhang**, Westmont, IL (US); **Edwin M.
Westbrook**, Lemont, IL (US)

(73) Assignee: **The University of Chicago**, Chicago,
IL (US)

(*) Notice: Subject to any disclaimer, the term of this
patent is extended or adjusted under 35
U.S.C. 154(b) by 0 days.

(21) Appl. No.: **09/533,466**

(22) Filed: **Mar. 23, 2000**

(51) **Int. Cl.**⁷ **G06F 19/00**; G01N 33/48;
G01N 33/53

(52) **U.S. Cl.** **702/27**; 702/19; 435/7.1

(58) **Field of Search** 702/19, 27; 435/7.1,
435/190; 434/277, 278; 530/350; 514/1

(56) **References Cited**

U.S. PATENT DOCUMENTS

6,128,582 A * 10/2000 Wilson et al. 702/27

OTHER PUBLICATIONS

Drenth, J., *Principles of Protein X-ray Crystallography*
[Published by Springer-Verlag New York Inc., 175 Fifth
Ave., New York, NY 10010], pp. 1-19, 1994.*

Fleming et al., *Biochemistry*, vol. 35, pp. 6990-6997, 1996.*
Geysen et al, *Cognitive features of continuous antigenic
determinants. J. of Molecular Recognition*, vol. 1, pp.
32-40, 1988.*

Russell et al. Structural features can be unconserved in
proteins with similar folds. (*Journal of Molecular Biology*,
vol. 244, pp. 332-350, 1994.*

Zhang et al. Characteristics and crystal structure of bacterial
inosine-5'-monophosphate dehydrogenase. *Biochemistry*,
vol. 38, pp. 4691-4700, Apr. 13, 1999.*

Allison A. and Eugui E.(1996) "Purine metabolism and
immunosuppressive effects of mycophenolate mofetil
(MMF)," *Clin Transplantation* 10: 77-84.

Antonino L. et al. (1994) "Probing the active site of human
IMP dehydrogenase using halogenated purine riboside
5'-monophosphates and covalent modification reagents,"
Biochemistry 33: 1760-1765.

Antonino L. and Wu J. (1994) "Human IMP Dehydrogenase
catalyzes the dehalogenation of 2 fluoro- and 2-chloro-
inosine 5'-monophosphate in the absence of NAD," *Bio-
chemistry* 33:1753-1759.

Ashbaugh C. and Wessels M.(1995) "Cloning, sequence
analysis and expression of the group A streptococcal guaB
gene encoding inosine monophosphate dehydrogenase,"
Gene 165: 57-60.

(List continued on next page.)

Primary Examiner—Ardin H. Marschel

(74) *Attorney, Agent, or Firm*—Alice O. Martin; Barnes &
Thornburg LLP

(57) **ABSTRACT**

The present invention relates to a data storage medium
encoded with the structural coordinates of crystallized mole-
cules and molecular complexes which comprise the active
site binding pockets of bacterial IMPDH. Such data storage
material is capable of displaying such molecules and
molecular complexes, or their structural homologues, as a
graphical three-dimensional representation on a computer
screen. This invention also relates to methods of using the
structure coordinates to solve the structure of homologous
proteins or protein complexes. In addition, this invention
relates to methods of using the structure coordinates to
screen and design compounds, including inhibitory
compounds, that bind to IMPDH or homologues thereof.
This invention also relates to molecules and molecular
complexes that comprise the active site binding pockets of
IMPDH or close structural homologues of the active site
binding pockets. This invention also relates to compounds
and pharmaceutical compositions which are inhibitors of
bacterial IMPDH.

5 Claims, 8 Drawing Sheets

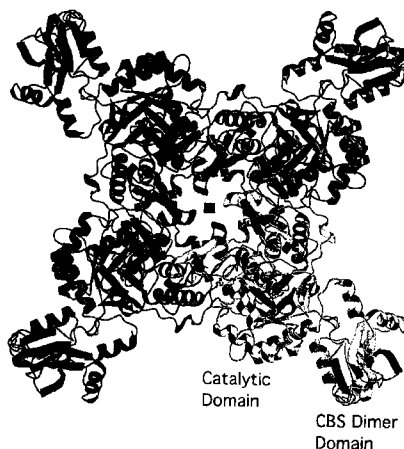

OTHER PUBLICATIONS

- Bateman A. (1997) "The structure of a domain common to archaeobacteria and the homocystinuria disease protein," *TIBS* 22, 12–13.
- Brunger A. et al. (1998) "Crystallography & NMR system: a new software suite for macromolecular structure determination," *Acta Crystal* 54: 905–921.
- Collart F. and Huberman E. (1990) "Expression of IMP dehydrogenase in differentiating HL-60 cells," *Blood* 75:570–576.
- Collart F. et al. (1996) "Cloning, characterization and sequence comparison of the gene coding for IMP dehydrogenase from *pyrococcus furiosus*," *Gene* 174:209–216.
- Collart F. et al. (1996) "Cloning and characterization of the gene encoding IMP dehydrogenase from *Arabidopsis thaliana*," *Gene* 174:217–220.
- Hager P. et al. (1994) "Recombinant human inosine monophosphate dehydrogenase type I and type II proteins," *Biochemical Pharmacology* 49:1323–1329.
- Halloran PF. (1996) "Molecular mechanisms of new immunosuppressants," *Clin Transplantation* 10:118–123.
- Hendrickson W. (1991) "Determination of macromolecular structures from anomalous diffraction of synchrotron radiation," *Science* 254:51–58.
- Huete-Perez J. (1995) "Identification of the IMP binding site in the IMP dehydrogenase from *Trichomonas foetus*," *Biochemistry* 34:13889–13894.
- Jayaram H. (1992) "Clinical pharmacokinetic study of tiazofurin administered as a 1-hr infusion," *Int J. Cancer* 51:182–188.
- Kabsch W and Sander C. (1983) "Dictionary of protein secondary structure: pattern recognition of hydrogenbonded and geometrical features," *Biopolymers* 22:2577–2637.
- Kerr K. and Hedstron L. (1997) "The roles of conserved carboxylate residues in IMP dehydrogenase and identification of a transition state analog," *Biochemistry* 36:13365–13373.
- Kiguchi et al. (1990) "Induction of cell differentiation in melanoma cells by inhibitors of IMP dehydrogenase: altered patterns of IMP dehydrogenase expression and activity," *Cell Growth and Differentiation* 1:259–270.
- Link J. and Straub K. (1996) "Trapping of an IMP dehydrogenase-substrate covalent intermediate by mycophenolic acid," *J. Am. Chem. Soc.* 118: 2091–2092.
- Navaza J. and Saludjian P. (1997) "AMoRe: an automated molecular replacement program package," *Methods in Enzymology* 275:581–594.
- Nimmegern et al. (1996) "Conformational changes and stabilization of inosine 5'-monophosphate dehydrogenase associated with ligand binding and inhibition by mycophenolic acid," *Journal of Biological Chemistry* 271: 19421–19427.
- Otwinowski Z. and Minor W. (1997) "Processing of x-ray diffraction data collected in oscillation mode," *Methods in Enzymology* 276:307–325.
- Pannu et al. (1998) "Incorporation of prior phase information strengthens maximum-likelihood structure refinement," *Acta Crystl* 54: 1285–1294.
- Ramakrishnan V. and Biou V. (1997) "Treatment of multi-wavelength anomalous diffraction data as a special case of multiple isomorphous replacement," *Methods in Enzymology* 276: 538–557.
- Rice L. and Brunger A. (1994) "Torsion angle dynamics: reduced variable conformational sampling enhances crystallographic structure refinement," *PROTEINS: Structure, Function, and Genetics* 19: 277–290.
- Sintchak et al. (1996) "Structure and mechanism of inosine monophosphate dehydrogenase in complex with the immunosuppressant mycophenolic acid," *Cell* 85: 921–390.
- Smith et al. (1991) "A controlled trial of aerosolized ribavirin in infants receiving mechanical ventilation for severe respiratory syncytial virus infection," *The New England Journal of Medicine* 325: 24–29.
- Wang et al. (1996) "Inactivation of inosine 5'-monophosphate dehydrogenase by the antiviral agent 5-ethynyl-1-beta-D-Ribofuranosylimidazole-4-Carboxamide 5'-monophosphate," *Biochemistry* 35:95–101.
- Westbrook E. and Naday I. (1997) "Charge-coupled device-based area detectors," *Methods in Enzymology* 276: 244–268.
- Whitby F. (1997) "Crystal structure of *trichomonas foetus* inosine-5' monophosphate dehydrogenase and the enzyme-product complex," *Biochemistry* 36:10666–10674.
- Xiang B. and Markham G. (1997) "Probing the mechanism of inosine monophosphate dehydrogenase with kinetic isotope effects and NMR determination of hydride transfer stereospecificity," *Archives of Biochemistry and Biophysics* 348: 378–382.
- Zhou et al. (1997) "Expression, purification, and characterization of inosine 5'-monophosphate dehydrogenase from *borrelia burgdorferi*," *Journal of Biological Chemistry* 272:21977–21981.
- Zhang, R., et al. (1999) "Characteristics and Crystal Structure of Bacterial Inosine-5'-Monophosphate Dehydrogenase." *Biochemistry* 38: 4691–4700.

* cited by examiner

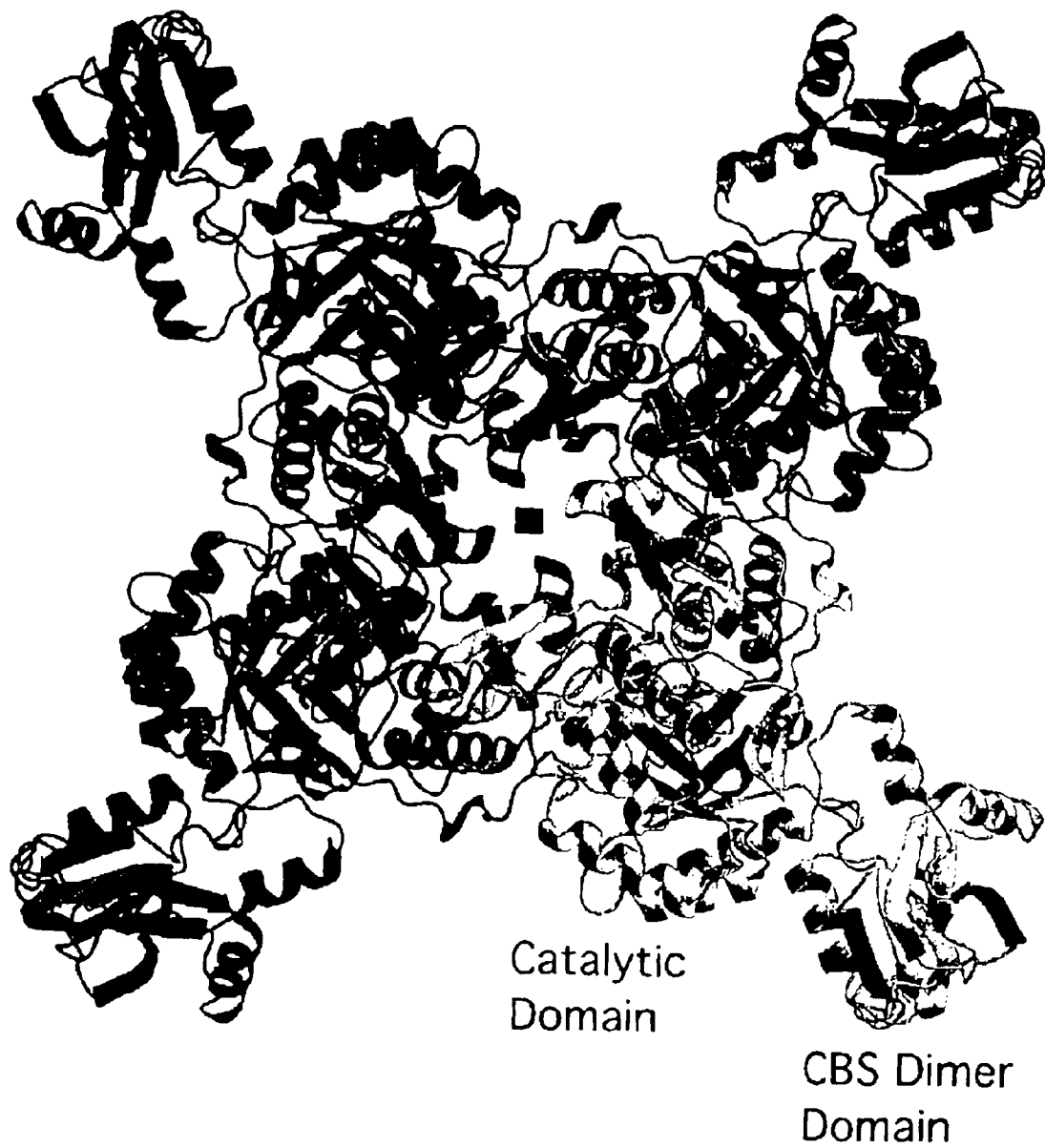

FIG. 1a

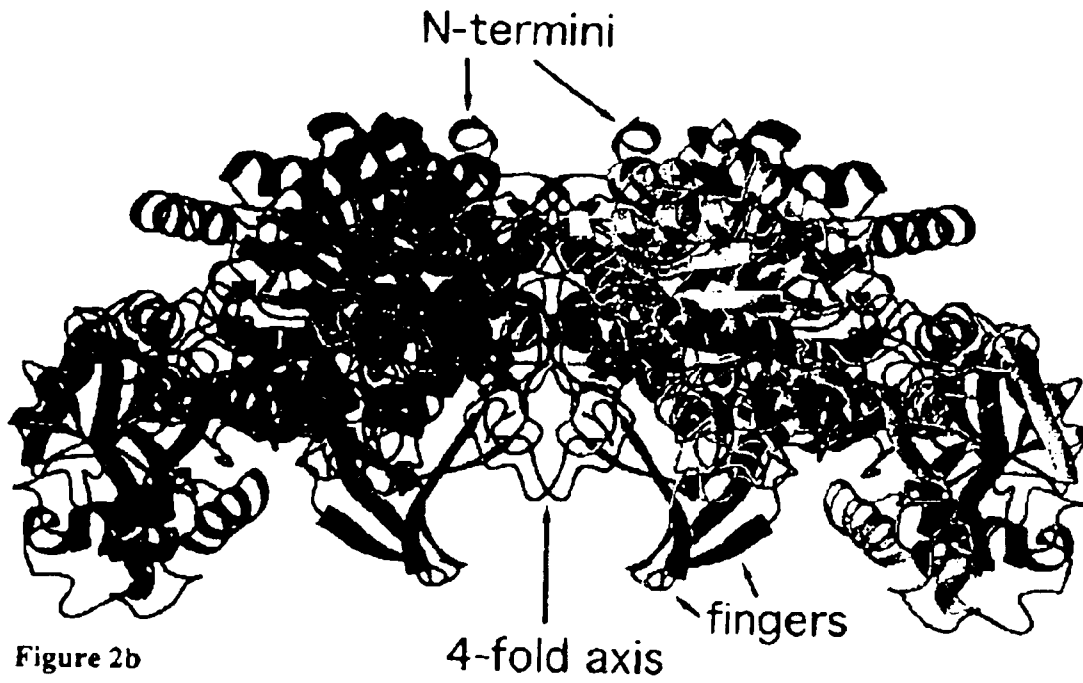

Figure 2b

FIG. 1b

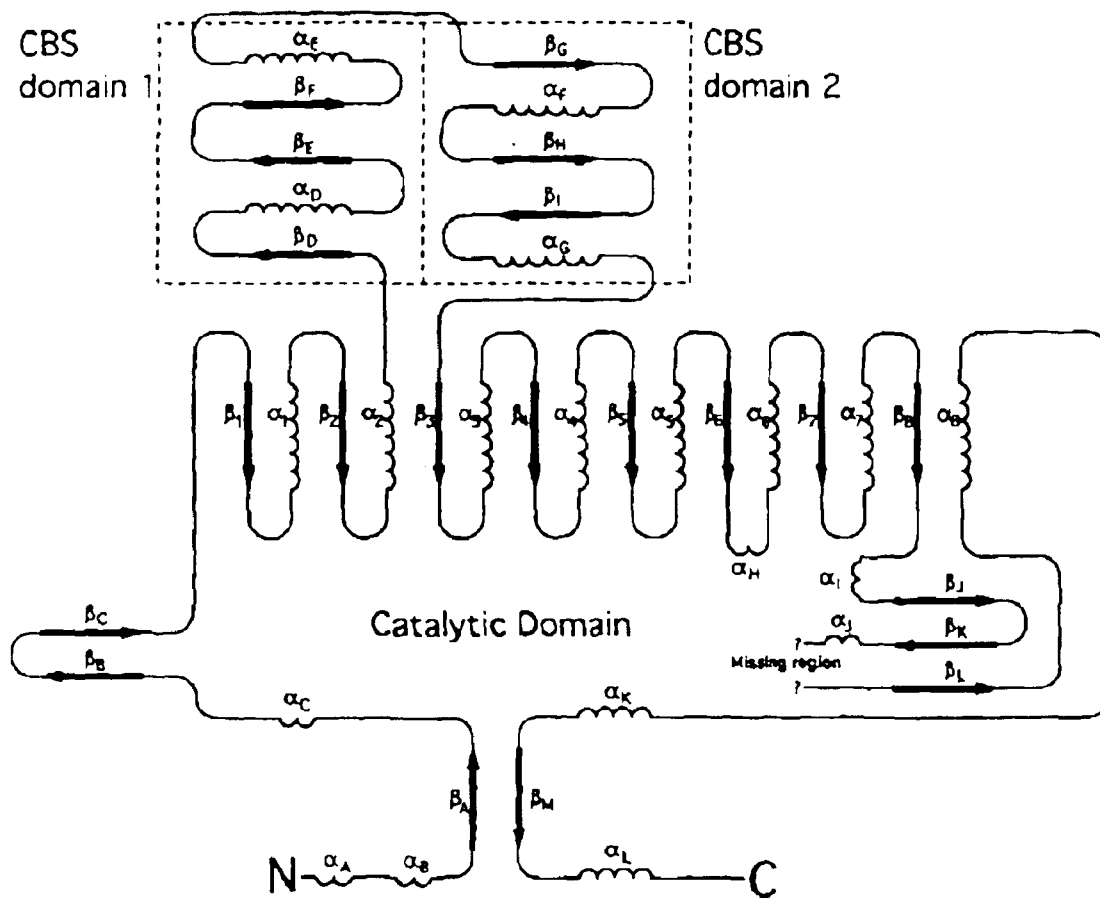

FIG. 2a

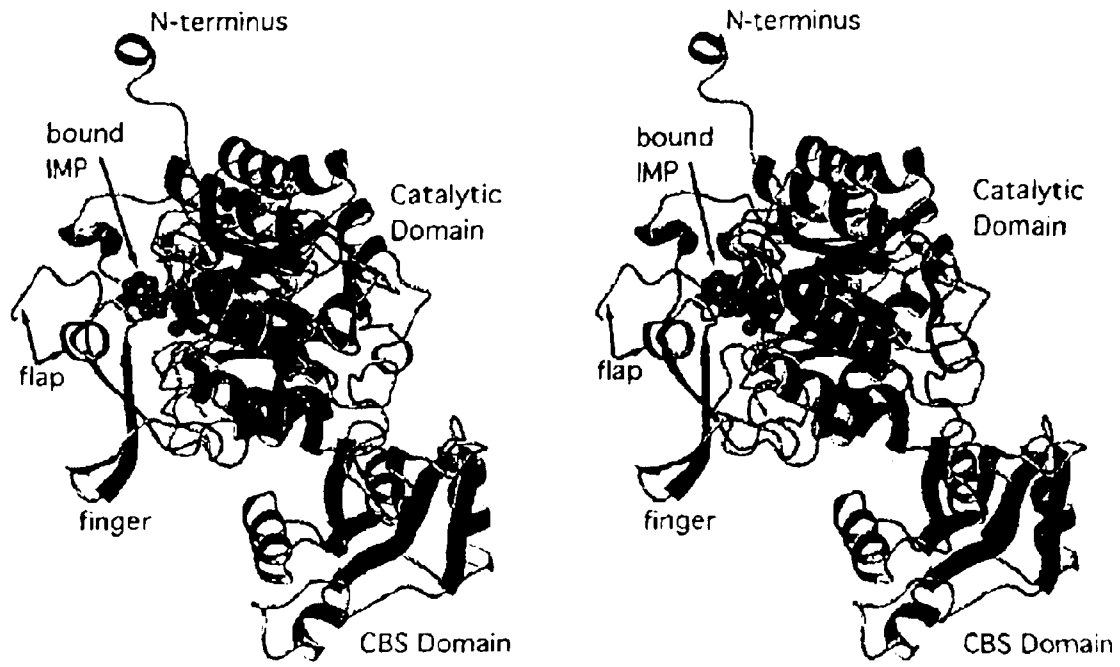

FIG. 2b

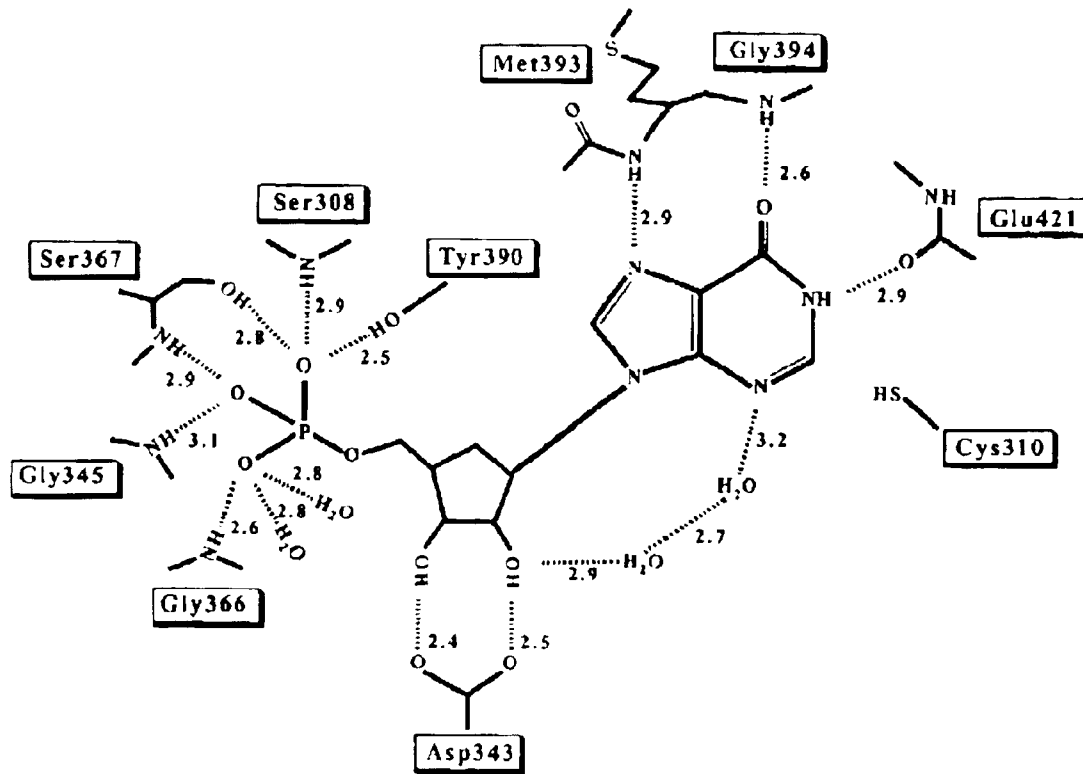

FIG. 3a

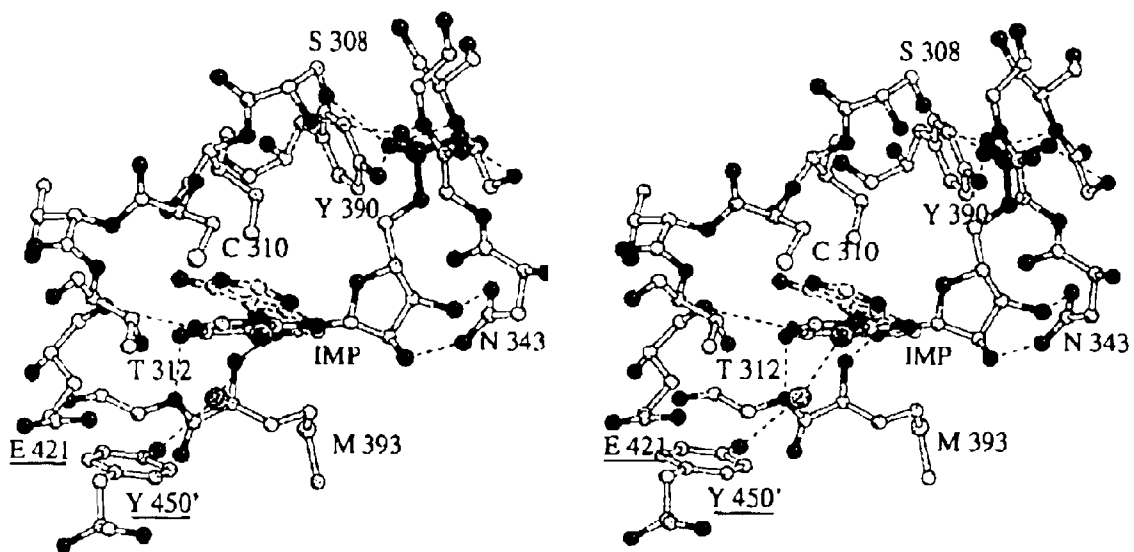

FIG. 3b

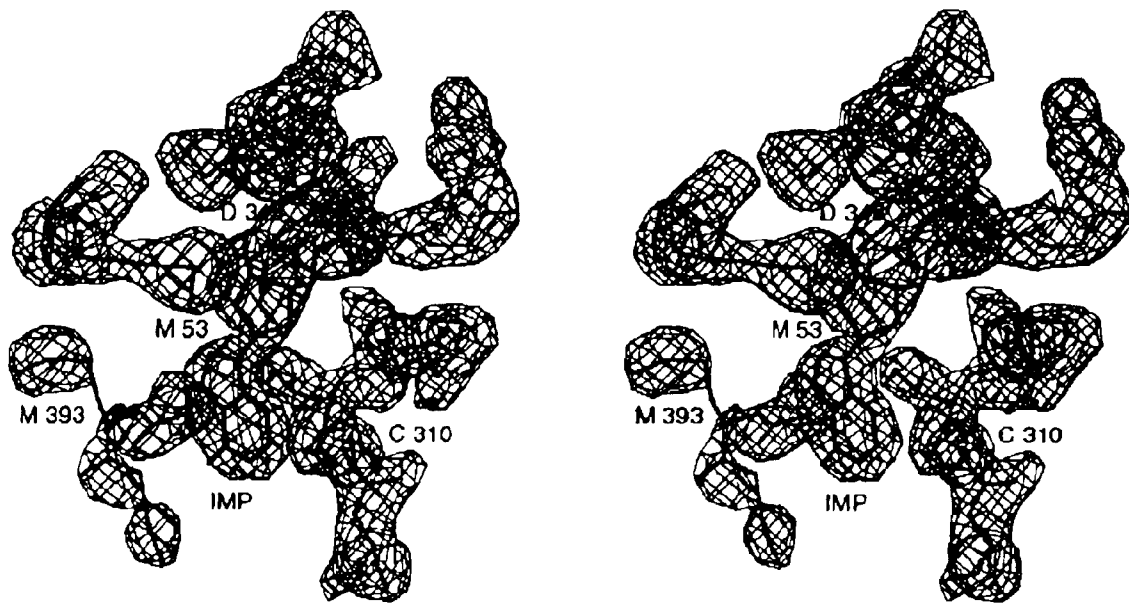

FIG. 4

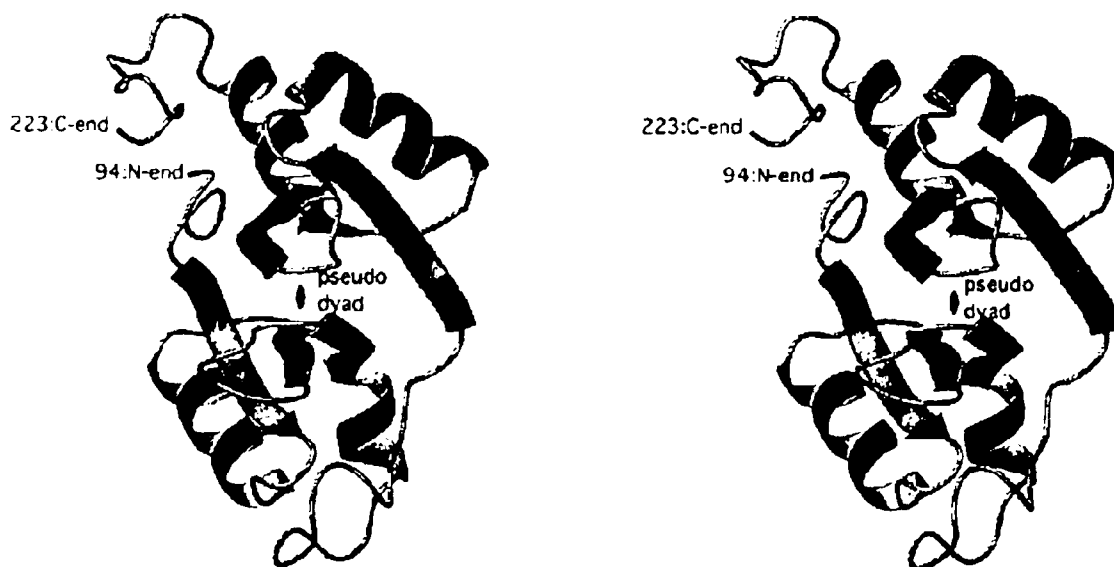

FIG. 5

**CRYSTALS, MOLECULAR COMPLEXES,
AND METHODS OF DEVELOPING LEAD
COMPOUNDS FOR INHIBITORS OF
BACTERIAL IMPDH**

The United States Government has rights in this invention pursuant to contract Number W-31-109-ENG-38 between the United States Government and Argonne National Laboratory.

BACKGROUND OF THE INVENTION

The invention relates the crystal structure of IMPDH isolated from bacteria. The structure is different from the structure of mammalian or fungal IMPDH, allowing design of selective inhibitors of bacterial IMPDH.

Inosine monophosphate dehydrogenase (IMPDH; Enzyme Commission (EC) 1.1.1.205) is a rate-limiting enzyme in the synthesis of guanine ribonucleotides. IMPDH has an essential role in providing critical precursors for DNA and RNA biosynthesis and in signal transduction pathways that mediate cell differentiation (Collart et al., 1990; Kiguchi et al., 1990). Because of its central role in purine metabolism, IMPDH is an attractive therapeutic target. Several recent reviews have outlined the utility of mammalian IMPDH inhibitors as anticancer (Pankiewicz, 1997) or antiviral (Andrei et al, 1993) agents or as immunosuppressive drugs (Halloran, 1996) (see Table 1).

TABLE 1

Clinically Useful Inhibitors of IMPDH	
Inhibitor	Clinical Application
Ribavirin	Antiviral
Mycophenolate mofetil	Immunosuppression
Mizoribine	Imunosuppression
Tiazofurin	Anticancer

Although there are no reports of selective inhibitors of bacterial IMPDH enzymes, such compounds could have potential application as specific antimicrobial agents.

The active form of IMPDH enzymes (50–55 kDa) is a homotetramer with four active sites per tetramer. A cysteine residue in the active site forms a covalent intermediate with IMP (Wang et al., 1996). A consensus sequence of thirteen amino acid residues that includes cysteine in this active site has been proposed as a signature motif (i.e., an amino acid sequence that can be used as a fingerprint or specific identifier for this class of enzymes) for the IMPDH and guanosine monophosphate (GMP) reductase enzymes (Bairoch, 1995). This IMPDH consensus region is highly conserved in both bacteria and eukaryotes, with 90% and 85% of the respective residues being identical within each kingdom. However, only 40% of these residues remain identical when compared between the two kingdoms. This limited conservation suggests that bacterial and eukaryotic IMPDH enzymes may have distinct characteristics; a suggestion supported by their kinetic differences and differential sensitivity to inhibitors. Enzymes from mammalian sources show distinctly lower values for the K_m for nicotinamide adenine dinucleotide (NAD) than do those enzymes from bacteria. In addition, mammalian IMPDH enzymes are 10–100 times more sensitive to inhibition by mycophenolic acid (MPA) than are bacterial IMPDH enzymes. Sequence analysis of all known IMPDH enzymes supports the distinction between bacterial and eukaryotic enzymes. A deep branching of the bacterial and eukaryotic forms of IMPDH

is observed upon phylogenetic analysis of the relationships among the various IMPDH genes (Collart et al, 1996 a and b). This phylogenetic analysis indicates a general functional conservation of amino acid and suggests a unique amino acid sequence signature for these kingdoms.

The elucidation of a kingdom-specific signature for IMPDH enzymes is an important element in the development of specific inhibitors. The two partial structures of IMPDH from Chinese hamster (Sintchak et al., 1996) (85% structure complete with bound transition state analogue and mycophenolic acid, MPA) and *Tritrichomonas foetus* (Whitby et al., 1997) (68% structure complete with bound xanthosine monophosphate [XMP]) have been reported with only the coordinates of the latter available in the Protein Data Bank (PDB). These structures furnished the initial information about the structure and reaction mechanism of eukaryotic IMPDH enzymes. Inhibitors of IMPDH in bacteria are needed to treat infections, in particular, to overcome the barrier of antibiotic resistance.

BRIEF SUMMARY OF THE INVENTION

The invention relates for the first time a crystal structure of a bacterial IMPDH. This invention relates that bacterial and mammalian IMPDH enzymes provide the same catalytic function, but have a set of unique structural and biochemical characteristics. An embodiment is a crystal structure of IMPDH isolated from *Streptococcus pyogenes*. *S. pyogenes* IMP dehydrogenase represents the class of bacterial IMPDH enzymes that show distinct functional differences when compared to mammalian IMPDH enzymes. The bacterial enzymes bind NAD poorly (Zhou et al., 1997; Kerr et al., 1997) ($K_M > 1$ mM) and are inhibited by MPA only at very high concentrations ($K_i > 0.5$ mM). Elucidation of the structural basis of these distinct characteristics is useful to aid in design of specific IMPDH inhibitors that will inhibit the infectious agent without harming the host's IMPDH.

The coding sequence of bacterial IMPDH specifies a protein of 493 amino acids that contain only a single cysteine residue at the active site (Ashbaugh et al., 1995). IMPDH from *S. pyogenes* is a representative bacterial enzyme because the organism is pathogenic, and therefore a good model for the investigation of enzyme inhibitors. Streptococci are the most common cause of worldwide pneumonia and a leading cause of pediatric infections. The structure of the *S. pyogenes* bacterial IMPDH provides the basis for elucidation of the structural characteristics that distinguish bacterial from eukaryotic IMPDH enzymes. Knowledge of these characteristics permits an understanding of why these enzymes exhibit functionally distinct behavior and therefore provides a foundation for the design of specific inhibitors of IMPDH that have clinical value.

In addition to inhibiting pathogens, the immunosuppressive use of IMPDH inhibitors is applicable to treat chronic inflammatory diseases such as arthritis, diabetes, or systemic lupus erythromotosis. Use of the IMPDH structure from *S. pyogenes* will facilitate identification of other pathogens that will be inhibited by drugs that inhibit *S. pyogenes*.

Definitions and Abbreviations

A “binding pocket” is a space in a molecule in which an inhibitor of the molecule is bound.

The following abbreviations are used throughout the application:

A = Ala = Alanine
V = Val = Valine
L = Leu = Leucine
I = Ile = Isoleucine
P = Pro = Proline
F = Phe = Phenylalanine
W = Trp = Tryptophan
M = Met = Methionine
G = Gly = Glycine
S = Ser = Serine
T = Thr = Threonine
C = Cys = Cysteine
Y = Tyr = Tyrosine
N = Asn = Asparagine
Q = Gln = Glutamine
D = Asp = Aspartic Acid
E = Glu = Glutamic Acid
K = Lys = Lysine
R = Arg = Arginine
H = His = Histidine
CBS = Cystathionine- β -synthase
GMP = Guanosine monophosphate
IMP = Inosine monophosphate
IMPDH = Inosine monophosphate dehydrogenase
MPA = Mycophenolic acid
NAD = Nicotinamide adenine dinucleotide
PDB = Protein Data Bank
XMP = Xanthosine monophosphate

BRIEF DESCRIPTION OF THE DRAWINGS

FIG. 1 is a ribbon drawing of the catalytically active IMPDH tetramer; the tetramer is displayed parallel (FIG. 1a) and perpendicular (FIG. 1b) to the four-fold axis. Each subunit is shown with a spacefilling model of IMP, the active site of each subunit.

FIG. 2 is a representation of the secondary structure of the IMPDH monomer. (FIG. 2a) Topology diagram of IMPDH domains. Secondary structure was assigned using the Kabach and Sander (1983) algorithm along with visual inspection. The α helices and β strands that form the TIM barrel fold are labeled α_1 - α_8 and β_1 - β_8 . The remaining strands and helices are designated in alphanumeric order (e.g., α_A - α_L). The part of the structure not visible in the electron density maps is marked as "?". (FIG. 2b) Stereoview ribbon diagram arranged approximately perpendicular to the axis of the TIM barrel fold; IMP is shown as a ball and stick model.

FIG. 3 shows an IMPDH active site. (FIG. 3a) is a cartoon of bound IMP showing side chain interactions and active site residues. (FIG. 3b) is a stereoview ball and stick diagram of bound IMP illustrating the alignment of the hypoxanthine ring relative to the catalytic Cys310 residue. The dashed ring cartoon indicates the proposed realignment of the hypoxanthine ring initiated by NAD binding. Residues targeted for mutagenesis (E421 and Y450) are underlined. The "" symbol on Y450 indicates a symmetry related molecule.

FIG. 4 is a stereoview of the electron density map around the active site; the solvent-flattened MAD map is calculated at 2.5 Å resolution drawn at a contour level of 1.2 σ .

FIG. 5 is a representation of the secondary structure of the CBS dimer domain shown as a stereoview ribbon diagram arranged approximately along the dyad axis of the two CBS motifs.

DETAILED DESCRIPTION OF THE INVENTION

The invention relates the crystal structure of a bacterial IMPDH with substrate bound in the catalytic site. Condi-

tions for producing a crystal from bacterial IMPDH were completely different than for humans. The structure was determined using SeMet-substituted protein and multi-wavelength anomalous diffraction (MAD) (Hendrickson, 1991) analysis of data obtained with synchrotron radiation from the undulator beamline of the Structural Biology Center at the Advanced Photon Source. The high quality of the data allowed determination of the structure of both catalytic and cystathionine- β -synthase (CBS) dimer domains. The α/β barrel domain of IMPDH embodies the catalytic framework. The CBS dimer domain contains two CBS motifs that are known to play a regulatory role in other proteins. However, their function in IMPDH is unknown. This is the first crystal structure reported of a complete CBS dimer domain. Bacterial and mammalian IMPDH enzymes have distinct kinetic and biochemical characteristics. Comparison of this bacterial IMPDH with the known partial structures from eukaryotic organisms provides an explanation of their distinct properties and contributes to the design of specific bacterial inhibitors.

Structure of Bacterial IMPDH

The structure of *S. pyogenes* IMPDH (FIG. 1) provides a new resource to define the distinct characteristics of bacterial and mammalian IMPDH enzymes. Features such as the catalytic motifs, active site flap region and CBS dimer domain are structurally conserved, but show a different pattern of sequence conservation in bacteria and eukaryotes. Analysis of sequence differences in these regions suggests they could contribute to the differential signature of the bacterial and mammalian enzymes. One of these sequence regions is the α G helix (FIG. 2) that forms part of the catalytic pocket. Analysis of sequence alignments for this region (Table 2) indicates a pattern of catalytic residues conserved in all enzymes and a secondary pattern of amino acid conservation associated with either bacterial or eukaryotic IMPDH enzymes. In this region, the pattern of bacterial sequence conservation is superimposed on a pattern of residues highly conserved in IMPDH enzymes from all organisms. These highly conserved residues are involved in IMP binding; the characteristics of which appear to be similar for bacterial and eukaryotic IMPDH enzymes. The existence of distinct bacterial catalytic pocket is supported by site-specific mutants at positions E421 and Y450 (Numbering corresponds to the amino acid sequence of the *S. pyogenes* IMPDH enzyme) that appear to differentially alter the activity of the mammalian and bacterial IMPDH enzymes. Residue Y450 in *S. pyogenes* IMPDH is located at the noncatalytic end of the TIM barrel. However, this region has contacts with another molecule in the tetramer and contributes to the catalytic environment of the adjacent monomer (FIG. 3). Site-specific mutagenesis results show partial retention of activity with an alanine substitution but no activity with an aspartic acid substitution for this residue. Aspartic acid was selected as a replacement on the basis of sequence alignments that show 12 of 13 eucaryotic enzymes contain aspartic acid at the corresponding position (the exception being asparagine in *T. foetus*). The partial activity observed with the Ala replacement suggests Y450 does not have an essential role in catalysis but does contribute to the environment of the catalytic pocket. Further analysis of this region will provide insight into the differences in the environment of the catalytic pocket in bacterial and eucaryotic enzymes and also the role of the tetrameric form of the active enzyme. The E421 in *S. pyogenes* IMPDH is conserved in bacteria while eucaryotic IMPDH enzymes contain glutamine in the corresponding position. In hamster IMPDH, the corresponding residue, Q441, is implicated in

the binding of MPA. Comparison of the residues involved in MPA binding in the hamster enzyme (D274, Ser276, N303, R322, G326, T333, Q441) with the equivalent residues in *S. pyogenes* IMPDH indicates that these residues are largely conserved. The aspartic acid, asparagine, glycine, and threonine residues are identical, but threonine replaces S276 (although serine is present in other bacterial enzymes), and K301 replaces the hamster R322 residue. The most significant change appears to be replacement of E421 with Q441 (interestingly, this residue is part of the active-site flap). Although this suggests that the NAD binding pockets of hamster and bacterial IMPDH differ, a change in activity was not observed upon substitution of glutamine for glutamic acid at position 421. It is possible that this substitution does not affect the observed activity but may alter the sensitivity to MPA.

The active site flap represents another region that could account for the kinetic and biochemical differences between IMPDH enzymes. This flap is present in all IMPDH enzymes and is disordered in all IMPDH structures but may become ordered to upon NAD binding. Sequence comparisons (Table 2) indicate the loop size is conserved but sequence conservation is limited. A conserved feature of this region is the presence of an Arginine next to one or two aromatic residues. Since IMP and NAD bind sequentially to the active site, these residues may bind to the phosphate or the adenine or nicotinamide ring thereby ordering the active site. The sequence heterogeneity observed in this flap region may also account for the discriminatory features of bacterial and mammalian IMPDH enzymes.

The finger region and the CBS dimer domain are not involved in catalysis but are found in all IMPDH enzymes. These regions show little sequence conservation but have been structurally conserved. The finger structure is composed of two anti-parallel β -strand structures stabilized by hydrogen bonding and interactions with the β L region (FIG. 2). The CBS dimer domain contains two CBS motifs arranged on a pseudo-dyad axis. In other proteins (e.g. cystathionine-beta-synthase and chloride channel proteins), mutations in these domains are associated with pathologic consequences. It has also been suggested (Nimmessger et al., 1996) that these domains may be involved in cytoplasmic targeting or other regulatory functions. In either case, the metabolic expenditure required for conservation of these structures suggests an underlying functional role.

A unique aspect of the *S. pyogenes* IMPDH structure is that it allows examination of the initial stage of the catalytic cycle. IMP does not form a covalent bond in the absence of NAD. Covalent bond formation requires reorientation of the hypoxanthine ring and nucleophilic attack on C2 by Cys310. This suggests that NAD may have multiple roles as hydride acceptor, substrate activator, and also in contributing to the structure of the active site pocket. NAD binding likely initiates realignment of the hypoxanthine ring and also facilitates the electron shift with the ring required for formation of the thioimidate intermediate.

The structure of *S. pyogenes* IMPDH allows for a detailed comparison of the eukaryotic and bacterial enzymes and provides the basis for an explanation for the unique properties of the bacterial enzymes. This knowledge aids the design of inhibitors that specifically target bacterial IMPDH enzymes.

Determination of Bacterial IMPDH Crystal Structure

The crystal structure of *S. pyogenes* IMPDH was determined at 1.9 Å resolution by replacing all methionine residues in the enzyme with selenomethionine and applying MAD phasing methods (Hendrickson, 1991). The IMPDH

crystals were tetragonal (space group I422, $a=b=151.49$ Å, $c=101.67$ Å, $\alpha=\beta=\gamma=90^\circ$) and contained one 53 kDa monomer per asymmetric unit. The enzyme contains 13 methionine residues: a potential 13 selenium sites (Table 3). Data were collected at three x-ray energies: at the peak and edge energies of the selenium absorption spectrum, and at a lower energy far from the edge. The initial model of the α/β barrel core (amino acid residues 15–90 and 222–460) was obtained by molecular replacement using a search model derived from the atomic coordinates of IMPDH from *T. foetus* (Whitby et al., 1997). These phases were sufficient to permit location of 6 selenium sites. Four rounds of phase development, in which the selenium sites were refined against the three data sets in program MLPHARE (Otwinowski, 1991), permitted location of the remaining selenium atoms in different Fourier maps. The electron density map used for interpretation of this structure was phased by MLPHARE with all 13 selenium sites. The figure of merit (FOM) for this phasing calculation was 0.64 (Table 4); the phasing power was 2.1 for all data between 10–2.5 Å resolution. Solvent flattening and density modification (Cowtan, 1994) further improved the electron density map (FOM=0.72), which at this point was clear enough to trace almost all of the main peptide chain and most side chains (FIG. 4). Registration of the sequence was made easy because methionine residues could be identified with the known selenium positions. The model was refined with the program CNS (Brünger, et al., 1998), which significantly improved the interpretation of several regions in the model that were initially ambiguous. The model disclosed herein contains 3,992 nonhydrogen atoms, from residues 2–401 and 416–492, in two distinct domains. The crystallographic R-factor is 23.2% (R-free: 26.1%) for all reflections between 6 and 1.9 Å resolution (Table 5). The current model contains 422 water molecules with an average B factor for all nonhydrogen protein atoms of 37.5 Å (Table 5). This structure is significantly more complete (97%) and of higher resolution (1.9 Å) than those reported for IMPDH from Chinese hamster (Sintchak et al., 1996) (85%, 2.3 Å) and *T. foetus* (Whitby et al., 1997) (68%, 2.3 Å). The map also contains clearly defined electron density for the IMP substrate, bound in the catalytic site.

Catalytic Domain of Bacterial IMPDH

The *S. pyogenes* IMPDH tetramer is composed of four identical subunits where each monomer has a two-domain structure (FIG. 1a). The catalytic domain (amino acid residues 2–92 and 224–492) forms the interior core of the active tetrameric enzyme and is approximately 40×40×50 Å. This domain contains the catalytic site that is positioned near the tetramer four-fold at the subunit interface (FIG. 1b). This location places access to the active site on the same face of the tetramer. The CBS dimer domain (residues 93–223, approximately 20×20×30 Å) is on the active site face and projects outward from the core of the tetrameric unit placing this domain in the corner of the square formed by E162.

The core of the catalytic domain (FIG. 2a) is formed by an α/β barrel structure that provides a scaffold for the attachment of additional structural and catalytic moieties and the CBS dimer domain. This core region contains a series of eight parallel α/β motifs with the active site near the C-terminus of the β -strands (FIG. 2b). The number and relative location of the barrel structures in *S. pyogenes* IMPDH are similar to that reported for the Chinese hamster (Sintchak et al., 1996) and *T. foetus* (Whitby et al., 1997) IMPDH and for other nicotinamide-dependent oxidoreductases. However, in IMPDH the phosphate-binding site is occupied by IMP rather than by the phosphate of the NAD

or NADP cofactors as seen in the other nicotinamide dependent oxidoreductases.

The β -strand structures and the interior residues of the helices are hydrophobic with very few water molecules observed in the interior of the α/β barrel structure. This hydrophobic environment and the network of hydrogen bonds provide a stable scaffold to anchor the functional and catalytic motifs. Examination of the sequence conservation for IMPDH representatives from the three kingdoms suggests a limited sequence conservation of the α/β barrel core structure relative to the high level of conservation observed for residues forming the catalytic site pocket. The sequence conservation of α/β barrel core is restricted to residues adjacent to the active site pocket and to a region representing the junction between the catalytic and CBS dimer domains.

Several large structural and catalytic protrusions connect the β -strands and α -helices of the α/β barrel surface. The distal face of the α/β barrel (furthest from the IMP binding pocket) provides for entry of the N-terminus (strand β 1). The CBS dimer domain is attached through helix α 2 and strand β 3. Connections between the remaining α/β motifs are short (2–5 amino acid residues) and characterized by a preponderance of proline, glycine and hydrophobic residues. The C-terminal region exits from helix α 8 and is located on the opposite face of the tetramer from the N-terminus.

The protrusions on the proximal face of the α/β barrel scaffold range in size from 3–67 residues and define the character of the active site. Three of the barrel connections (β 1/ α 1, β 6/ α 6, and β 7/ α 7) show greater than a 50% amino acid sequence conservation for IMPDH proteins representing the three kingdoms. The β 8/ α 8 protrusion is the largest (67 residues) of the proximal face motifs and contains the “finger” structure (β J and β K, FIGS. 1b, 2a), short helices α I and α J, strand β M, and regions that have a role in catalysis and that interact with other IMPDH monomers in the tetramer. This protrusion sequence is also highly conserved with regional sequence conservation of 60–80% in three distinct 10-amino acid residue segments. A distinct feature of this region is a “flap” (residues 396–419) on one edge of the active site that apparently projects into the solvent. This flap has been suggested to function by potentially folding over the catalytic pocket controlling access to and ordering the active site. (Whitby et al., 1997) This structure is similar to the active site flap involved in the catalytic mechanism of lactate dehydrogenase (Holbrook et al., 1975). In the *S. pyogenes* IMPDH 1.9 Å structure, 14 residues in this loop remain disordered in the presence of substrate in the active site and also in IMPDH crystals containing product, transition state analogue complexed with MPA (Sintchak et al., 1996; Whitby et al., 1997. This persistent disorder suggests that NAD binding may be critical for structuring the flap; a suggestion supported by the resistance of this region to proteolysis acquired by NAD binding (Nimmegem et al., 1996). This also suggests that MPA binding does not involve an interaction with this flap and does not entirely mimic NAD binding. These features suggest this flap may be important in mediating NAD binding specificity in the active site and may be responsible for some of the kinetic differences of IMPDH enzymes from bacteria and eukaryotes.

CBS Dimer Domain

The CBS dimer domain contains residues 94–223 with an approximate size of 20×20×30 Å. A CBS domain was originally identified in cystathionine- β -synthase and proposed as a regulatory element since mutations lead to the human disease homocystinuria (Bateman, 1997). The CBS dimer domain is composed of two CBS motifs arranged approximately on a two-fold dyad axis (FIG. 5). Each CBS

motif has the characteristic sheet/helix/sheet/sheet/helix topology. This is the first reported complete structure for this domain. The CBS dimer domain does not interact with the other subunits in the active tetrameric enzyme and may not be required for activity (Sintchak et al., 1996; Zhou et al., 1997). Although the amino acid sequence of this domain is not as well conserved as that of the catalytic domain, all IMPDH proteins contain this domain.

In *S. pyogenes* IMPDH, these domains form a minibarrel structure that has a hydrophobic core region with hydrophilic residues on the surface. Among bacteria, the degree of amino acid conservation is highest in the E and F β -strands (FIG. 2a) that span the interior of the CBS dimer domain and provide a resource of hydrophobic residues. The α -helices on the exterior maintain the character of this domain with hydrophilic residues on the exterior surfaces and hydrophobic residues positioned on the interior. There is a well-defined cleft between CBS motifs (approximately 15 Å in length) between the CBS motifs; this cleft may function as a potential binding site for regulatory molecules. There is not a defined role for CBS motifs in bacteria but in eukaryotic organisms they may have a role in cytoplasmic targeting, protein-protein interactions or protein regulation (Bateman, 1997). In view of these unique characteristics, it is possible that, in bacteria, this domain may possess a species-specific regulatory role.

Tetramer Organization

S. pyogenes IMPDH is a perfect tetramer with the four subunits related by a crystallographic four-fold axis. Similarly, the structures reported for Chinese hamster (Sintchak et al., 1996) and *T. foetus* (Whitby et al., 1997) IMPDH also display four-fold symmetry. The scope of these structures encompass the apo-enzyme and several substrate, product, and inhibitor complexes

The tetrameric structure of IMPDH is stabilized by monomeric contacts with each of the adjacent subunits. Many of these contacts originate from interactions of the N- and C-terminal regions of the adjacent monomeric units. The subunit interactions can be arranged into three groups differing in their proximity to the catalytic site and level of amino acid sequence conservation. In one group, the first 14 residues of the N-terminus project approximately 20 Å from the protein core (FIGS. 1a, 2b) and interact with surface residues of an adjacent IMPDH monomer. This regional contact is distal from the catalytic site and involves residues 3–12 of the N-terminus that interact with β -sheet residues 465–468 of an adjacent subunit. The interaction involves hydrogen bonds and salt bridges between amino acid regions that display little sequence conservation. Another loop (residues 22–30), is involved in subunit contacts with the adjacent IMPDH molecule and also forms part of the active site pocket of the adjacent subunit. This region directly contacts the α H helix that is involved in binding IMP and the α 4 helix of the α/β motif implicated in the binding of NAD (Sintchak et al., 1996). This region contains amino acid residues that are conserved in IMPDH enzymes from the three kingdoms. The sequence conservation and proximity to the active site suggests these interactions may indirectly mediate catalytic activity and account for the tetrameric character of the active enzyme. Additional subunit contacts originate from β -strand β K and residues 479–484 in an adjacent IMPDH monomer. These regions are on the exterior of the tetramer approximately 20 Å from the IMP binding site and display an amino acid sequence conservation that is restricted to a specific phylogenetic group.

A feature observed in the tetramer structure is the projection of an extended region from the C-terminal face of

each monomer subunit (FIG. 1b). These “fingers” are observed in all IMPDH enzymes for which structural information is available. This region of 12 amino acids forms two anti-parallel β -strand structures stabilized by hydrogen bonding and interactions with the β L region (FIG. 2a). Interestingly, in all IMPDH enzymes, this region contains at least two solvent-exposed hydrophobic residues. Other than a predominance of aromatic amino acids, there is little sequence conservation even within the specific phylogenetic domains. However, the β -strand structure of the fingers is preserved and amino acid residues at the base of the fingers are conserved for all phylogenetic groups. The conservation of this structure may have functional consequences for the interaction of the tetramer with other IMPDH complexes or cellular proteins.

Catalytic Site and Implication for the Mechanism of Bacterial IMPDH

IMP dehydrogenase catalyzes the oxidation of inosine 5'-monophosphate to xanthosine 5'-monophosphate with the concomitant reduction of NAD to NADH. IMP is bound at one end of the barrel with the other end blocked by the β B/ β C sheet (FIG. 2a). Short helices H, J, and I are structural motifs containing many of the active site residues. During the reaction the hydride is transferred from the C2 carbon of the hypoxanthine ring to NAD and an oxygen atom is substituted in the C2 position resulting in the formation of xanthosine.

The high-resolution (1.9 Å) crystal structure of *S. pyogenes* IMP dehydrogenase allows examination of the catalytic site in greater detail than it was possible previously. The enzyme contains the inosine monophosphate substrate bound into the pocket located near the surface of the α / β -barrel structure. The inosine ribose and phosphate moieties are highly coordinated by protein (FIG. 3a). The sugar is in the C2'-endo-conformation and its 2'- and 3'-hydroxyls are hydrogen-bonded with the Asp343 residue as well as with a water molecule that through a water relay system connects with N3 of the hypoxanthine ring (FIG. 3a). The phosphate group is anchored in its site by a number of amino acid side chains (S308, S367 and Y390) and three main chain nitrogens (G345, G366 and S367). The remaining hydrogen-binding potential of the phosphate oxygens is realized with water molecules.

The conformation of the glycosidic torsion angle of the bound nucleotide is anti and the hypoxanthine ring interacts with the ribose and the phosphate moiety only through water mediated interactions and appears to be free to rotate around the glycosidic bond (FIG. 3a). This conformation places H2 of hypoxanthine ring (which is transferred to NAD in the reaction) in a position unobstructed by the rest of the molecule to facilitate the reaction. N1, N7 and O6 of the hypoxanthine ring are hydrogen bonded to the main chain carbonyl of E421 and main chain nitrogen of M393 and G394, respectively. However, N3 is not involved in an interaction with protein and only weakly with solvent. There are van der Waals contacts between the hypoxanthine ring and the Ile309 residue.

Cysteine 310 has been identified previously as a key residue in catalysis (Huete-Pérez et al, 1995; Antonino et al, 1994). The ability of the thiol residue to ionize appears to be critical for the reaction involving nucleophilic attack. The hydroxyl of T312 is in position (3.3 Å) to extract a hydrogen from C310 and therefore ionize the cysteine residue. This is consistent with mutagenesis studies that show that substitution of this residue abolishes enzyme activity (Sintchak et al, 1996). The sulfur atom is located above the plane of the hypoxanthine ring, 3.3 Å from the C2 atom, and is not

covalently attached to the ring (FIG. 5c). The C310 is in a position for a nucleophilic attack on C2 carbon once the activation of the CysTEINE residue is accomplished and the orientation of the hypoxanthine ring is adjusted (it can swivel around glycosidic bond). The formation of a tetrahedral intermediate has been proposed (Xiang et al, 1997). However, the present inventions shows that IMPDH does not form a covalent bond with the substrate in the absence of the NAD cofactor. Therefore a cofactor plays not only the role of hydride acceptor but also appears to complete the structure of the catalytic pocket. Initiation of a reaction cycle requires alignment of the hypoxanthine and nicotinamide rings in near parallel fashion and positioning of the C2 of hypoxanthine ring in close contact with C4 on the beta face of nicotinamide ring (Xiang et al., 1997). This places the amide moiety of NAD near the N3 nitrogen of hypoxanthine. Such a configuration may facilitate the electron shift within the hypoxanthine ring required for formation of the thioimidate intermediate. Therefore, it appears that the cofactor may play a role in activation of the substrate. This mechanism is in striking contrast with results obtained with halogenated derivatives of IMP. Human IMPDH catalyses the dehalogenation of 2-fluoro- and 2-chloroinosine 5'-monophosphate in the absence of NAD (Antonino et al., 1994). This suggests that, although the C310 activation system is in place, the reaction does not proceed with IMP because hydride is a much poorer leaving group than chlorine and fluorine and the binding of NAD is required.

The structure of the hamster IMPDH has been reported (Sintchak et al., 1996). This structure contains the hypoxanthine ring covalently bound to C331 (equivalent to C10 in our structure) and an inhibitor MPA bound to the active site. It appears that the hamster IMPDH structure represents the covalent thioimidate intermediate of the reaction in which MPA, an uncompetitive inhibitor, prevents the hydrolysis of the thiopurine covalent intermediate as was suggested previously by Link and Straub (Link et al., 1996) Therefore MPA restricts the access of the solvent molecules and blocks subsequent steps of the reaction. This observation also suggests that the hydrolysis of the thioimidate intermediate is mediated by an activated water molecule originating from the NAD site. In the *S. pyogenes* IMPDH structure, two water residue were located that are potential candidates for nucleophilic attack on the thioimidate (FIG. 3b). Several residues (E421, T312, and Y450 from and adjacent subunit) in the active site pocket can act as activators of this water molecule. Because MPA can stabilize the thioimidate intermediate in the human enzyme (Sintchak et al., 1996), hydrolysis of thioimidate must be several orders of magnitude slower than the dissociation of NADH. These results are consistent with the mechanism proposed by Wang et al. (1996)

The binding of NAD to IMPDH has not been structurally characterized. However, a structure has been reported for the hamster enzyme complexed with MPA (Sintchak et al., 1996), an uncompetitive inhibitor of mammalian IMPDH enzymes. MPA has been suggested to inhibit the hamster enzyme by mimicking the nicotinamide portion of NAD and blocking access of a catalytic water molecule (Sintchak et al., 1996). Comparison of the residues involved in MPA binding in the hamster enzyme (D274, S276, N303, R322, G1326, T333, Q441) with the equivalent residues in *S. pyogenes* IMPDH indicates these residues are largely conserved. The Asparagine, Aspartate, Glycine, and Threonine residues are identical, Threonine replaces S276 (although Serine is present in other bacterial enzymes), and Lys301 replaces the hamster R322 residue. The most significant

change appears to be replacement of E421 with Q441. Interestingly, this residue is part of the active site flap that is ordered. This suggests that the NAD binding pocket is different in bacterial IMPDH, however the mechanism of If oxidation remains the same.

MATERIALS AND METHODS

Site-specific Mutants.

To validate the role of specific residues in catalysis and to provide a basis for comparing the bacterial and mammalian enzymes, several point mutants were constructed. The sites for mutation were selected on the basis of previous studies suggesting a catalytic role for the region and supported by information derived from the *S. pyogenes* IMPDH crystal structure. One region targeted for site-specific mutagenesis was the active site flap. This flap is present in all IMPDH enzymes and is disordered in the *S. pyogenes* IMPDH structures and in the IMPDH structures from hamster and *T. foetus*. Although this region has not been previously implicated in the catalysis mechanism of IMPDH enzymes, the presence of a conserved RY(FY) motif and the similarities to the flap region in lactate dehydrogenase (Holbrook et al., 1975) suggest a potential role in catalysis. Mutation of R406 to alanine in this flap region results in a complete loss of enzyme activity (Table 6) as might be expected for a residue conserved in all.

TABLE 6

Mutant	Site-specific mutants of <i>S. pyogenes</i> IMPDH			Relative specific activity of purified
	Corresponding residue in mammalian	Region		
	IMPDH	Location	Function	
Arg406 @Ala	Arg	Active site flap	Catalysis	No activity
Tyr450 @Asp	Asp	Helix 8, TIM barrel	Unknown	No activity
Tyr450 @Ala	Asp	Active site	Unknown	0.25
Glu421 @Gln	Gln	α_7/β_L Loop	NAD binding region	1.0

IMPDH enzymes. This loss of activity confirms the importance of the active site flap in catalysis. Since there is little sequence conservation of this region, this structure is an attractive target for specific inhibitors.

The catalytic mechanism of *S. pyogenes* IMPDH involves the hydrolysis of a thioimidate intermediate that we believe is mediated by an activated water molecule originating from the NAD site. In the *S. pyogenes* IMPDH structure, we have located two water residues that are potential candidates for nucleophilic attack on the thioimidate. Tyrosine 450 originating from an adjacent subunit, is a residue in the active site pocket that can act as an activator of one of these water molecules. This residue is located at the noncatalytic end of a conserved helix (Helix 8) that forms the TIM barrel core. Replacement of Y450 with aspartic acid or alanine (Table 6) results in substantial loss of enzyme activity. Approximately 25% activity is retained for an alanine replacement, but substitution of aspartic acid results in a loss of enzyme activity. This region is conserved in the IMPDH enzymes, but the sequence pattern is different in bacteria and eukaryotes, suggesting this region may contribute to the differential signature of the bacterial and mammalian enzymes.

The NAD binding region (between the α_7/β_L loop) was also selected as a target for site-specific mutagenesis. The selection of E421 for mutation was based on an analysis of sequence differences at residues corresponding to or near amino acids identified as MPA binding sites in human IMPDH. The conserved glutamate in bacteria is replaced with a conserved glutamine in eukaryotes. This substitution does not alter the apparent activity of *S. pyogenes* IMPDH (Table 6). This result was unexpected since replacement of the corresponding residue in the hamster enzyme (Q441) with alanine results in a significant decrease in activity (Sintchak et al., 1996)

Cloning and Expression of *S. Pyogenes* IMPDH

The coding region of IMPDH was amplified from *S. pyogenes* genomic DNA (provided by Dr. Michael Boyle, Medical College of Ohio, Toledo, Ohio; Genomic DNA from *S. pyogenes* is also available from the American Type Culture Collection [ATCC] as catalogue No. 700294D) using coding region-specific primers and a proofreading polymerase (Pfu). The amplified fragment was cloned into a pET23a (Novagen) expression vector and used to transform BL21 (DE3)lysS bacterial cells. DNA sequencing of the expression constructs validated sequence integrity of the initiation and termination regions. Expression of Streptococcal IMPDH was induced by the addition of IPTG to a concentration of 0.5 mM

The Streptococcal IMPDH enzyme was purified using a modification of the procedure previously described for the human enzymes (Hager et al., 1995). The modified procedure replaces the Blue Sepharose dye column with a Matrex Green resin (Millipore, Bedford, Mass.). Since the enzyme elutes as a broad peak from the dye column, an additional chromatographic procedure was applied to facilitated enzyme concentration and increase purity. Peak fractions from the dye column are diluted with 20 mM Tris-HCL, pH 7.4 and applied to a MonoQ HR10/10 FPLC column (Pharmacia, Piscataway, N.J.). The column was washed with 20 mM Tris-HCl, pH 7.4, 1 mM DTT and the enzyme eluted with a linear gradient of 0.2–0.7 M NaCl in wash buffer.

Purified IMPDH from *S. pyogenes* was characterized by N-terminal sequencing and analyzed by mass spectroscopy to validate as much of the internal protein sequence as is possible. An N-terminal sequence was obtained (Yale Biotechnology Resource Center) for 19 residues corresponding to amino acids 2–20 of the predicted sequence and indicated cleavage of the N-terminal methionine as is commonly observed for proteins expressed in *E. Coli*. Characterization of the purified protein also included matrix-assisted laser desorption ionization mass spectroscopy (MALDI-MS) analysis of the intact and tryptic-digested protein provided by The Biotechnology Resource Laboratory at Yale University. MALDI-MS of the intact protein indicated a molecular weight (MW) of 52,328 similar to the predicted MW of 52,657. In addition to N-terminal sequencing of the intact protein, a tryptic digest of the purified protein was analyzed by MALDI-MS. This analysis provided verification of approximately 60% of the of the internal protein sequence.

Selenomethionyl IMPDH was obtained by growth of the native expression bacterium in M9 medium. Prior to induction of IMPDH expression, de novo methionine synthesis was suppressed by the addition of phenylalanine, valine, threonine, isoleucine, leucine, and lysine to a final concen-

tration of 50 ug/ml. Thirty minutes later, selenomethionine was added to a final concentration of 50 ug/L and IPTG was added 0.25 mM. The induced bacteria were harvested 4–6 h after induction. The purification and crystallization of selenomethionyl IMPDH was as described for the wild-type enzyme and the presence of selenomethionine was verified by amino acid analysis of the purified protein.

Crystallization and Data Collection

Crystals of IMPDH from *S. pyogenes* were grown by the hanging drop method. The reservoir solution was 0.1 M MES (pH 7.2), 1.8 M ammonium sulfate, with 1 mM IMP. The crystals grew in a few days to about 0.1x0.1x0.25 mm (maximum size). Crystals were transferred into a cryo-protectant solvent prepared by the addition of glycerol to the crystallization solution (final glycerol concentration (v/v), 28%). Crystals were flash cooled in liquid nitrogen for all data collections.

Diffraction data were collected on beamline 19ID of the Structural Biology Center at the Advanced Photon Source. The approximate x-ray flux on the sample was 1x10 Ph/sec. Diffraction patterns from IMPDH crystals were collected at 100° K using a 3x3 mosaic CCD area detector (Westbrook et al. 1997) and data were processed by the HKL2000 (Otwinowski et al., 1997) package. Diffraction patterns of the IMPDH crystals exhibited 4/mmm symmetry. Bragg spots with indices other than $(h+k+l)=2n$ were systematically absent. Therefore the space group to which these crystals belong must be I422. The cell dimensions are $a=b=151.49$ Å, $c=101.67$ Å, $\alpha=\beta=\gamma=90^\circ$. Each asymmetric unit of this crystal form contains one monomer; the estimated solvent content is 55% and $V_M=2.79$ Å³/Da.

Crystals for the MAD study were of SeMet IMPDH from *S. pyogenes* complexed with IMP. We recorded three data sets for a single crystal, each at a unique x-ray wavelength ($\lambda_1=1.0781$ Å, $\lambda_2=0.9793$ Å, $\lambda_3=0.9791$ Å, Table 3). The entire time to manipulate the sample and acquire data required less than one hour. The crystal was not oriented in any special way prior to data collection. Data quality is summarized in Table 3. The high-resolution data (1.90 Å) were collected from the same crystal at wavelength $\lambda=1.0332$ Å. Details of the experiments and data quality are summarized in Table 3.

Phasing

Phase analysis for the crystal form was initiated by carrying out molecular replacement (MR), using AMORE (Navaza et al., 1997) and the *T. foetus* atomic coordinates (Whitby et al., 1997) from the Protein Data Bank as a search model. The initial molecular replacement solution of this structure produced phases that were not sufficiently close to the correct values for us to interpret the structure further. However this phase set was sufficiently good to identify 6 of the 13 selenium sites in the structure. These selenium sites were refined by the method discussed by Ramakrishnan and Biou (1997), using the program MLPHARE (Otwinowski, 1991), yielding a phase set which permitted identification of two additional selenium atoms. Further MLPHARE refinement with 8 selenium sites produced phases that permitted location of three additional selenium sites by difference Fourier analysis. The next stage of MLPHARE refinement

against 11 selenium sites produced phases with which the remaining 2 selenium sites were identified. The final round of MLPHARE phasing with all 13 selenium sites (Table 3) produced a map with which interpretation of the model was completed. Phases were improved during subsequent refinement with CNS (Holbrook et al., 1975) (see below) permitting modeling of 97% of the structure.

10 Model Building, and Refinement

All model building was carried out with FRODO (Jones, 1968) on an Evans and Sutherland ESV10 graphics workstation. Relative to the map obtained by molecular replacement, the MAD map obtained with six selenium sites allowed localization of IMP in the active site and corrected several errors in the catalytic domain model. The MAD map calculated with 8 selenium sites allowed modeling of the complete N-terminus (except residue 1), the C-terminus to residue 480, and the CBS dimer domain with the exception of residues 114–169. The MAD map obtained with eleven selenium sites allowed assignment of the C-terminus to residue 490, and decreased the undefined region of the CBS dimer domain to residues 146–162. When all 13 selenium sites were used in the MAD map calculation, it was possible to model the entire molecule, with the exception of residue 1, residues 221–226, the active site flap (residues 402–415) and C-terminal residue 493. CNS refinement improved phases to allow modeling of residues 221–226 in the CBS dimer domain. This model accounts for 97% of the residues predicted from the gene sequence.

Refinement of the initial model against the MAD data was carried out using torsion-angle molecular dynamics (Rice et al., 1994) and the phase restrained MLHL target (Pannu et al., 1998) implemented in CNS (Holbrook et al., 1975). All diffraction data (6.0–1.90 Å) were used throughout the refinement except for a 10% randomly selected test set required for cross-validation of the σ_A values used in the maximum likelihood target and free R calculations. A flat bulk solvent model was implemented in density modification of the initial MAD maps, with the program DM (Cowtan, 1994). At the later stages, σ_A phase-combined maps (Pannu et al., 1998) were calculated, with model phases calculated from the MLHL refined model combined with experimental phases. Alternate cycles of model rebuilding, positional refinement, restrained B-factor refinement, and water placement followed, decreasing the free R-factor from its initial value of 48% to 26.1% and yielding the current R-factor of 23.2% (Table 5). The model has a correlation coefficient (F_a versus F_c) of 95% and an estimated coordinate error of 0.3 Å using the SIGMAA (Read, 1986) software suite. Stereochemical and other refinement parameters are given in Table 4. By PROCHECK (Laskowski et al., 1993) criteria, the model has 91.2% of the main chain torsion angles within the “allowed regions” of the Ramachandran plot and 8.8% within the “additional allowed regions”.

Coordinates

65 The coordinates of the crystalline IMPDH molecule (Table 7) have been deposited in the Brookhaven Protein Data Bank under accession number 1ZFJ.

TABLE 2

Catalytic Region				
Bacteria	PGSIC	TTRVVAGVGV	(SEQ ID NO: 1)	<i>Streptococcus pyogenes</i>
	PGSIC	TTRVVAGVGV	(SEQ ID NO: 2)	<i>Bacillus subtilis</i>
	PGSIC	TTRIVTGVGV	(SEQ ID NO: 3)	<i>Escherichia coli</i>
	PGSIC	TTRVVAGVGV	(SEQ ID NO: 4)	<i>Bacillus subtilis</i>
	PGSIC	TTRVVAGVGV	(SEQ ID NO: 5)	<i>Mycobacterium tuberculosis</i>
Eucarya	SGSIC	ITQEVLCACGR	(SEQ ID NO: 6)	<i>Homo sapiens</i>
	SGSIC	ITQEVLCACGR	(SEQ ID NO: 7)	<i>Mus musculus</i>
	SGSIC	ITQEVLCACGR	(SEQ ID NO: 8)	<i>Arabidopsis thaliana</i>
	SGSIC	ITQEVLCACGR	(SEQ ID NO: 9)	<i>Leishmania donovani</i>
	TGSIC	ITQKVMACGR	(SEQ ID NO: 10)	<i>Saccharomyces cerevisiae</i>
	SGSIC	ITQEVMACGR	(SEQ ID NO: 11)	<i>Drosophila melanogaster</i>
Active Site Flap				
Bacteria	MA.....KG	SSDRYFQ.SD	NAADKLVPEG	(SEQ ID NO: 12) <i>Streptococcus pyogenes</i>
	MS.....KG	SSDRYFQ.SD	NAADKLVPEG	(SEQ ID NO: 13) <i>Bacillus subtilis</i>
	MK.....KG	SSDRYFQGSV	NEANKLVPEG	(SEQ ID NO: 14) <i>Escherichia coli</i>
	ME.....KG	SKDRYFQ...	EENKKFVPEG	(SEQ ID NO: 15) <i>Bacillus subtilis</i>
	MRGRGGATS	SKDRYFADDA	LSEDKLVPEG	(SEQ ID NO: 16) <i>Mycobacterium tuberculosis</i>
Eucarya	MD....KHLS	SQNRYFSEAD	KIK...VAQG	(SEQ ID NO: 17) <i>Homo sapiens</i>
	MD....KHLS	SQNRYFSEAD	KIK...VAQG	(SEQ ID NO: 18) <i>Mus musculus</i>
	MERGDAGKAA	MSRYHNMED	KMK...VAQG	(SEQ ID NO: 19) <i>Arabidopsis thaliana</i>
	MQKTGTGKNA	STSRYFSES	SVL...VAQG	(SEQ ID NO: 20) <i>Leishmania donovani</i>
	MTKG.....	SDQRYLGDQT	KLK...IAQG	(SEQ ID NO: 21) <i>Drosophila melanogaster</i>
	M....SQGKE	SGKRYLSENE	AVQ...VAQG	(SEQ ID NO: 22) <i>Saccharomyces cerevisiae</i>

TABLE 3

Crystal and MAD Data Collection Parameters for IMPDH				
				30
Crystal Parameters				
Unit Cell	a = b = 151.49 Å, c = 101.67 Å, $\alpha = \beta = \gamma = 90^\circ$			
Space Group	I422			35
MW	53,328			
Mol/AU	1			
Se-Met/AU	13			
MAD Data Collection (SeMet IMPDH)				
				40
Oscillation Angle	1°			
Oscillation Range	90°			
Exposure time/degree	5 sec			
	Edge (λ_2)	Peak (λ_3)	Remote (λ_1)	45
Wavelength (Å)	0.9793	0.9791	1.0781	
Resolution (Å)	2.5	2.5	2.5	
Total observations	283910	276365	272576	
Unique reflections	20633	20627	20686	50
Redundancy	6.9	6.7	6.6	
Completeness	99.7	99.7	99.6	
R _{merge} (%)	7.7	9.6	5.9	
High Resolution Data Set				
				55
Oscillation angle	1°			
Oscillation range	90°			
Exposure time/degree	8 sec			
Wavelength (Å)	1.0332			
Resolution (Å)	30–1.90			60
Total observations	263,355			
Unique reflections	44,921			
Completeness (%)	96.5			
R _{merge} (%)	6.8			65

TABLE 4

Summary of MLPHARE Phasing								
Resolution (Å)	Acentric			Centric			All	
	No	FOM ^a	Phasing ^b	No	FOM	Phasing	No	FOM
			power			power		
7.27	631	0.56	1.71	231	0.51	1.71	862	0.55
5.71	759	0.79	3.35	167	0.71	3.03	926	0.78
4.71	1188	0.79	3.18	208	0.68	2.40	1396	0.77
4.00	1719	0.77	2.86	242	0.65	1.92	1961	0.76
3.48	2337	0.75	2.42	265	0.65	1.82	2602	0.74
3.08	3053	0.70	2.13	283	0.60	1.49	3336	0.69
2.76	3860	0.62	1.78	270	0.54	1.09	4130	0.61
2.5	4642	0.45	1.21	207	0.41	0.81	4849	0.45
Total	18189	0.64	2.02	1873	0.60	1.63	20062	0.64

^aFigure of Merit is a measure of the relative reliability of a phase based on the consistency of the MIR analysis from one derivative to the next. The maximum value is 1.0.

^bMAD phasing power is defined:

$\{(|F_{hi} - F_{hl}|^2) / P_{\lambda_i \rightarrow \lambda_i}(\phi) (|F_{\lambda_i}| e^{i\phi} + F_{hi} - F_{hl} - |F_{\lambda_i}|)^2 d\phi\}^{1/2}$ computed for individual lack-of-closure expressions between the reflections of the reference wavelength λ_i , its Friedel mate, and the Bijvoet pairs measured at the other wavelengths (F_{hi}). $P_{\lambda_i \rightarrow \lambda_i}(\phi)$ is the corresponding phase probability distribution.

25

TABLE 5

Refinement Statistics from CNS and PROCHECK	
Resolution range (Å)	6.0–1.90
Reflections	40,828
σ cutoff	none
R-value ¹ (%)	23.2
Free R-value ² (%)	26.1 (4095 reflections)
Completeness (%)	88.6
Number of nonhydrogen atoms	3997
Number of solvent molecules	422
Number of IMP	1
Luzzati coordinate error (5.0–1.9 Å)	0.34 Å
σ_A -coordinate error (5.0–1.9 Å)	0.30 Å
Bond length deviation	0.0059 Å
Bond angle deviation	1.3029°
Improper angle deviation	0.745°

TABLE 5-continued

30

Refinement Statistics from CNS and PROCHECK	
Dihedrals deviation	21.702°
Average B-factor:	
Protein atoms	37.5 Å ²
Catalytic domain	34.4 Å ²
CBS dimer domain	43.4 Å ²
Solvent atoms	50.1 Å ²
Residues in core phi-psi regions	91.2%
Residues in disallowed regions	0.0%

35

$${}^1R\text{-value} = \frac{|F_{\text{obs}}| - \kappa |F_{\text{calc}}|}{|F_{\text{obs}}|}$$

45

²Free R-value is the R-value obtained for a test set of reflections (10% of the diffraction data) not used during refinement or σ_A calculations.

TABLE 7

HEADER	DEHYDROGENASE	MAR. 29, 1999	1ZFJ
TITLE	INOSINE MONOPHOSPHATE DEHYDROGENASE (IMPDH; EC 1.1.1.205)		
TITLE	2 FROM <i>STREPTOCOCCUS PYOGENES</i>		
COMPND	MOL_ID: 1;		
COMPND	2 MOLECULE: INOSINE MONOPHOSPHATE DEHYDROGENASE;		
COMPND	3 CHAIN: A;		
COMPND	4 FRAGMENT: CATALYTIC DOMAIN, CBS DOMAIN;		
COMPND	5 EC: 1.1.1.205;		
COMPND	6 ENGINEERED: YES;		
COMPND	7 BIOLOGICAL_UNIT: TETRAMER		
SOURCE	MOL_ID: 1;		
SOURCE	2 ORGANISM_SCIENTIFIC: <i>STREPTOCOCCUS PYOGENES</i> ;		
SOURCE	3 EXPRESSION_SYSTEM: <i>STREPTOCOCCUS PYOGENES</i> ;		
SOURCE	4 EXPRESSION_SYSTEM_STRAIN: <i>ESCHERICHIA COLI</i>		
KEYWDS	IMPDH, DEHYDROGENASE, CBS DOMAINS		
EXPDTA	X-RAY DIFFRACTION		
AUTHOR	R. ZHANG, G. EVANS, F. J. ROTELLA, E. M. WESTBROOK, D. BENO, E. HUBERMAN,		
AUTHOR	2 A. JOACHIMIAK, F. R. COLLART		

TABLE 7-continued

JRNL	AUTH	R. ZHANG, G. EVANS, F. J. ROTELLA, E. M. WESTBROOK, D. BENO,
JRNL	AUTH	2 E. HUBERMAN, A. JOACHIMIAK, F. R. COLLART
JRNL	TITL	CHARACTERISTICS AND CRYSTAL STRUCTURE OF BACTERIAL
JRNL	TITL	2 IMP DEHYDROGENASE
JRNL	REF	TO BE PUBLISHED
JRNL	REFN	0353
REMARK	1	
REMARK	2	
REMARK	2	RESOLUTION. 1.90 ANGSTROMS.
REMARK	3	
REMARK	3	REFINEMENT.
REMARK	3	PROGRAM : CNS 0.3
REMARK	3	AUTHORS : BRUNGER, ADAMS, CLORE, DELANO, GROS, GROSSE-
REMARK	3	: KUNSTLEVE, JIANG, KUSZEWSKI, NILGES, PANNU,
REMARK	3	: READ, RICE, SIMONSON, WARREN
REMARK	3	
REMARK	3	REFINEMENT TARGET : NULL
REMARK	3	
REMARK	3	DATA USED IN REFINEMENT.
REMARK	3	RESOLUTION RANGE HIGH (ANGSTROMS) : 1.9
REMARK	3	RESOLUTION RANGE LOW (ANGSTROMS) : 6.0
REMARK	3	DATA CUTOFF (SIGMA(F)) : 0.0
REMARK	3	OUTLIER CUTOFF HIGH (RMS(ABS(F))) : 986591.3
REMARK	3	COMPLETENESS (WORKING + TEST) (%) : 88.2
REMARK	3	NUMBER OF REFLECTIONS : 39729
REMARK	3	
REMARK	3	
REMARK	3	FIT TO DATA USED IN REFINEMENT.
REMARK	3	CROSS-VALIDATION METHOD : THROUGHOUT
REMARK	3	FREE R VALUE TEST SET SELECTION : RANDOM
REMARK	3	R VALUE (WORKING SET) : 0.232
REMARK	3	FREE R VALUE : 0.263
REMARK	3	FREE R VALUE TEST SET SIZE (%) : 10.0
REMARK	3	FREE R VALUE TEST SET COUNT : 3980
REMARK	3	ESTIMATED ERROR OF FREE R VALUE : 0.004
REMARK	3	
REMARK	3	FIT IN THE HIGHEST RESOLUTION BIN.
REMARK	3	TOTAL NUMBER OF BINS USED : 6
REMARK	3	BIN RESOLUTION RANGE HIGH (A) : 1.9
REMARK	3	BIN RESOLUTION RANGE LOW (A) : 2.01
REMARK	3	BIN COMPLETENESS (WORKING + TEST) (%) : 70.8
REMARK	3	REFLECTIONS IN BIN (WORKING SET) : 4706
REMARK	3	BIN R VALUE (WORKING SET) : 0.357
REMARK	3	BIN FREE R VALUE : 0.368
REMARK	3	BIN FREE R VALUE TEST SET SIZE (%) : 10.2
REMARK	3	BIN FREE R VALUE TEST SET COUNT : 534
REMARK	3	ESTIMATED ERROR OF BIN FREE R VALUE : 0.02
REMARK	3	
REMARK	3	NUMBER OF NON-HYDROGEN ATOMS USED IN REFINEMENT.
REMARK	3	PROTEIN ATOMS : 3544
REMARK	3	NUCLEIC ACID ATOMS : 0
REMARK	3	HETEROGEN ATOMS : 23
REMARK	3	SOLVENT ATOMS : 499
REMARK	3	
REMARK	3	B VALUES.
REMARK	3	FROM WILSON PLOT (A**2) : 21.9
REMARK	3	MEAN B VALUE (OVERALL, A**2) : NULL
REMARK	3	OVERALL ANISOTROPIC B VALUE.
REMARK	3	B11 (A**2) : 9.84
REMARK	3	B22 (A**2) : 9.84
REMARK	3	B33 (A**2) : -19.7
REMARK	3	B12 (A**2) : 0.0
REMARK	3	B13 (A**2) : 0.0
REMARK	3	B23 (A**2) : 0.0
REMARK	3	
REMARK	3	ESTIMATED COORDINATE ERROR.
REMARK	3	ESD FROM LUZZATI PLOT (A) : 0.29
REMARK	3	ESD FROM SIGMAA (A) : 0.33
REMARK	3	LOW RESOLUTION CUTOFF (A) : 5.0
REMARK	3	
REMARK	3	CROSS-VALIDATED ESTIMATED COORDINATE ERROR.
REMARK	3	ESD FROM C-V LUZZATI PLOT (A) : 0.32
REMARK	3	ESD FROM C-V SIGMAA (A) : 0.37
REMARK	3	
REMARK	3	RMS DEVIATIONS FROM IDEAL VALUES.
REMARK	3	BOND LENGTHS (A) : 0.018
REMARK	3	BOND ANGLES (DEGREES) : 2.2
REMARK	3	DIHEDRAL ANGLES (DEGREES) : 21.8
REMARK	3	IMPROPER ANGLES (DEGREES) : 2.37

TABLE 7-continued

```

REMARK 3
REMARK 3 ISOTROPIC THERMAL MODEL : RESTRAINED
REMARK 3
REMARK 3 ISOTROPIC THERMAL FACTOR RESTRAINTS. RMS SIGMA
REMARK 3 MAIN-CHAIN BOND (A**2) : 1.21 ; 1.5
REMARK 3 MAIN-CHAIN ANGLE (A**2) : 1.92 ; 2.0
REMARK 3 SIDE-CHAIN BOND (A**2) : 1.98 ; 2.0
REMARK 3 SIDE-CHAIN ANGLE (A**2) : 3.02 ; 2.5
REMARK 3
REMARK 3
REMARK 3 BULK SOLVENT MODELING.
REMARK 3 METHOD USED : NULL
REMARK 3 KSOL : NULL
REMARK 3 BSOL : NULL
REMARK 3
REMARK 3 NCS MODEL : NULL
REMARK 3
REMARK 3 NCS RESTRAINTS. RMS SIGMA/WEIGHT
REMARK 3 GROUP 1 POSITIONAL (A) : NULL ; NULL
REMARK 3 GROUP 1 B-FACTOR (A**2) : NULL ; NULL
REMARK 3
REMARK 3 PARAMETER FILE 1 : PROTEIN_REP.PARAM
REMARK 3 PARAMETER FILE 2 : WATER_REP.PARAM
REMARK 3 PARAMETER FILE 3 : IMP.PAR
REMARK 3 TOPOLOGY FILE 1 : PROTEIN.TOP
REMARK 3 TOPOLOGY FILE 2 : WATER.TOP
REMARK 3 TOPOLOGY FILE 3 : IMP.TOP
REMARK 3
REMARK 3 OTHER REFINEMENT REMARKS: BULK SOLVENT MODEL USED
REMARK 4
REMARK 4 1ZFI COMPLIES WITH FORMAT V. 2.3, JUL. 9, 1998
REMARK 7
REMARK 7 S. PYOGENES IMPDH IS A TETRAMER WITH ITS FOUR SUBUNITS
REMARK 7 RELATED BY A CRYSTALLOGRAPHIC FOURFOLD AXIS. EACH MONOMER
REMARK 7 HAS A TWO-DOMAIN STRUCTURE: A CATALYTIC DOMAIN
REMARK 7 (AMINO ACID RESIDUES 2-92 AND 224-492) FORMING THE INTERIOR
REMARK 7 CORE OF THE ACTIVE TETRAMERIC ENZYME AND A CBS DIMER DOMAIN
REMARK 7 (RESIDUES 93-223) PROJECTING OUTWARD FROM THE CORNERS OF
REMARK 7 THE SQUARE. THE CBS DESIGNATION ARISES FROM THE ORIGINAL
REMARK 7 IDENTIFICATION OF THIS FOLDING MOTIF IN THE ENZYME
REMARK 7 CYSTATHIONINE-“BETA”-SYNTASE [BATEMAN, A. (1997) TRENDS
REMARK 7 BIOCHEM. SCI. 22, 12-13]. THE CBS DIMER DOMAIN, FOUND IN
REMARK 7 IMPDH PROTEINS FROM ALL THREE KINGDOMS, IS COMPOSED OF TWO
REMARK 7 CBS MOTIFS RELATED BY APPROXIMATE TWOFOLD SYMMETRY (RMS
REMARK 7 DEVIATIONS BETWEEN ALPHA CARBON ATOMS: 2.7 ANGSTROMS).
REMARK 7 EACH CBS MOTIF HAS THE CHARACTERISTIC
REMARK 7 SHEET/HELIX/SHEET/SHEET/HELIX TOPOLOGY. THIS IS THE FIRST
REMARK 7 REPORTED COMPLETE STRUCTURE OF A CBS DIMER DOMAIN, A
REMARK 7 FOLDING MOTIF PROPOSED TO ACT AS A REGULATORY ELEMENT
REMARK 7 SINCE MUTATIONS LEAD TO THE HUMAN DISEASE HOMOCYSTINURIA.
REMARK 7 EACH IPMDH MONOMER CONTAINS IMP IN THE CATALYTIC SITE.
REMARK 7 THIS SUBSTRATE IS NOT COVALENTLY BOUND TO THE ACTIVE SITE
REMARK 7 CYS310 SUGGESTING THAT IMP DOES NOT FORM A COVALENT BOND
REMARK 7 IN THE ABSENCE OF NAD.
REMARK 100
REMARK 100 THIS ENTRY HAS BEEN PROCESSED BY RCSB ON MAR. 30, 1999.
REMARK 100 THE RCSB ID CODE IS RCSB000749.
REMARK 200
REMARK 200 EXPERIMENTAL DETAILS
REMARK 200 EXPERIMENT TYPE : X-RAY DIFFRACTION
REMARK 200 DATE OF DATA COLLECTION : NULL
REMARK 200 TEMPERATURE (KELVIN) : 110.0
REMARK 200 PH : 7.2
REMARK 200 NUMBER OF CRYSTALS USED : 1
REMARK 200
REMARK 200 SYNCHROTRON (Y/N) : Y
REMARK 200 RADIATION SOURCE : APS
REMARK 200 BEAMLINE : 19ID
REMARK 200 X-RAY GENERATOR MODEL : NULL
REMARK 200 MONOCHROMATIC OR LAUE (M/L) : M
REMARK 200 WAVELENGTH OR RANGE (A) : 0.9791, 1.0781
REMARK 200 MONOCHROMATOR : SI (111)
REMARK 200 OPTICS : MIRROR
REMARK 200
REMARK 200 DETECTOR TYPE : CCD
REMARK 200 DETECTOR MANUFACTURER : ANL (SBC1) 3X3 MOSAI
REMARK 200 INTENSITY-INTEGRATION SOFTWARE : DENZO (HKL2000)
REMARK 200 DATA SCALING SOFTWARE : SCALEPACK (HKL2000)
REMARK 200

```

TABLE 7-continued

REMARK	200	NUMBER OF UNIQUE REFLECTIONS	:	44921
REMARK	200	RESOLUTION RANGE HIGH	(A) :	1.9
REMARK	200	RESOLUTION RANGE LOW	(A) :	40.0
REMARK	200	REJECTION CRITERIA	(SIGMA(I)) :	0.0
REMARK	200	OVERALL		
REMARK	200	COMPLETENESS FOR RANGE	(%) :	96.5
REMARK	200	DATA REDUNDANCY	:	6.2
REMARK	200	R MERGE	(I) :	0.068
REMARK	200	R SYM	(I) :	NULL
REMARK	200	<I/SIGMA(I)> FOR THE DATA SET	:	6.0
REMARK	200	IN THE HIGHEST RESOLUTION SHELL		
REMARK	200	HIGHEST RESOLUTION SHELL, RANGE HIGH	(A) :	1.9
REMARK	200	HIGHEST RESOLUTION SHELL, RANGE LOW	(A) :	1.97
REMARK	200	COMPLETENESS FOR SHELL	(%) :	87.6
REMARK	200	DATA REDUNDANCY IN SHELL	:	3.0
REMARK	200	R MERGE FOR SHELL	(I) :	0.319
REMARK	200	R SYM FOR SHELL	(I) :	NULL
REMARK	200	<I/SIGMA(I)> FOR SHELL	:	2.5
REMARK	200	DIFFRACTION PROTOCOL: MAD		
REMARK	200	METHOD USED TO DETERMINE THE STRUCTURE: MAD		
REMARK	200	SOFTWARE USED: CNS, CCP4		
REMARK	200	STARTING MODEL: NULL		
REMARK	200	REMARK: NULL		
REMARK	280	CRYSTAL		
REMARK	280	SOLVENT CONTENT, VS	(%):	49.0
REMARK	280	MATTHEWS COEFFICIENT, VM (ANGSTROMS**3/DA):		NULL
REMARK	280	CRYSTALLIZATION CONDITIONS: 0.1 M MES (PH 7.2), 1.8 M		
REMARK	280	AMMONIUM SULFATE, 10 MM COCL2		
REMARK	290	CRYSTALLOGRAPHIC SYMMETRY		
REMARK	290	SYMMETRY OPERATORS FOR SPACE GROUP: I 4 2 2		
REMARK	290	SYMMOP	SYMMETRY	
REMARK	290	NNNMMM	OPERATOR	
REMARK	290	1555	X, Y, Z	
REMARK	290	2555	-X, -Y, Z	
REMARK	290	3555	-Y, X, Z	
REMARK	290	4555	Y, -X, Z	
REMARK	290	5555	-X, Y, -Z	
REMARK	290	6555	X, -Y, -Z	
REMARK	290	7555	Y, X, -Z	
REMARK	290	8555	-Y, -X, -Z	
REMARK	290	9555	1/2+X, 1/2+Y, 1/2+Z	
REMARK	290	10555	1/2-X, 1/2-Y, 1/2+Z	
REMARK	290	11555	1/2-Y, 1/2+X, 1/2+Z	
REMARK	290	12555	1/2+Y, 1/2-X, 1/2+Z	
REMARK	290	13555	1/2-X, 1/2+Y, 1/2-Z	
REMARK	290	14555	1/2+X, 1/2-Y, 1/2-Z	
REMARK	290	15555	1/2+Y, 1/2+X, 1/2-Z	
REMARK	290	16555	1/2-Y, 1/2-X, 1/2-Z	
REMARK	290	WHERE NNN -> OPERATOR NUMBER		
REMARK	290	MMM -> TRANSLATION VECTOR		
REMARK	290	CRYSTALLOGRAPHIC SYMMETRY TRANSFORMATIONS		
REMARK	290	THE FOLLOWING TRANSFORMATIONS OPERATE ON THE ATOM/HETATM		
REMARK	290	RECORDS IN THIS ENTRY TO PRODUCE CRYSTALLOGRAPHICALLY		
REMARK	290	RELATED MOLECULES.		
REMARK	290	SMTRY1	1	1.000000 0.000000 0.000000 0.000000
REMARK	290	SMTRY2	1	0.000000 1.000000 0.000000 0.000000
REMARK	290	SMTRY3	1	0.000000 0.000000 1.000000 0.000000
REMARK	290	SMTRY1	2	-1.000000 0.000000 0.000000 0.000000
REMARK	290	SMTRY2	2	0.000000 -1.000000 0.000000 0.000000
REMARK	290	SMTRY3	2	0.000000 0.000000 1.000000 0.000000
REMARK	290	SMTRY1	3	0.000000 -1.000000 0.000000 0.000000
REMARK	290	SMTRY2	3	1.000000 0.000000 0.000000 0.000000
REMARK	290	SMTRY3	3	0.000000 0.000000 1.000000 0.000000
REMARK	290	SMTRY1	4	0.000000 1.000000 0.000000 0.000000
REMARK	290	SMTRY2	4	-1.000000 0.000000 0.000000 0.000000
REMARK	290	SMTRY3	4	0.000000 0.000000 1.000000 0.000000
REMARK	290	SMTRY1	5	-1.000000 0.000000 0.000000 0.000000
REMARK	290	SMTRY2	5	0.000000 1.000000 0.000000 0.000000
REMARK	290	SMTRY3	5	0.000000 0.000000 -1.000000 0.000000

TABLE 7-continued

REMARK	290	SMTRY1	6	1.000000	0.000000	0.000000	0.000000
REMARK	290	SMTRY2	6	0.000000	-1.000000	0.000000	0.000000
REMARK	290	SMTRY3	6	0.000000	0.000000	-1.000000	0.000000
REMARK	290	SMTRY1	7	0.000000	1.000000	0.000000	0.000000
REMARK	290	SMTRY2	7	1.000000	0.000000	0.000000	0.000000
REMARK	290	SMTRY3	7	0.000000	0.000000	-1.000000	0.000000
REMARK	290	SMTRY1	8	0.000000	-1.000000	0.000000	0.000000
REMARK	290	SMTRY2	8	-1.000000	0.000000	0.000000	0.000000
REMARK	290	SMTRY3	8	0.000000	0.000000	-1.000000	0.000000
REMARK	290	SMTRY1	9	1.000000	0.000000	0.000000	75.74000
REMARK	290	SMTRY2	9	0.000000	1.000000	0.000000	75.74000
REMARK	290	SMTRY3	9	0.000000	0.000000	1.000000	50.84000
REMARK	290	SMTRY1	10	-1.000000	0.000000	0.000000	75.74000
REMARK	290	SMTRY2	10	0.000000	-1.000000	0.000000	75.74000
REMARK	290	SMTRY3	10	0.000000	0.000000	1.000000	50.84000
REMARK	290	SMTRY1	11	0.000000	-1.000000	0.000000	75.74000
REMARK	290	SMTRY2	11	1.000000	0.000000	0.000000	75.74000
REMARK	290	SMTRY3	11	0.000000	0.000000	1.000000	50.84000
REMARK	290	SMTRY1	12	0.000000	1.000000	0.000000	75.74000
REMARK	290	SMTRY2	12	-1.000000	0.000000	0.000000	75.74000
REMARK	290	SMTRY3	12	0.000000	0.000000	1.000000	50.84000
REMARK	290	SMTRY1	13	-1.000000	0.000000	0.000000	75.74000
REMARK	290	SMTRY2	13	0.000000	1.000000	0.000000	75.74000
REMARK	290	SMTRY3	13	0.000000	0.000000	-1.000000	50.84000
REMARK	290	SMTRY1	14	1.000000	0.000000	0.000000	75.74000
REMARK	290	SMTRY2	14	0.000000	-1.000000	0.000000	75.74000
REMARK	290	SMTRY3	14	0.000000	0.000000	-1.000000	50.84000
REMARK	290	SMTRY1	15	0.000000	1.000000	0.000000	75.74000
REMARK	290	SMTRY2	15	1.000000	0.000000	0.000000	75.74000
REMARK	290	SMTRY3	15	0.000000	0.000000	-1.000000	50.84000
REMARK	290	SMTRY1	16	0.000000	-1.000000	0.000000	75.74000
REMARK	290	SMTRY2	16	-1.000000	0.000000	0.000000	75.74000
REMARK	290	SMTRY3	16	0.000000	0.000000	-1.000000	50.84000
REMARK	290						
REMARK	290	REMARK: NULL					
REMARK	470						
REMARK	470	MISSING ATOM					
REMARK	470	THE FOLLOWING RESIDUES HAVE MISSING ATOMS (M = MODEL NUMBER;					
REMARK	470	RES = RESIDUE NAME; C = CHAIN IDENTIFIER; SSEQ = SEQUENCE NUMBER;					
REMARK	470	I = INSERTION CODE):					
REMARK	470	M RES CSSEQI ATOMS					
REMARK	470	LYS A 109 CG CD CE NZ					
REMARK	470	GLU A 114 CG CD OE1 OE2					
REMARK	470	ARG A 121 CG CD NE CZ NH1 NH2					
REMARK	470	ARG A 143 CG CD NE CZ NH1 NH2					
REMARK	470	LYS A 400 CG CD CE NZ					
REMARK	470	LYS A 401 CG CD CE NZ					
REMARK	470	ASN A 416 CG OD1 ND2					
REMARK	470	LYS A 417 CG CD CE NZ					
REMARK	470	LEU A 418 CG CD1 CD2					
REMARK	470	VAL A 492 CA C O CB CG1 CG2					
REMARK	500						
REMARK	500	GEOMETRY AND STEREOCHEMISTRY					
REMARK	500	SUBTOPIC: CLOSE CONTACTS					
REMARK	500						
REMARK	500	THE FOLLOWING ATOMS THAT ARE RELATED BY CRYSTALLOGRAPHIC					
REMARK	500	SYMMETRY ARE IN CLOSE CONTACT. AN ATOM LOCATED WITHIN 0.15					
REMARK	500	ANGSTROMS OF A SYMMETRY RELATED ATOM IS ASSUMED TO BE ON A					
REMARK	500	SPECIAL POSITION AND IS, THEREFORE, LISTED IN REMARK 375					
REMARK	500	INSTEAD OF REMARK 500. ATOMS WITH NON-BLANK ALTERNATE					
REMARK	500	LOCATION INDICATORS ARE NOT INCLUDED IN THE CALCULATIONS.					
REMARK	500						
REMARK	500	DISTANCE CUTOFF:					
REMARK	500	2.2 ANGSTROMS FOR CONTACTS NOT INVOLVING HYDROGEN ATOMS					
REMARK	500	1.6 ANGSTROMS FOR CONTACTS INVOLVING HYDROGEN ATOMS					
REMARK	500						
REMARK	500	ATM1 RES C SSEQI ATM2 RES C SSEQI SSYMOP DISTANCE					
REMARK	500	O HOH 866 O HOH 866 6565 2.10					
REMARK	500						
REMARK	500	GEOMETRY AND STEREOCHEMISTRY					
REMARK	500	SUBTOPIC: CLOSE CONTACTS IN SAME ASYMMETRIC UNIT					
REMARK	500						
REMARK	500	THE FOLLOWING ATOMS ARE IN CLOSE CONTACT.					
REMARK	500						
REMARK	500	ATM1 RES C SSEQI ATM2 RES C SSEQI					
REMARK	500	O HOH 676 O HOH 508 1.73					
REMARK	500	O HOH 641 OD1 ASN A 275 2.10					
REMARK	500						
REMARK	500	GEOMETRY AND STEREOCHEMISTRY					

TABLE 7-continued

REMARK	500	SUBTOPIC: COVALENT BOND ANGLES					
REMARK	500						
REMARK	500	THE STEREOCHEMICAL PARAMETERS OF THE FOLLOWING RESIDUES					
REMARK	500	HAVE VALUES WHICH DEVIATE FROM EXPECTED VALUES BY MORE					
REMARK	500	THAN 4° RMSD (M = MODEL NUMBER; RES = RESIDUE NAME; C = CHAIN					
REMARK	500	IDENTIFIER; SSEQ = SEQUENCE NUMBER; I = INSERTION CODE).					
REMARK	500						
REMARK	500	STANDARD TABLE:					
REMARK	500	FORMAT: (10X, I3, 1X, A3, 1X, A1, I4, A1, 3 (1X, A4, 2X), 12X, F5.1)					
REMARK	500						
REMARK	500	EXPECTED VALUES: ENGH AND HUBER, 1991					
REMARK	500						
REMARK	500	M RES	CSSEQI	ATM1	ATM2	ATM3	
REMARK	500	PHE	A	8 N	- CA	- C	ANGL. DEV. = -6.3 DEGREES
REMARK	500	THR	A	14 N	- CA	- C	ANGL. DEV. = -7.3 DEGREES
REMARK	500	ASP	A	16 N	- CA	- C	ANGL. DEV. = 5.5 DEGREES
REMARK	500	VAL	A	18 N	- CA	- C	ANGL. DEV. = 6.1 DEGREES
REMARK	500	PRO	A	22 CB	- CG	- CD	ANGL. DEV. = -6.5 DEGREES
REMARK	500	PRO	A	29 CB	- CG	- CD	ANGL. DEV. = -7.0 DEGREES
REMARK	500	LEU	A	42 N	- CA	- C	ANGL. DEV. = 6.8 DEGREES
REMARK	500	ILE	A	46 N	- CA	- C	ANGL. DEV. = -6.8 DEGREES
REMARK	500	PRO	A	47 CB	- CG	- CD	ANGL. DEV. = -6.7 DEGREES
REMARK	500	THR	A	57 N	- CA	- C	ANGL. DEV. = 10.1 DEGREES
REMARK	500	GLY	A	58 N	- CA	- C	ANGL. DEV. = -10.6 DEGREES
REMARK	500	GLU	A	86 N	- CA	- C	ANGL. DEV. = -5.8 DEGREES
REMARK	500	ASN	A	95 N	- CA	- C	ANGL. DEV. = -6.1 DEGREES
REMARK	500	ILE	A	99 N	- CA	- C	ANGL. DEV. = -6.4 DEGREES
REMARK	500	PRO	A	101 CB	- CG	- CD	ANGL. DEV. = -6.8 DEGREES
REMARK	500	PHE	A	102 N	- CA	- C	ANGL. DEV. = -7.3 DEGREES
REMARK	500	PRO	A	106 CB	- CG	- CD	ANGL. DEV. = -7.2 DEGREES
REMARK	500	LEU	A	116 CA	- CB	- CG	ANGL. DEV. = 6.4 DEGREES
REMARK	500	PRO	A	126 CB	- CG	- CD	ANGL. DEV. = -6.9 DEGREES
REMARK	500	LYS	A	135 N	- CA	- C	ANGL. DEV. = -6.0 DEGREES
REMARK	500	PRO	A	154 CB	- CG	- CD	ANGL. DEV. = -7.5 DEGREES
REMARK	500	HIS	A	158 N	- CA	- C	ANGL. DEV. = -7.0 DEGREES
REMARK	500	GLU	A	162 N	- CA	- C	ANGL. DEV. = -5.6 DEGREES
REMARK	500	HIS	A	163 N	- CA	- C	ANGL. DEV. = -5.8 DEGREES
REMARK	500	THR	A	171 N	- CA	- C	ANGL. DEV. = -6.1 DEGREES
REMARK	500	PRO	A	189 CB	- CG	- CD	ANGL. DEV. = -7.2 DEGREES
REMARK	500	PRO	A	213 N	- CA	- C	ANGL. DEV. = 6.3 DEGREES
REMARK	500	PRO	A	213 CB	- CG	- CD	ANGL. DEV. = -7.9 DEGREES
REMARK	500	ALA	A	216 N	- CA	- C	ANGL. DEV. = -6.8 DEGREES
REMARK	500	VAL	A	229 N	- CA	- C	ANGL. DEV. = -7.0 DEGREES
REMARK	500	ILE	A	252 N	- CA	- C	ANGL. DEV. = -8.2 DEGREES
REMARK	500	PRO	A	274 N	- CA	- C	ANGL. DEV. = 6.7 DEGREES
REMARK	500	PRO	A	274 CB	- CG	- CD	ANGL. DEV. = -7.9 DEGREES
REMARK	500	ILE	A	279 N	- CA	- C	ANGL. DEV. = -9.5 DEGREES
REMARK	500	ALA	A	280 N	- CA	- C	ANGL. DEV. = 7.8 DEGREES
REMARK	500	GLY	A	281 N	- CA	- C	ANGL. DEV. = 6.4 DEGREES
REMARK	500	GLY	A	281 C	- N	- CA	ANGL. DEV. = 6.2 DEGREES
REMARK	500	ASN	A	282 N	- CA	- C	ANGL. DEV. = 6.9 DEGREES
REMARK	500	ILE	A	283 N	- CA	- C	ANGL. DEV. = -6.3 DEGREES
REMARK	500	GLY	A	305 N	- CA	- C	ANGL. DEV. = 9.1 DEGREES
REMARK	500	PRO	A	306 N	- CA	- C	ANGL. DEV. = 6.5 DEGREES
REMARK	500	PRO	A	306 CB	- CG	- CD	ANGL. DEV. = -6.4 DEGREES
REMARK	500	PRO	A	321 CB	- CG	- CD	ANGL. DEV. = -7.5 DEGREES
REMARK	500	GLN	A	322 N	- CA	- C	ANGL. DEV. = 9.4 DEGREES
REMARK	500	THR	A	339 N	- CA	- C	ANGL. DEV. = 8.8 DEGREES
REMARK	500	ILE	A	341 N	- CA	- C	ANGL. DEV. = -5.8 DEGREES
REMARK	500	ALA	A	342 N	- CA	- C	ANGL. DEV. = -6.2 DEGREES
REMARK	500	ASP	A	343 N	- CA	- C	ANGL. DEV. = 5.8 DEGREES
REMARK	500	GLY	A	344 N	- CA	- C	ANGL. DEV. = 9.5 DEGREES
REMARK	500	ALA	A	370 N	- CA	- C	ANGL. DEV. = 11.1 DEGREES
REMARK	500	GLU	A	374 N	- CA	- C	ANGL. DEV. = 6.6 DEGREES
REMARK	500	PRO	A	376 CB	- CG	- CD	ANGL. DEV. = -7.0 DEGREES
REMARK	500	LYS	A	388 N	- CA	- C	ANGL. DEV. = -5.8 DEGREES
REMARK	500	TYR	A	390 N	- CA	- C	ANGL. DEV. = -7.0 DEGREES
REMARK	500	PRO	A	420 CB	- CG	- CD	ANGL. DEV. = -7.1 DEGREES
REMARK	500	GLU	A	461 N	- CA	- C	ANGL. DEV. = 7.6 DEGREES
REMARK	500	ASN	A	462 N	- CA	- C	ANGL. DEV. = 8.8 DEGREES
REMARK	500	VAL	A	466 N	- CA	- C	ANGL. DEV. = -9.7 DEGREES
REMARK	500	PRO	A	478 N	- CA	- C	ANGL. DEV. = -5.6 DEGREES
REMARK	500	PRO	A	478 CB	- CG	- CD	ANGL. DEV. = -7.4 DEGREES
REMARK	500	PRO	A	488 CB	- CG	- CD	ANGL. DEV. = -7.9 DEGREES
REMARK	500						
REMARK	500	GEOMETRY AND STEREOCHEMISTRY					
REMARK	500	SUBTOPIC: TORSION ANGLES					
REMARK	500						
REMARK	500	TORSION ANGLES OUTSIDE THE EXPECTED RAMACHANDRAN REGIONS:					

TABLE 7-continued

```

REMARK 500 (M = MODEL NUMBER; RES = RESIDUE NAME; C = CHAIN IDENTIFIER;
REMARK 500 SSEQ = SEQUENCE NUMBER; I = INSERTION CODE).
REMARK 500 STANDARD TABLE:
REMARK 500 FORMAT: (10X, I3, 1X, A3, 1X, A1, I4, A1, 4X, F7.2, 3X, F7.2)
REMARK 500
REMARK 500 M RES CSSEQI PSI PHI
REMARK 500
REMARK 500 SER A 491 55.58 166.71
REMARK 525
REMARK 525 SOLVENT
REMARK 525 THE FOLLOWING SOLVENT MOLECULES LIE FARTHER THAN EXPECTED
REMARK 525 FROM THE PROTEIN OR NUCLEIC ACID MOLECULE AND MAY BE
REMARK 525 ASSOCIATED WITH A SYMMETRY RELATED MOLECULE (M = MODEL
REMARK 525 NUMBER; RES = RESIDUE NAME; C = CHAIN IDENTIFIER; SSEQ = SEQUENCE
REMARK 525 NUMBER; I = INSERTION CODE);
REMARK 525
REMARK 525 M RES CSSEQI
REMARK 525 0 HOH 639 DISTANCE = 8.02 ANGSTROMS
REMARK 525 0 HOH 730 DISTANCE = 6.58 ANGSTROMS
REMARK 525 0 HOH 861 DISTANCE = 5.23 ANGSTROMS
REMARK 525 0 HOH 971 DISTANCE = 5.97 ANGSTROMS
REMARK 525 0 HOH 983 DISTANCE = 6.42 ANGSTROMS
REMARK 525 0 HOH 999 DISTANCE = 6.03 ANGSTROMS
REMARK 525 0 HOH 1021 DISTANCE = 5.20 ANGSTROMS
REMARK 525 0 HOH 1079 DISTANCE = 5.11 ANGSTROMS
REMARK 525 0 HOH 1095 DISTANCE = 5.09 ANGSTROMS
REMARK 525 0 HOH 1136 DISTANCE = 6.40 ANGSTROMS
REMARK 525 0 HOH 1167 DISTANCE = 6.38 ANGSTROMS
REMARK 525 0 HOH 1173 DISTANCE = 5.10 ANGSTROMS
REMARK 525 0 HOH 1181 DISTANCE = 6.76 ANGSTROMS
REMARK 525 0 HOH 1190 DISTANCE = 5.68 ANGSTROMS
REMARK 525 0 HOH 1207 DISTANCE = 8.81 ANGSTROMS
REMARK 525 0 HOH 1216 DISTANCE = 7.22 ANGSTROMS
REMARK 525 0 HOH 1227 DISTANCE = 6.43 ANGSTROMS
REMARK 525 0 HOH 1282 DISTANCE = 7.10 ANGSTROMS
REMARK 525 0 HOH 1302 DISTANCE = 6.33 ANGSTROMS
REMARK 525 0 HOH 1309 DISTANCE = 5.01 ANGSTROMS
REMARK 525 0 HOH 1314 DISTANCE = 5.92 ANGSTROMS
REMARK 525 0 HOH 1316 DISTANCE = 5.40 ANGSTROMS
REMARK 525 0 HOH 1328 DISTANCE = 5.08 ANGSTROMS
REMARK 525 0 HOH 1350 DISTANCE = 6.15 ANGSTROMS
REMARK 525 0 HOH 1351 DISTANCE = 6.96 ANGSTROMS
REMARK 525 0 HOH 1352 DISTANCE = 7.28 ANGSTROMS
REMARK 800
REMARK 800 SITE
REMARK 800 SITE_IDENTIFIER: ASC
REMARK 800 SITE_DESCRIPTION:
REMARK 800 ACTIVE SITE CYSTEINE
REMARK 800
DBREF 1ZFJ A 2 491 SWS P50099 IMDH_STRPY 2 491
SEQADV 1ZFJ TYR A 387 SWS 1ZFJ_A PHE 387 CONFLICT
SEQADV 1ZFJ SWS 1ZFJ_A GLY 402 GAP IN THE PDB ENTRY
SEQADV 1ZFJ SWS 1ZFJ_A SER 403 GAP IN THE PDB ENTRY
SEQADV 1ZFJ SWS 1ZFJ_A SER 404 GAP IN THE PDB ENTRY
SEQADV 1ZFJ SWS 1ZFJ_A ASN 405 GAP IN THE PDB ENTRY
SEQADV 1ZFJ SWS 1ZFJ_A ARG 406 GAP IN THE PDB ENTRY
SEQADV 1ZFJ SWS 1ZFJ_A TYR 407 GAP IN THE PDB ENTRY
SEQADV 1ZFJ SWS 1ZFJ_A PHE 408 GAP IN THE PDB ENTRY
SEQADV 1ZFJ SWS 1ZFJ_A GLN 409 GAP IN THE PDB ENTRY
SEQADV 1ZFJ SWS 1ZFJ_A GLY 410 GAP IN THE PDB ENTRY
SEQADV 1ZFJ SWS 1ZFJ_A SER 411 GAP IN THE PDB ENTRY
SEQADV 1ZFJ SWS 1ZFJ_A VAL 412 GAP IN THE PDB ENTRY
SEQADV 1ZFJ SWS 1ZFJ_A ASN 413 GAP IN THE PDB ENTRY
SEQADV 1ZFJ SWS 1ZFJ_A GLU 414 GAP IN THE PDB ENTRY
SEQADV 1ZFJ SWS 1ZFJ_A ALA 415 GAP IN THE PDB ENTRY
SEQADV 1ZFJ MSE A 53 SWS 1ZFJ_A MET 53 ENGINEERED
SEQADV 1ZFJ MSE A 61 SWS 1ZFJ_A MET 61 ENGINEERED
SEQADV 1ZFJ MSE A 78 SWS 1ZFJ_A MET 78 ENGINEERED
SEQADV 1ZFJ MSE A 117 SWS 1ZFJ_A MET 117 ENGINEERED
SEQADV 1ZFJ MSE A 145 SWS 1ZFJ_A MET 145 ENGINEERED
SEQADV 1ZFJ MSE A 159 SWS 1ZFJ_A MET 159 ENGINEERED
SEQADV 1ZFJ MSE A 364 SWS 1ZFJ_A MET 364 ENGINEERED
SEQADV 1ZFJ MSE A 368 SWS 1ZFJ_A MET 368 ENGINEERED
SEQADV 1ZFJ MSE A 393 SWS 1ZFJ_A MET 393 ENGINEERED
SEQADV 1ZFJ MSE A 399 SWS 1ZFJ_A MET 399 ENGINEERED
SEQADV 1ZFJ MSE A 440 SWS 1ZFJ_A MET 440 ENGINEERED
SEQADV 1ZFJ MSE A 448 SWS 1ZFJ_A MET 448 ENGINEERED
SEQADV 1ZFJ MSE A 468 SWS 1ZFJ_A MET 468 ENGINEERED
SEQRES 1 A 477 SER ASN TRP ASP THR LYS PHE LEU LYS LYS GLY TYR THR

```

TABLE 7-continued

SEQRES	2	A	477	PHE	ASP	ASP	VAL	LEU	LEU	ILE	PRO	ALA	GLU	SER	HIS	VAL
SEQRES	3	A	477	LEU	PRO	ASN	GLU	VAL	ASP	LEU	LYS	THR	LYS	LEU	ALA	ASP
SEQRES	4	A	477	ASN	LEU	THR	LEU	ASN	ILE	PRO	ILE	ILE	THR	ALA	ALA	MSE
SEQRES	5	A	477	ASP	THR	VAL	THR	GLY	SER	LYS	MSE	ALA	ILE	ALA	ILE	ALA
SEQRES	6	A	477	ARG	ALA	GLY	GLY	LEU	GLY	VAL	ILE	HIS	LYS	ASN	MSE	SER
SEQRES	7	A	477	ILE	THR	GLU	GLN	ALA	GLU	GLU	VAL	ARG	LYS	VAL	LYS	ARG
SEQRES	8	A	477	SER	GLU	ASN	GLY	VAL	ILE	ILE	ASP	PRO	PHE	PHE	LEU	THR
SEQRES	9	A	477	PRO	GLU	HIS	LYS	VAL	SER	GLU	ALA	GLU	GLU	LEU	MSE	GLN
SEQRES	10	A	477	ARG	TYR	ARG	ILE	SER	GLY	VAL	PRO	ILE	VAL	GLU	THR	LEU
SEQRES	11	A	477	ALA	ASN	ARG	LYS	LEU	VAL	GLY	ILE	ILE	THR	ASN	ARG	ASP
SEQRES	12	A	477	MSE	ARG	PHE	ILE	SER	ASP	TYR	ASN	ALA	PRO	ILE	SER	GLU
SEQRES	13	A	477	HIS	MSE	THR	SER	GLU	HIS	LEU	VAL	THR	ALA	ALA	VAL	GLY
SEQRES	14	A	477	THR	ASP	LEU	GLU	THR	ALA	GLU	ARG	ILE	LEU	HIS	GLU	HIS
SEQRES	15	A	477	ARG	ILE	GLU	LYS	LEU	PRO	LEU	VAL	ASP	ASN	SER	GLY	ARG
SEQRES	16	A	477	LEU	SER	GLY	LEU	ILE	THR	ILE	LYS	ASP	ILE	GLU	LYS	VAL
SEQRES	17	A	477	ILE	GLU	PHE	PRO	HIS	ALA	ALA	LYS	ASP	GLU	PHE	GLY	ARG
SEQRES	18	A	477	LEU	LEU	VAL	ALA	ALA	ALA	VAL	GLY	VAL	THR	SER	ASP	THR
SEQRES	19	A	477	PHE	GLU	ARG	ALA	GLU	ALA	LEU	PHE	GLU	ALA	GLY	ALA	ASP
SEQRES	20	A	477	ALA	ILE	VAL	ILE	ASP	THR	ALA	HIS	GLY	HIS	SER	ALA	GLY
SEQRES	21	A	477	VAL	LEU	ARG	LYS	ILE	ALA	GLU	ILE	ARG	ALA	HIS	PHE	PRO
SEQRES	22	A	477	ASN	ARG	THR	LEU	ILE	ALA	GLY	ASN	ILE	ALA	THR	ALA	GLU
SEQRES	23	A	477	GLY	ALA	ARG	ALA	LEU	TYR	ASP	ALA	GLY	VAL	ASP	VAL	VAL
SEQRES	24	A	477	LYS	VAL	GLY	ILE	GLY	PRO	GLY	SER	ILE	CYS	THR	THR	ARG
SEQRES	25	A	477	VAL	VAL	ALA	GLY	VAL	GLY	VAL	PRO	GLN	VAL	THR	ALA	ILE
SEQRES	26	A	477	TYR	ASP	ALA	ALA	ALA	VAL	ALA	ARG	GLU	TYR	GLY	LYS	THR
SEQRES	27	A	477	ILE	ILE	ALA	ASP	GLY	GLY	ILE	LYS	TYR	SER	GLY	ASP	ILE
SEQRES	28	A	477	VAL	LYS	ALA	LEU	ALA	ALA	GLY	GLY	ASN	ALA	VAL	MSE	LEU
SEQRES	29	A	477	GLY	SER	MSE	PHE	ALA	GLY	THR	ASP	GLU	ALA	PRO	GLY	GLU
SEQRES	30	A	477	THR	GLU	ILE	TYR	GLN	GLY	ARG	LYS	TYR	LYS	THR	TYR	ARG
SEQRES	31	A	477	GLY	MSE	GLY	SER	ILE	ALA	ALA	MSE	LYS	LYS	ASN	LYS	LEU
SEQRES	32	A	477	VAL	PRO	GLU	GLY	ILE	GLU	GLY	ARG	VAL	ALA	TYR	LYS	GLY
SEQRES	33	A	477	ALA	ALA	SER	ASP	ILE	VAL	PHE	GLN	MSE	LEU	GLY	GLY	ILE
SEQRES	34	A	477	ARG	SER	GLY	MSE	GLY	TYR	VAL	GLY	ALA	GLY	ASP	ILE	GLN
SEQRES	35	A	477	GLU	LEU	HIS	GLU	ASN	ALA	GLN	PHE	VAL	GLU	MSE	SER	GLY
SEQRES	36	A	477	ALA	GLY	LEU	ILE	GLU	SER	HIS	PRO	HIS	ASP	VAL	GLN	ILE
SEQRES	37	A	477	THR	ASN	GLU	ALA	PRO	ASN	TYR	SER	VAL	(SEQ ID NO: 23)			
MODRES	1ZFJ	MSE	A			53	MET	SELENOMETHIONINE								
MODRES	1ZFJ	MSE	A			61	MET	SELENOMETHIONINE								
MODRES	1ZFJ	MSE	A			78	MET	SELENOMETHIONINE								
MODRES	1ZFJ	MSE	A			117	MET	SELENOMETHIONINE								
MODRES	1ZFJ	MSE	A			145	MET	SELENOMETHIONINE								
MODRES	1ZFJ	MSE	A			159	MET	SELENOMETHIONINE								
MODRES	1ZFJ	MSE	A			364	MET	SELENOMETHIONINE								
MODRES	1ZFJ	MSE	A			368	MET	SELENOMETHIONINE								
MODRES	1ZFJ	MSE	A			393	MET	SELENOMETHIONINE								
MODRES	1ZFJ	MSE	A			399	MET	SELENOMETHIONINE								
MODRES	1ZFJ	MSE	A			440	MET	SELENOMETHIONINE								
MODRES	1ZFJ	MSE	A			448	MET	SELENOMETHIONINE								
MODRES	1ZFJ	MSE	A			468	MET	SELENOMETHIONINE								
HET	MSE	A				53		8								
HET	MSE	A				61		8								
HET	MSE	A				78		8								
HET	MSE	A				117		8								
HET	MSE	A				145		8								
HET	MSE	A				159		8								
HET	MSE	A				364		8								
HET	MSE	A				368		8								
HET	MSE	A				393		8								
HET	MSE	A				399		8								
HET	MSE	A				440		8								
HET	MSE	A				448		8								
HET	MSE	A				468		8								
HET	IMP					500		23								
HETNAM	MSE						SELENOMETHIONINE									
HETNAM	IMP						INOSINE-5'-MONOPHOSPHATE									
FORMUL	1	MSE					13(C5 H11 N1 O2 SE1)									
FORMUL	2	IMP					C10 H13 N4 O8 P1									
FORUUL	3	HOH					*499(H2 O1)									
HELIX	1		1	ASN	A		3	THR	A	6	5					4
HELIX	2		2	PHE	A		15	ASP	A	17	5					3
HELIX	3		3	PRO	A		29	GLU	A	31	5					3
HELIX	4		4	SER	A		59	ARG	A	67	5					9
HELIX	5		5	ILE	A		80	SER	A	93	1					14
HELIX	6		6	VAL	A		110	ARG	A	119	1					10
HELIX	7		7	ASN	A		142	PHE	A	147	5					6
HELIX	8		8	LEU	A		173	GLU	A	182	1					10
HELIX	9		9	ILE	A		203	GLU	A	211	1					9
HELIX	10		10	THR	A		235	ALA	A	245	1					11
HELIX	11		11	ALA	A		260	HIS	A	272	1					13

TABLE 7-continued

ATOM	49	CG	LYS	A	7	77.415	57.120	37.712	1.00	23.59	C
ATOM	50	CD	LYS	A	7	78.423	56.039	37.368	1.00	23.54	C
ATOM	51	CE	LYS	A	7	78.212	54.773	38.186	1.00	22.78	C
ATOM	52	NZ	LYS	A	7	79.139	53.678	37.755	1.00	22.29	N
ATOM	53	N	PHE	A	8	78.603	60.514	39.102	1.00	29.06	N
ATOM	54	CA	PHE	A	8	78.860	61.781	38.420	1.00	30.23	C
ATOM	55	C	PHE	A	8	79.805	62.533	39.339	1.00	31.17	C
ATOM	56	O	PHE	A	8	79.392	63.206	40.278	1.00	32.04	O
ATOM	57	CB	PHE	A	8	77.542	62.513	38.205	1.00	29.85	C
ATOM	58	CG	PHE	A	8	76.578	61.731	37.370	1.00	30.55	C
ATOM	59	CD1	PHE	A	8	76.775	61.602	36.002	1.00	29.92	C
ATOM	60	CD2	PHE	A	8	75.544	61.019	37.963	1.00	30.12	C
ATOM	61	CE1	PHE	A	8	75.958	60.770	35.241	1.00	30.48	C
ATOM	62	CE2	PHE	A	8	74.730	60.193	37.209	1.00	28.97	C
ATOM	63	CZ	PHE	A	8	74.937	60.065	35.850	1.00	29.91	C
ATOM	64	N	LEU	A	9	81.090	62.394	39.049	1.00	32.70	N
ATOM	65	CA	LEU	A	9	82.135	62.968	39.870	1.00	34.57	C
ATOM	66	C	LEU	A	9	82.222	64.485	39.903	1.00	36.07	C
ATOM	67	O	LEU	A	9	82.161	65.092	40.978	1.00	37.88	O
ATOM	68	CB	LEU	A	9	83.482	62.380	39.451	1.00	33.71	C
ATOM	69	CG	LEU	A	9	84.593	62.591	40.469	1.00	32.58	C
ATOM	70	CD1	LEU	A	9	84.139	62.012	41.789	1.00	32.56	C
ATOM	71	CD2	LEU	A	9	85.872	61.928	40.002	1.00	31.98	C
ATOM	72	N	LYS	A	10	82.377	65.104	38.740	1.00	35.80	N
ATOM	73	CA	LYS	A	10	82.482	66.554	38.696	1.00	35.27	C
ATOM	74	C	LYS	A	10	82.560	67.096	37.284	1.00	34.79	C
ATOM	75	O	LYS	A	10	82.440	66.341	36.321	1.00	35.02	O
ATOM	76	CB	LYS	A	10	83.699	67.008	39.514	1.00	35.85	C
ATOM	77	CG	LYS	A	10	84.974	66.179	39.333	1.00	33.88	C
ATOM	78	CD	LYS	A	10	85.554	66.275	37.947	1.00	33.98	C
ATOM	79	CE	LYS	A	10	86.901	65.574	37.880	1.00	35.39	C
ATOM	80	NZ	LYS	A	10	87.937	66.213	38.746	1.00	35.48	N
ATOM	81	N	LYS	A	11	82.742	68.407	37.167	1.00	33.79	N
ATOM	82	CA	LYS	A	11	82.841	69.046	35.861	1.00	33.06	C
ATOM	83	C	LYS	A	11	84.280	69.274	35.431	1.00	30.80	C
ATOM	84	O	LYS	A	11	85.159	69.516	36.259	1.00	30.97	O
ATOM	85	CB	LYS	A	11	82.072	70.365	35.858	1.00	35.00	C
ATOM	86	CG	LYS	A	11	80.568	70.163	35.851	1.00	40.89	C
ATOM	87	CD	LYS	A	11	79.802	71.475	35.945	1.00	44.76	C
ATOM	88	CE	LYS	A	11	80.018	72.131	37.301	1.00	47.54	C
ATOM	89	NZ	LYS	A	11	79.596	71.236	38.419	1.00	48.72	N
ATOM	90	N	GLY	A	12	84.511	69.168	34.126	1.00	29.21	N
ATOM	91	CA	GLY	A	12	85.837	69.370	33.576	1.00	26.68	C
ATOM	92	C	GLY	A	12	85.824	70.536	32.604	1.00	26.32	C
ATOM	93	O	GLY	A	12	84.807	70.798	31.952	1.00	25.14	O
ATOM	94	N	TYR	A	13	86.949	71.241	32.522	1.00	25.87	N
ATOM	95	CA	TYR	A	13	87.095	72.389	31.633	1.00	27.06	C
ATOM	96	C	TYR	A	13	88.044	72.084	30.500	1.00	26.35	C
ATOM	97	O	TYR	A	13	89.042	71.397	30.690	1.00	25.99	O
ATOM	98	CB	TYR	A	13	87.659	73.604	32.376	1.00	29.47	C
ATOM	99	CG	TYR	A	13	86.747	74.148	33.430	1.00	34.86	C
ATOM	100	CD1	TYR	A	13	85.471	74.600	33.098	1.00	36.83	C
ATOM	101	CD2	TYR	A	13	87.147	74.206	34.763	1.00	37.11	C
ATOM	102	CE1	TYR	A	13	84.612	75.093	34.062	1.00	39.35	C
ATOM	103	CE2	TYR	A	13	86.294	74.700	35.739	1.00	40.44	C
ATOM	104	CZ	TYR	A	13	85.027	75.140	35.379	1.00	41.53	c
ATOM	105	OH	TYR	A	13	84.161	75.613	36.336	1.00	45.89	O
ATOM	106	N	THR	A	14	87.727	72.606	29.322	1.00	25.75	N
ATOM	107	CA	THR	A	14	88.585	72.448	28.159	1.00	25.34	C
ATOM	108	C	THR	A	14	89.024	73.877	27.830	1.00	23.61	C
ATOM	109	O	THR	A	14	88.469	74.832	28.367	1.00	22.92	O
ATOM	110	CB	THR	A	14	87.817	71.829	26.970	1.00	26.77	C
ATOM	111	OG1	THR	A	14	88.700	71.699	25.846	1.00	31.58	O
ATOM	112	CG2	THR	A	14	86.635	72.702	26.583	1.00	27.27	C
ATOM	113	N	PHE	A	15	90.011	74.032	26.957	1.00	22.10	N
ATOM	114	CA	PHE	A	15	90.509	75.353	26.613	1.00	20.64	C
ATOM	115	C	PHE	A	15	89.435	76.391	26.278	1.00	20.42	C
ATOM	116	O	PHE	A	15	89.579	77.555	26.641	1.00	20.85	O
ATOM	117	CB	PHE	A	15	91.504	75.238	25.460	1.00	20.90	C
ATOM	118	CG	PHE	A	15	92.685	74.365	25.770	1.00	21.02	C
ATOM	119	CD1	PHE	A	15	93.568	74.699	26.790	1.00	20.82	C
ATOM	120	CD2	PHE	A	15	92.897	73.189	25.070	1.00	20.78	C
ATOM	121	CE1	PHE	A	15	94.636	73.871	27.102	1.00	20.57	C
ATOM	122	CE2	PHE	A	15	93.967	72.356	25.381	1.00	20.90	C
ATOM	123	CZ	PHE	A	15	94.832	72.699	26.396	1.00	19.69	C
ATOM	124	N	ASP	A	16	88.362	75.987	25.601	1.00	20.30	N
ATOM	125	CA	ASP	A	16	87.318	76.936	25.230	1.00	21.26	C
ATOM	126	C	ASP	A	16	86.312	77.314	26.320	1.00	20.86	C
ATOM	127	O	ASP	A	16	85.364	78.050	26.061	1.00	20.85	O

TABLE 7-continued

ATOM	128	CB	ASP	A	16	86.564	76.457	23.983	1.00	23.23	C
ATOM	129	CG	ASP	A	16	87.418	76.509	22.721	1.00	28.01	C
ATOM	130	OD1	ASP	A	16	88.319	77.374	22.636	1.00	29.29	O
ATOM	131	OD2	ASP	A	16	87.167	75.713	21.789	1.00	31.34	O
ATOM	132	N	ASP	A	17	86.511	76.824	27.538	1.00	21.11	N
ATOM	133	CA	ASP	A	17	85.609	77.165	28.645	1.00	20.51	C
ATOM	134	C	ASP	A	17	86.192	78.287	29.487	1.00	19.73	C
ATOM	135	O	ASP	A	17	85.475	78.926	30.244	1.00	20.34	O
ATOM	136	CB	ASP	A	17	85.376	75.971	29.581	1.00	20.06	C
ATOM	137	CG	ASP	A	17	84.651	74.827	28.913	1.00	21.90	C
ATOM	138	OD1	ASP	A	17	83.571	75.067	28.330	1.00	21.40	O
ATOM	139	OD2	ASP	A	17	85.151	73.680	28.985	1.00	21.34	O
ATOM	140	N	VAL	A	18	87.491	78.530	29.343	1.00	19.47	N
ATOM	141	CA	VAL	A	18	88.180	79.532	30.149	1.00	19.26	C
ATOM	142	C	VAL	A	18	89.054	80.548	29.410	1.00	20.62	C
ATOM	143	O	VAL	A	18	89.468	80.344	28.267	1.00	20.73	O
ATOM	144	CB	VAL	A	18	89.076	78.833	31.199	1.00	18.24	C
ATOM	145	CG1	VAL	A	18	88.244	77.912	32.060	1.00	17.13	C
ATOM	146	CG2	VAL	A	18	90.169	78.038	30.505	1.00	17.00	C
ATOM	147	N	LEU	A	19	89.335	81.642	30.106	1.00	20.27	N
ATOM	148	CA	LEU	A	19	90.186	82.723	29.627	1.00	21.23	C
ATOM	149	C	LEU	A	19	91.101	83.118	30.785	1.00	21.23	C
ATOM	150	O	LEU	A	19	90.700	83.040	31.946	1.00	21.35	O
ATOM	151	CB	LEU	A	19	89.347	83.945	29.245	1.00	20.79	C
ATOM	152	CG	LEU	A	19	88.497	83.867	27.991	1.00	20.91	C
ATOM	153	CD1	LEU	A	19	87.558	85.052	27.924	1.00	19.17	C
ATOM	154	CD2	LEU	A	19	89.417	83.812	26.798	1.00	19.74	C
ATOM	155	N	LEU	A	20	92.324	83.537	30.484	1.00	20.61	N
ATOM	156	CA	LEU	A	20	93.222	83.979	31.541	1.00	21.37	C
ATOM	157	C	LEU	A	20	92.857	85.421	31.868	1.00	22.07	C
ATOM	158	O	LEU	A	20	92.623	86.234	30.972	1.00	22.23	O
ATOM	159	CB	LEU	A	20	94.676	83.894	31.087	1.00	20.78	C
ATOM	160	CG	LEU	A	20	95.210	82.474	30.972	1.00	21.20	C
ATOM	161	CD1	LEU	A	20	96.567	82.488	30.305	1.00	22.29	C
ATOM	162	CD2	LEU	A	20	95.273	81.857	32.355	1.00	20.57	C
ATOM	163	N	ILE	A	21	92.796	85.734	33.154	1.00	22.61	N
ATOM	164	CA	ILE	A	21	92.442	87.075	33.591	1.00	21.81	C
ATOM	165	C	ILE	A	21	93.657	87.998	33.597	1.00	23.02	C
ATOM	166	O	ILE	A	21	94.720	87.649	34.121	1.00	24.26	O
ATOM	167	CB	ILE	A	21	91.838	87.041	35.010	1.00	21.50	C
ATOM	168	CG1	ILE	A	21	90.667	86.055	35.059	1.00	20.85	C
ATOM	169	CG2	ILE	A	21	91.363	88.434	35.403	1.00	22.33	C
ATOM	170	CD1	ILE	A	21	90.045	85.907	36.432	1.00	19.20	C
ATOM	171	N	PRO	A	22	93.522	89.195	33.010	1.00	23.71	N
ATOM	172	CA	PRO	A	22	94.637	90.141	32.979	1.00	23.92	C
ATOM	173	C	PRO	A	22	95.029	90.494	34.416	1.00	24.84	C
ATOM	174	O	PRO	A	22	94.176	90.501	35.300	1.00	26.16	O
ATOM	175	CB	PRO	A	22	94.033	91.330	32.240	1.00	23.95	C
ATOM	176	CG	PRO	A	22	92.999	90.678	31.355	1.00	24.02	C
ATOM	177	CD	PRO	A	22	92.346	89.784	32.351	1.00	23.20	C
ATOM	178	N	ALA	A	23	96.308	90.784	34.652	1.00	25.54	N
ATOM	179	CA	ALA	A	23	96.780	91.131	35.995	1.00	25.69	C
ATOM	180	C	ALA	A	23	97.898	92.164	35.919	1.00	26.22	C
ATOM	181	O	ALA	A	23	98.405	92.446	34.840	1.00	25.70	O
ATOM	182	CB	ALA	A	23	97.273	89.881	36.711	1.00	25.54	C
ATOM	183	N	GLU	A	24	98.283	92.737	37.055	1.00	27.57	N
ATOM	184	CA	GLU	A	24	99.352	93.725	37.024	1.00	30.95	C
ATOM	185	C	GLU	A	24	100.569	93.024	36.449	1.00	30.88	C
ATOM	186	O	GLU	A	24	100.818	91.859	36.753	1.00	30.38	O
ATOM	187	CB	GLU	A	24	99.658	94.276	38.425	1.00	33.75	C
ATOM	188	CG	GLU	A	24	100.218	93.274	39.406	1.00	39.88	C
ATOM	189	CD	GLU	A	24	100.497	93.886	40.774	1.00	43.61	C
ATOM	190	OE1	GLU	A	24	101.322	94.825	40.863	1.00	44.89	O
ATOM	191	OE2	GLU	A	24	99.887	93.422	41.763	1.00	46.51	O
ATOM	192	N	SER	A	25	101.315	93.729	35.606	1.00	32.20	N
ATOM	193	CA	SER	A	25	102.494	93.160	34.971	1.00	33.78	C
ATOM	194	C	SER	A	25	103.714	94.082	35.000	1.00	35.09	C
ATOM	195	O	SER	A	25	103.594	95.289	34.783	1.00	35.62	O
ATOM	196	CB	SER	A	25	102.163	92.803	33.520	1.00	32.84	C
ATOM	197	OG	SER	A	25	103.294	92.273	32.853	1.00	32.95	O
ATOM	198	N	HIS	A	26	104.883	93.501	35.267	1.00	36.35	N
ATOM	199	CA	HIS	A	26	106.136	94.252	35.293	1.00	37.85	C
ATOM	200	C	HIS	A	26	107.125	93.640	34.315	1.00	37.72	C
ATOM	201	O	HIS	A	26	108.333	93.814	34.457	1.00	38.42	O
ATOM	202	CB	HIS	A	26	106.758	94.245	36.685	1.00	40.84	C
ATOM	203	CG	HIS	A	26	105.885	94.852	37.738	1.00	45.91	C
ATOM	204	ND1	HIS	A	26	104.734	94.242	38.195	1.00	48.22	N
ATOM	205	CD2	HIS	A	26	105.978	96.030	38.403	1.00	47.24	C
ATOM	206	CE1	HIS	A	26	104.158	95.017	39.097	1.00	48.99	C

TABLE 7-continued

ATOM	207	NE2	HIS	A	26	104.892	96.107	39.241	1.00	48.85	N
ATOM	208	N	VAL	A	27	106.611	92.922	33.323	1.00	36.55	N
ATOM	209	CA	VAL	A	27	107.462	92.284	32.333	1.00	35.90	C
ATOM	210	C	VAL	A	27	106.851	92.414	30.947	1.00	34.96	C
ATOM	211	O	VAL	A	27	105.689	92.080	30.742	1.00	35.93	O
ATOM	212	CB	VAL	A	27	107.665	90.783	32.670	1.00	37.27	C
ATOM	213	CG1	VAL	A	27	106.315	90.069	32.733	1.00	38.23	C
ATOM	214	CG2	VAL	A	27	108.573	90.130	31.633	1.00	37.72	C
ATOM	215	N	LEU	A	28	107.627	92.922	29.998	1.00	33.88	N
ATOM	216	CA	LEU	A	28	107.132	93.073	28.638	1.00	33.33	C
ATOM	217	C	LEU	A	28	107.190	91.714	27.960	1.00	33.40	C
ATOM	218	O	LEU	A	28	107.946	90.842	28.380	1.00	33.65	O
ATOM	219	CB	LEU	A	28	107.973	94.093	27.868	1.00	32.03	C
ATOM	220	CG	LEU	A	28	107.935	95.515	28.434	1.00	32.97	C
ATOM	221	CD1	LEU	A	28	108.782	96.432	27.584	1.00	31.82	C
ATOM	222	CD2	LEU	A	28	106.516	96.014	28.468	1.00	32.76	C
ATOM	223	N	PRO	A	29	106.384	91.508	26.906	1.00	33.27	N
ATOM	224	CA	PRO	A	29	106.389	90.222	26.211	1.00	33.55	C
ATOM	225	C	PRO	A	29	107.779	89.774	25.759	1.00	34.80	C
ATOM	226	O	PRO	A	29	108.142	88.608	25.909	1.00	33.98	O
ATOM	227	CB	PRO	A	29	105.446	90.480	25.036	1.00	33.09	C
ATOM	228	CG	PRO	A	29	104.465	91.448	25.633	1.00	32.91	C
ATOM	229	CD	PRO	A	29	105.435	92.423	26.248	1.00	33.11	C
ATOM	230	N	ASN	A	30	108.554	90.712	25.222	1.00	36.70	N
ATOM	231	CA	ASN	A	30	109.886	90.412	24.713	1.00	38.86	C
ATOM	232	C	ASN	A	30	110.908	90.077	25.786	1.00	39.09	C
ATOM	233	O	ASN	A	30	112.034	89.703	25.468	1.00	40.70	O
ATOM	234	CB	ASN	A	30	110.405	91.574	23.869	1.00	40.69	C
ATOM	235	CG	ASN	A	30	110.444	92.872	24.644	1.00	43.86	C
ATOM	236	OD1	ASN	A	30	109.404	93.408	25.029	1.00	46.68	O
ATOM	237	ND2	ASN	A	30	111.644	93.379	24.892	1.00	44.75	N
ATOM	238	N	GLU	A	31	110.539	90.205	27.052	1.00	38.38	N
ATOM	239	CA	GLU	A	31	111.483	89.876	28.108	1.00	38.11	C
ATOM	240	C	GLU	A	31	111.012	88.724	28.984	1.00	36.56	C
ATOM	241	O	GLU	A	31	111.606	88.455	30.028	1.00	36.28	O
ATOM	242	CB	GLU	A	31	111.784	91.110	28.966	1.00	41.04	C
ATOM	243	CG	GLU	A	31	110.561	91.828	29.480	1.00	44.82	C
ATOM	244	CD	GLU	A	31	110.907	93.074	30.265	1.00	47.02	C
ATOM	245	OE1	GLU	A	31	111.466	92.948	31.376	1.00	49.39	O
ATOM	246	OE2	GLU	A	31	110.629	94.184	29.765	1.00	48.56	O
ATOM	247	N	VAL	A	32	109.942	88.045	28.572	1.00	34.46	N
ATOM	248	CA	VAL	A	32	109.469	86.912	29.354	1.00	32.34	C
ATOM	249	C	VAL	A	32	110.435	85.761	29.082	1.00	32.04	C
ATOM	250	O	VAL	A	32	110.987	85.648	27.978	1.00	30.35	O
ATOM	251	CB	VAL	A	32	108.040	86.463	28.957	1.00	31.69	C
ATOM	252	CG1	VAL	A	32	107.056	87.578	29.170	1.00	31.19	C
ATOM	253	CG2	VAL	A	32	108.023	86.034	27.535	1.00	34.01	C
ATOM	254	N	ASP	A	33	110.642	84.918	30.092	1.00	31.28	N
ATOM	255	CA	ASP	A	33	111.535	83.773	29.973	1.00	31.91	C
ATOM	256	C	ASP	A	33	110.738	82.549	29.523	1.00	31.62	C
ATOM	257	O	ASP	A	33	109.861	82.079	30.247	1.00	32.49	O
ATOM	258	CB	ASP	A	33	112.191	83.491	31.326	1.00	32.88	C
ATOM	259	CG	ASP	A	33	113.233	82.397	31.252	1.00	33.65	C
ATOM	260	OD1	ASP	A	33	113.723	81.983	32.322	1.00	35.11	O
ATOM	261	OD2	ASP	A	33	113.569	81.959	30.128	1.00	34.94	O
ATOM	262	N	LEU	A	34	111.038	82.037	28.332	1.00	31.40	N
ATOM	263	CA	LEU	A	34	110.334	80.871	27.806	1.00	31.53	C
ATOM	264	C	LEU	A	34	110.977	79.528	28.149	1.00	33.19	C
ATOM	265	O	LEU	A	34	110.436	78.470	27.801	1.00	33.53	O
ATOM	266	CB	LEU	A	34	110.194	80.979	26.285	1.00	30.67	C
ATOM	267	CG	LEU	A	34	108.990	81.696	25.671	1.00	29.76	C
ATOM	268	CD1	LEU	A	34	108.758	83.013	26.322	1.00	31.73	C
ATOM	269	CD2	LEU	A	34	109.229	81.865	24.192	1.00	29.76	C
ATOM	270	N	LYS	A	35	112.122	79.550	28.826	1.00	33.83	N
ATOM	271	CA	LYS	A	35	112.780	78.291	29.159	1.00	34.29	C
ATOM	272	C	LYS	A	35	111.974	77.434	30.114	1.00	33.40	C
ATOM	273	O	LYS	A	35	111.196	77.941	30.934	1.00	32.21	O
ATOM	274	CB	LYS	A	35	114.167	78.521	29.770	1.00	36.57	C
ATOM	275	CG	LYS	A	35	115.196	79.107	28.821	1.00	39.86	C
ATOM	276	CD	LYS	A	35	116.586	79.017	29.440	1.00	43.11	C
ATOM	277	CE	LYS	A	35	116.664	79.750	30.780	1.00	45.95	C
ATOM	278	NZ	LYS	A	35	116.444	81.232	30.640	1.00	49.28	N
ATOM	279	N	THR	A	36	112.169	76.124	30.005	1.00	31.86	N
ATOM	280	CA	THR	A	36	111.484	75.190	30.886	1.00	30.97	C
ATOM	281	C	THR	A	36	112.381	73.969	31.106	1.00	31.69	C
ATOM	282	O	THR	A	36	112.895	73.385	30.146	1.00	31.07	O
ATOM	283	CB	THR	A	36	110.092	74.754	30.298	1.00	28.79	C
ATOM	284	OG1	THR	A	36	109.436	73.879	31.223	1.00	26.65	O
ATOM	285	CG2	THR	A	36	110.257	74.036	28.956	1.00	25.84	C

TABLE 7-continued

ATOM	286	N	LYS	A	37	112.603	73.617	32.368	1.00	32.29	N
ATOM	287	CA	LYS	A	37	113.418	72.450	32.675	1.00	34.79	C
ATOM	288	C	LYS	A	37	112.456	71.305	32.920	1.00	34.78	C
ATOM	289	O	LYS	A	37	111.611	71.375	33.812	1.00	35.62	O
ATOM	290	CB	LYS	A	37	114.291	72.670	33.921	1.00	36.21	C
ATOM	291	CG	LYS	A	37	115.164	71.452	34.243	1.00	39.26	C
ATOM	292	CD	LYS	A	37	116.208	71.705	35.329	1.00	41.30	C
ATOM	293	CE	LYS	A	37	115.590	71.952	36.693	1.00	43.41	C
ATOM	294	NZ	LYS	A	37	116.654	72.208	37.723	1.00	45.01	N
ATOM	295	N	LEU	A	38	112.575	70.261	32.109	1.00	35.03	N
ATOM	296	CA	LEU	A	38	111.702	69.102	32.219	1.00	35.59	C
ATOM	297	C	LEU	A	38	112.319	68.043	33.115	1.00	36.52	C
ATOM	298	O	LEU	A	38	111.614	67.298	33.796	1.00	36.39	O
ATOM	299	CB	LEU	A	38	111.423	68.533	30.825	1.00	33.92	C
ATOM	300	CG	LEU	A	38	110.683	69.502	29.893	1.00	32.62	C
ATOM	301	CD1	LEU	A	38	110.462	68.861	28.531	1.00	31.57	C
ATOM	302	CD2	LEU	A	38	109.356	69.887	30.523	1.00	31.42	C
ATOM	303	N	ALA	A	39	113.644	67.995	33.106	1.00	38.25	N
ATOM	304	CA	ALA	A	39	114.403	67.056	33.915	1.00	40.08	C
ATOM	305	C	ALA	A	39	115.831	67.591	34.003	1.00	41.95	C
ATOM	306	O	ALA	A	39	116.223	68.463	33.220	1.00	42.09	O
ATOM	307	CB	ALA	A	39	114.388	65.677	33.266	1.00	39.28	C
ATOM	308	N	ASP	A	40	116.602	67.073	34.954	1.00	43.87	N
ATOM	309	CA	ASP	A	40	117.993	67.486	35.146	1.00	45.01	C
ATOM	310	C	ASP	A	40	118.722	67.562	33.806	1.00	45.03	C
ATOM	311	O	ASP	A	40	119.467	68.505	33.535	1.00	45.51	O
ATOM	312	CB	ASP	A	40	118.688	66.481	36.060	1.00	46.91	C
ATOM	313	CG	ASP	A	40	118.075	66.436	37.446	1.00	49.68	C
ATOM	314	OD1	ASP	A	40	118.340	65.458	38.180	1.00	51.95	O
ATOM	315	OD2	ASP	A	40	117.345	67.387	37.812	1.00	50.80	O
ATOM	316	N	ASN	A	41	118.487	66.557	32.972	1.00	44.94	N
ATOM	317	CA	ASN	A	41	119.090	66.455	31.642	1.00	44.54	C
ATOM	318	C	ASN	A	41	118.289	67.153	30.545	1.00	43.23	C
ATOM	319	O	ASN	A	41	118.775	67.316	29.422	1.00	42.49	O
ATOM	320	CB	ASN	A	41	119.233	64.969	31.280	1.00	47.24	C
ATOM	321	CG	ASN	A	41	118.956	64.687	29.801	1.00	48.33	C
ATOM	322	OD1	ASN	A	41	119.714	65.095	28.922	1.00	50.74	O
ATOM	323	ND2	ASN	A	41	117.852	64.001	29.530	1.00	47.16	N
ATOM	324	N	LEU	A	42	117.074	67.589	30.866	1.00	41.33	N
ATOM	325	CA	LEU	A	42	116.227	68.186	29.845	1.00	39.00	C
ATOM	326	C	LEU	A	42	115.637	69.573	30.120	1.00	37.99	C
ATOM	327	O	LEU	A	42	114.653	69.716	30.848	1.00	37.43	O
ATOM	328	CB	LEU	A	42	115.102	67.200	29.532	1.00	38.42	C
ATOM	329	CG	LEU	A	42	114.599	67.104	28.099	1.00	37.18	C
ATOM	330	CD1	LEU	A	42	115.752	66.736	27.172	1.00	36.38	C
ATOM	331	CD2	LEU	A	42	113.509	66.047	28.032	1.00	36.67	C
ATOM	332	N	THR	A	43	116.242	70.586	29.511	1.00	35.65	N
ATOM	333	CA	THR	A	43	115.783	71.960	29.639	1.00	34.45	C
ATOM	334	C	THR	A	43	115.610	72.521	28.232	1.00	33.69	C
ATOM	335	O	THR	A	43	116.539	72.482	27.421	1.00	33.77	O
ATOM	336	CB	THR	A	43	116.792	72.827	30.404	1.00	34.76	C
ATOM	337	OG1	THR	A	43	116.874	72.372	31.755	1.00	36.40	O
ATOM	338	CG2	THR	A	43	116.358	74.281	30.402	1.00	35.16	C
ATOM	339	N	LEU	A	44	114.421	73.039	27.936	1.00	31.23	N
ATOM	340	CA	LEU	A	44	114.157	73.578	26.614	1.00	28.88	C
ATOM	341	C	LEU	A	44	114.097	75.095	26.683	1.00	27.97	C
ATOM	342	O	LEU	A	44	113.799	75.655	27.733	1.00	29.11	O
ATOM	343	CB	LEU	A	44	112.830	73.016	26.094	1.00	28.32	C
ATOM	344	CG	LEU	A	44	112.680	71.487	26.107	1.00	27.65	C
ATOM	345	CD1	LEU	A	44	111.299	71.107	25.598	1.00	26.79	C
ATOM	346	CD2	LEU	A	44	113.756	70.840	25.248	1.00	28.11	C
ATOM	347	N	ASN	A	45	114.380	75.756	25.565	1.00	26.86	N
ATOM	348	CA	ASN	A	45	114.337	77.215	25.492	1.00	27.18	C
ATOM	349	C	ASN	A	45	112.933	77.752	25.191	1.00	27.96	C
ATOM	350	O	ASN	A	45	112.680	78.947	25.312	1.00	27.92	O
ATOM	351	CB	ASN	A	45	115.323	77.699	24.443	1.00	27.75	C
ATOM	352	CG	ASN	A	45	116.755	77.510	24.878	1.00	28.46	C
ATOM	353	OD1	ASN	A	45	117.644	77.325	24.051	1.00	30.13	O
ATOM	354	ND2	ASN	A	45	116.993	77.579	26.184	1.00	27.73	N
ATOM	355	N	ILE	A	46	112.033	76.863	24.777	1.00	27.88	N
ATOM	356	CA	ILE	A	46	110.636	77.213	24.516	1.00	26.86	C
ATOM	357	C	ILE	A	46	109.848	75.975	24.946	1.00	27.09	C
ATOM	358	O	ILE	A	46	110.282	74.843	24.701	1.00	27.35	O
ATOM	359	CB	ILE	A	46	110.375	77.537	23.028	1.00	25.10	C
ATOM	360	CG1	ILE	A	46	110.724	76.340	22.147	1.00	25.03	C
ATOM	361	CG2	ILE	A	46	111.182	78.756	22.632	1.00	26.47	C
ATOM	362	CD1	ILE	A	46	110.468	76.573	20.657	1.00	22.34	C
ATOM	363	N	PRO	A	47	108.702	76.170	25.626	1.00	25.80	N
ATOM	364	CA	PRO	A	47	107.849	75.082	26.112	1.00	24.42	C

TABLE 7-continued

ATOM	365	C	PRO	A	47	107.077	74.339	25.024	1.00	24.61	C
ATOM	366	O	PRO	A	47	105.912	73.988	25.223	1.00	23.97	O
ATOM	367	CB	PRO	A	47	106.929	75.808	27.083	1.00	23.99	C
ATOM	368	CG	PRO	A	47	106.697	77.097	26.351	1.00	23.63	C
ATOM	369	CD	PRO	A	47	108.135	77.467	26.036	1.00	24.98	C
ATOM	370	N	ILE	A	48	107.735	74.063	23.901	1.00	23.91	N
ATOM	371	CA	ILE	A	48	107.083	73.395	22.784	1.00	24.05	C
ATOM	372	C	ILE	A	48	107.730	72.083	22.322	1.00	24.29	C
ATOM	373	O	ILE	A	48	108.943	72.013	22.098	1.00	23.94	O
ATOM	374	CB	ILE	A	48	106.997	74.368	21.592	1.00	25.68	C
ATOM	375	CG1	ILE	A	48	106.193	75.605	22.009	1.00	25.65	C
ATOM	376	CG2	ILE	A	48	106.376	73.675	20.379	1.00	25.11	C
ATOM	377	CD1	ILE	A	48	106.124	76.678	20.949	1.00	26.76	C
ATOM	378	N	ILE	A	49	106.897	71.054	22.162	1.00	23.20	N
ATOM	379	CA	ILE	A	49	107.343	69.732	21.725	1.00	23.13	C
ATOM	380	C	ILE	A	49	106.454	69.215	20.588	1.00	23.01	C
ATOM	381	O	ILE	A	49	105.241	69.397	20.623	1.00	22.62	O
ATOM	382	CB	ILE	A	49	107.274	68.723	22.876	1.00	22.04	C
ATOM	383	CG1	ILE	A	49	108.027	69.277	24.093	1.00	20.85	C
ATOM	384	CG2	ILE	A	49	107.847	67.376	22.412	1.00	21.51	C
ATOM	385	CD1	ILE	A	49	107.922	68.416	25.333	1.00	19.42	C
ATOM	386	N	THR	A	50	107.059	68.573	19.587	1.00	22.84	N
ATOM	387	CA	THR	A	50	106.303	68.049	18.449	1.00	23.78	C
ATOM	388	C	THR	A	50	105.913	66.582	18.643	1.00	24.70	C
ATOM	389	O	THR	A	50	106.746	65.746	18.989	1.00	25.64	O
ATOM	390	CB	THR	A	50	107.096	68.200	17.126	1.00	23.25	C
ATOM	391	OG1	THR	A	50	108.344	67.503	17.219	1.00	24.27	O
ATOM	392	CG2	THR	A	50	107.360	69.666	16.838	1.00	23.48	C
ATOM	393	N	ALA	A	50	104.641	66.279	18.401	1.00	24.84	N
ATOM	394	CA	ALA	A	51	104.100	64.937	18.576	1.00	24.13	C
ATOM	395	C	ALA	A	51	104.842	63.813	17.849	1.00	25.28	C
ATOM	396	O	ALA	A	51	105.385	63.997	16.760	1.00	24.45	O
ATOM	397	CB	ALA	A	51	102.638	64.931	18.183	1.00	23.17	C
ATOM	398	N	ALA	A	52	104.852	62.639	18.477	1.00	26.02	N
ATOM	399	CA	ALA	A	52	105.496	61.450	17.932	1.00	26.54	C
ATOM	400	C	ALA	A	52	104.539	60.787	16.945	1.00	26.47	C
ATOM	401	O	ALA	A	52	104.097	59.660	17.146	1.00	26.78	O
ATOM	402	CB	ALA	A	52	105.833	60.484	19.063	1.00	25.79	C
HETATM	403	N	MSE	A	53	104.221	61.496	15.871	1.00	27.09	N
HETATM	404	CA	MSE	A	53	103.294	60.985	14.868	1.00	27.91	C
HETATM	405	C	MSE	A	53	103.997	60.874	13.532	1.00	27.12	C
HETATM	406	O	MSE	A	53	104.710	61.790	13.133	1.00	26.01	O
HETATM	407	CB	MSE	A	53	102.094	61.932	14.775	1.00	29.38	C
HETATM	408	CG	MSE	A	53	101.381	62.108	16.124	1.00	32.60	C
HETATM	409	SE	MSE	A	53	99.997	63.279	16.089	1.00	36.50	SE
HETATM	410	CE	MSE	A	53	100.826	64.714	15.572	1.00	38.59	C
ATOM	411	N	ASP	A	54	103.790	59.757	12.837	1.00	27.85	N
ATOM	412	CA	ASP	A	54	104.443	59.546	11.550	1.00	28.83	C
ATOM	413	C	ASP	A	54	104.108	60.560	10.460	1.00	29.48	C
ATOM	414	O	ASP	A	54	104.665	60.493	9.366	1.00	30.74	O
ATOM	415	CB	ASP	A	54	104.212	58.113	11.049	1.00	29.72	C
ATOM	416	CG	ASP	A	54	102.754	57.784	10.826	1.00	31.41	C
ATOM	417	OD1	ASP	A	54	102.474	56.604	10.539	1.00	34.67	O
ATOM	418	OD2	ASP	A	54	101.888	58.674	10.925	1.00	32.27	O
ATOM	419	N	THR	A	55	103.211	61.501	10.753	1.00	29.32	N
ATOM	420	CA	THR	A	55	102.850	62.548	9.796	1.00	27.93	C
ATOM	421	C	THR	A	55	103.282	63.914	10.328	1.00	27.76	C
ATOM	422	O	THR	A	55	102.985	64.945	9.728	1.00	27.97	O
ATOM	423	CB	THR	A	55	101.328	62.574	9.497	1.00	28.66	C
ATOM	424	OG1	THR	A	55	100.584	62.643	10.721	1.00	28.50	O
ATOM	425	CG2	THR	A	55	100.915	61.334	8.720	1.00	28.74	C
ATOM	426	N	VAL	A	56	103.997	63.912	11.454	1.00	26.53	N
ATOM	427	CA	VAL	A	56	104.479	65.153	12.061	1.00	25.82	C
ATOM	429	C	VAL	A	56	105.975	65.173	12.392	1.00	25.65	C
ATOM	429	O	VAL	A	56	106.675	66.085	11.977	1.00	27.06	O
ATOM	430	CB	VAL	A	56	103.700	65.500	13.361	1.00	24.87	C
ATOM	431	CG1	VAL	A	56	104.243	66.781	13.975	1.00	23.59	C
ATOM	432	CG2	VAL	A	56	102.230	65.679	13.052	1.00	24.94	C
ATOM	433	N	THR	A	57	106.487	64.178	13.108	1.00	25.55	N
ATOM	434	CA	THR	A	57	107.895	64.235	13.479	1.00	24.90	C
ATOM	435	C	THR	A	57	108.881	63.190	12.993	1.00	25.70	C
ATOM	436	O	THR	A	57	108.933	62.077	13.510	1.00	26.76	O
ATOM	437	CB	THR	A	57	108.070	64.304	15.022	1.00	24.37	C
ATOM	438	OG1	THR	A	57	107.342	65.420	15.536	1.00	24.74	O
ATOM	439	CG2	THR	A	57	109.535	64.499	15.391	1.00	22.67	C
ATOM	440	N	GLY	A	58	109.696	63.592	12.025	1.00	25.19	N
ATOM	441	CA	GLY	A	58	110.762	62.749	11.517	1.00	24.08	C
ATOM	442	C	GLY	A	58	112.004	63.541	11.912	1.00	23.78	C
ATOM	443	O	GLY	A	58	111.881	64.497	12.682	1.00	21.95	O

TABLE 7-continued

ATOM	444	N	SER	A	59	113.180	63.179	11.399	1.00	24.38	N
ATOM	445	CA	SER	A	59	114.417	63.901	11.723	1.00	24.47	C
ATOM	446	C	SER	A	59	114.406	65.388	11.318	1.00	24.98	C
ATOM	447	O	SER	A	59	114.915	66.229	12.052	1.00	25.40	O
ATOM	448	CB	SER	A	59	115.614	63.193	11.090	1.00	23.93	C
ATOM	449	OG	SER	A	59	115.404	62.980	9.705	1.00	26.47	O
ATOM	450	N	LYS	A	60	113.836	65.710	10.156	1.00	25.85	N
ATOM	451	CA	LYS	A	60	113.747	67.103	9.702	1.00	26.54	C
ATOM	452	C	LYS	A	60	112.985	67.987	10.696	1.00	25.73	C
ATOM	453	O	LYS	A	60	113.389	69.118	10.983	1.00	25.68	O
ATOM	454	CB	LYS	A	60	113.029	67.190	8.358	1.00	27.44	C
ATOM	455	CG	LYS	A	60	113.902	67.124	7.148	1.00	31.91	C
ATOM	456	CD	LYS	A	60	113.034	67.048	5.878	1.00	35.71	C
ATOM	457	CE	LYS	A	60	112.071	68.237	5.710	1.00	36.50	C
ATOM	458	NZ	LYS	A	60	112.742	69.542	5.417	1.00	38.79	N
HETATM	459	N	MSE	A	61	111.864	67.482	11.196	1.00	25.26	N
HETATM	460	CA	MSE	A	61	111.060	68.242	12.140	1.00	25.61	C
HETATM	461	C	MSE	A	61	111.773	68.317	13.482	1.00	24.55	C
HETATM	462	O	MSE	A	61	111.805	69.373	14.115	1.00	24.99	O
HETATM	463	CB	MSE	A	61	109.678	67.587	12.295	1.00	27.32	C
HETATM	464	CG	MSE	A	61	108.708	68.290	13.258	1.00	29.47	C
HETATM	465	SE	MSE	A	61	108.189	69.988	12.808	1.00	35.03	SE
HETATM	466	CE	MSE	A	61	109.528	70.965	13.376	1.00	35.39	C
ATOM	467	N	ALA	A	62	112.343	67.194	13.914	1.00	23.85	N
ATOM	468	CA	ALA	A	62	113.065	67.144	15.184	1.00	23.20	C
ATOM	469	C	ALA	A	62	114.223	68.124	15.141	1.00	22.77	C
ATOM	470	O	ALA	A	62	114.588	68.717	16.147	1.00	22.10	O
ATOM	471	CB	ALA	A	62	113.581	65.747	15.445	1.00	23.29	C
ATOM	472	N	ILE	A	63	114.798	68.292	13.959	1.00	22.99	N
ATOM	473	CA	ILE	A	63	115.898	69.221	13.775	1.00	23.52	C
ATOM	474	C	ILE	A	63	115.426	70.683	13.828	1.00	24.19	C
ATOM	475	O	ILE	A	63	116.042	71.519	14.514	1.00	23.98	O
ATOM	476	CB	ILE	A	63	116.606	68.934	12.442	1.00	23.78	C
ATOM	477	CG1	ILE	A	63	117.400	67.627	12.569	1.00	24.18	C
ATOM	478	CG2	ILE	A	63	117.476	70.110	12.047	1.00	25.35	C
ATOM	479	CD1	ILE	A	63	118.130	67.209	11.319	1.00	26.14	C
ATOM	480	N	ALA	A	64	114.326	70.981	13.129	1.00	24.07	N
ATOM	481	CA	ALA	A	64	113.762	72.335	13.091	1.00	23.68	C
ATOM	482	C	ALA	A	64	113.230	72.799	14.447	1.00	23.69	C
ATOM	483	O	ALA	A	64	113.452	73.943	14.847	1.00	24.51	O
ATOM	484	CB	ALA	A	64	112.649	72.418	12.052	1.00	22.06	C
ATOM	485	N	ILE	A	65	112.528	71.927	15.161	1.00	23.23	N
ATOM	486	CA	ILE	A	65	111.993	72.336	16.456	1.00	23.60	C
ATOM	487	C	ILE	A	65	113.100	72.513	17.500	1.00	23.66	C
ATOM	488	O	ILE	A	65	112.983	73.332	18.416	1.00	23.86	O
ATOM	489	CB	ILE	A	65	110.932	71.324	16.980	1.00	23.74	C
ATOM	490	CG1	ILE	A	65	110.372	71.801	18.326	1.00	23.72	C
ATOM	491	CG2	ILE	A	65	111.541	69.929	17.108	1.00	23.00	C
ATOM	492	CD1	ILE	A	65	109.618	73.128	18.258	1.00	23.28	C
ATOM	493	N	ALA	A	66	114.169	71.739	17.370	1.00	23.35	N
ATOM	494	CA	ALA	A	66	115.277	71.845	18.310	1.00	24.29	C
ATOM	495	C	ALA	A	66	116.019	73.163	18.037	1.00	23.90	C
ATOM	496	O	ALA	A	66	116.379	73.888	18.970	1.00	23.78	O
ATOM	497	CB	ALA	A	66	116.222	70.639	18.164	1.00	24.32	C
ATOM	498	N	ARG	A	67	116.236	73.480	16.762	1.00	22.77	N
ATOM	499	CA	ARG	A	67	116.916	74.725	16.415	1.00	23.18	C
ATOM	500	C	ARG	A	67	116.158	75.926	16.954	1.00	23.38	C
ATOM	501	O	ARG	A	67	116.747	76.955	17.274	1.00	23.27	O
ATOM	502	CB	ARG	A	67	117.061	74.850	14.900	1.00	23.27	C
ATOM	503	CG	ARG	A	67	118.069	73.896	14.321	1.00	25.02	C
ATOM	504	CD	ARG	A	67	118.110	73.962	12.806	1.00	25.68	C
ATOM	505	NE	ARG	A	67	119.304	73.292	12.310	1.00	27.14	N
ATOM	506	CZ	ARG	A	67	119.562	73.049	11.032	1.00	28.72	C
ATOM	507	NH1	ARG	A	67	118.707	73.415	10.088	1.00	30.38	N
ATOM	508	NH2	ARG	A	67	120.694	72.451	10.698	1.00	30.93	N
ATOM	509	N	ALA	A	68	114.842	75.791	17.053	1.00	23.80	N
ATOM	510	CA	ALA	A	68	114.006	76.871	17.555	1.00	24.57	C
ATOM	511	C	ALA	A	68	114.011	76.902	19.083	1.00	24.29	C
ATOM	512	O	ALA	A	68	113.504	77.839	19.691	1.00	25.66	O
ATOM	513	CB	ALA	A	68	112.582	76.714	17.032	1.00	24.39	C
ATOM	514	N	GLY	A	69	114.582	75.876	19.704	1.00	24.27	N
ATOM	515	CA	GLY	A	69	114.632	75.844	21.154	1.00	23.26	C
ATOM	516	C	GLY	A	69	113.718	74.804	21.764	1.00	23.92	C
ATOM	517	O	GLY	A	69	113.633	74.691	22.986	1.00	24.04	O
ATOM	518	N	GLY	A	70	113.038	74.036	20.918	1.00	23.60	N
ATOM	519	CA	GLY	A	70	112.124	73.025	21.416	1.00	23.82	C
ATOM	520	C	GLY	A	70	112.661	71.607	21.404	1.00	24.81	C
ATOM	521	O	GLY	A	70	113.873	71.383	21.370	1.00	24.12	O
ATOM	522	N	LEU	A	71	111.745	70.643	21.430	1.00	24.57	N

TABLE 7-continued

ATOM	523	CA	LEU	A	71	112.113	69.235	21.436	1.00	24.66	C
ATOM	524	C	LEU	A	71	111.237	68.454	20.473	1.00	25.01	C
ATOM	525	O	LEU	A	71	110.023	68.641	20.443	1.00	26.48	O
ATOM	526	CB	LEU	A	71	111.945	68.653	22.842	1.00	23.51	C
ATOM	527	CG	LEU	A	71	112.350	67.193	23.025	1.00	23.35	C
ATOM	528	CD1	LEU	A	71	113.832	67.082	22.735	1.00	24.00	C
ATOM	529	CD2	LEU	A	71	112.053	66.716	24.441	1.00	21.93	C
ATOM	530	N	GLY	A	72	111.858	67.589	19.682	1.00	24.71	N
ATOM	531	CA	GLY	A	72	111.110	66.767	18.751	1.00	24.20	C
ATOM	532	C	GLY	A	72	111.122	65.316	19.216	1.00	23.85	C
ATOM	533	O	GLY	A	72	112.148	64.816	19.671	1.00	24.20	O
ATOM	534	N	VAL	A	73	109.980	64.643	19.116	1.00	23.07	N
ATOM	535	CA	VAL	A	73	109.874	63.247	19.519	1.00	23.30	C
ATOM	536	C	VAL	A	73	109.683	62.388	18.269	1.00	23.74	C
ATOM	537	O	VAL	A	73	108.610	62.387	17.664	1.00	23.75	O
ATOM	538	CB	VAL	A	73	108.680	63.043	20.496	1.00	22.77	C
ATOM	539	CG1	VAL	A	73	108.604	61.590	20.950	1.00	22.04	C
ATOM	540	CG2	VAL	A	73	108.835	63.970	21.703	1.00	20.60	C
ATOM	541	N	ILE	A	74	110.742	61.680	17.874	1.00	25.21	N
ATOM	542	CA	ILE	A	74	110.698	60.822	16.690	1.00	26.76	C
ATOM	543	C	ILE	A	74	109.751	59.668	16.939	1.00	28.54	C
ATOM	544	O	ILE	A	74	109.871	58.932	17.917	1.00	28.80	O
ATOM	545	CB	ILE	A	74	112.070	60.216	16.332	1.00	27.10	C
ATOM	546	CG1	ILE	A	74	113.127	61.317	16.167	1.00	27.28	C
ATOM	547	CG2	ILE	A	74	111.934	59.376	15.058	1.00	25.49	C
ATOM	548	CD1	ILE	A	74	112.841	62.293	15.058	1.00	29.69	C
ATOM	549	N	HIS	A	75	108.808	59.517	16.029	1.00	31.17	N
ATOM	550	CA	HIS	A	75	107.800	58.482	16.111	1.00	34.55	C
ATOM	551	C	HIS	A	75	108.375	57.081	15.924	1.00	34.59	C
ATOM	552	O	HIS	A	75	109.427	56.904	15.301	1.00	34.10	O
ATOM	553	CB	HIS	A	75	106.758	58.798	15.065	1.00	39.30	C
ATOM	554	CG	HIS	A	75	107.336	59.466	13.861	1.00	46.72	C
ATOM	555	ND1	HIS	A	75	108.504	59.030	13.267	1.00	50.41	N
ATOM	556	CD2	HIS	A	75	106.850	60.439	13.055	1.00	50.89	C
ATOM	557	CE1	HIS	A	75	108.706	59.698	12.143	1.00	51.89	C
ATOM	558	NE2	HIS	A	75	107.716	60.561	11.990	1.00	53.11	N
ATOM	559	N	LYS	A	76	107.666	56.086	16.458	1.00	34.75	N
ATOM	560	CA	LYS	A	76	108.097	54.688	16.409	1.00	35.86	C
ATOM	561	C	LYS	A	76	107.398	53.821	15.349	1.00	36.31	C
ATOM	562	O	LYS	A	76	107.467	52.586	15.391	1.00	36.33	O
ATOM	563	CB	LYS	A	76	107.896	54.063	17.790	1.00	35.61	C
ATOM	564	CG	LYS	A	76	106.439	54.013	18.235	1.00	36.48	C
ATOM	565	CD	LYS	A	76	106.313	53.405	19.624	1.00	38.36	C
ATOM	566	CE	LYS	A	76	104.892	52.950	19.910	1.00	38.72	C
ATOM	567	NZ	LYS	A	76	103.918	54.041	19.706	1.00	40.04	N
ATOM	568	N	ASN	A	77	106.736	54.461	14.394	1.00	36.56	N
ATOM	569	CA	ASN	A	77	106.031	53.723	13.360	1.00	36.37	C
ATOM	570	C	ASN	A	77	107.032	53.345	12.265	1.00	36.27	C
ATOM	571	O	ASN	A	77	106.823	53.619	11.077	1.00	36.44	O
ATOM	572	CB	ASN	A	77	104.904	54.587	12.784	1.00	37.00	C
ATOM	573	CG	ASN	A	77	103.721	53.770	12.312	1.00	37.48	C
ATOM	574	OD1	ASN	A	77	103.882	52.747	11.647	1.00	38.78	O
ATOM	575	ND2	ASN	A	77	102.520	54.232	12.634	1.00	37.68	N
HETATM	576	N	MSE	A	78	108.132	52.730	12.681	1.00	35.58	N
HETATM	577	CA	MSE	A	78	109.177	52.293	11.758	1.00	36.20	C
HETATM	578	C	MSE	A	78	110.104	51.313	12.475	1.00	35.86	C
HETATM	579	O	MSE	A	78	110.038	51.188	13.694	1.00	36.31	O
HETATM	580	CB	MSE	A	78	109.956	53.500	11.207	1.00	37.66	C
HETATM	581	CG	MSE	A	78	110.414	54.534	12.237	1.00	39.57	C
HETATM	582	SE	MSE	A	78	111.321	55.923	11.449	1.00	43.88	SE
HETATM	583	CE	MSE	A	78	111.298	57.131	12.764	1.00	43.70	C
ATOM	584	N	SER	A	79	110.956	50.606	11.739	1.00	34.43	N
ATOM	585	CA	SER	A	79	111.828	49.639	12.391	1.00	34.01	C
ATOM	586	C	SER	A	79	112.734	50.315	13.421	1.00	34.22	C
ATOM	587	O	SER	A	79	112.961	51.525	13.356	1.00	34.05	O
ATOM	588	CB	SER	A	79	112.676	48.897	11.362	1.00	32.01	C
ATOM	589	OG	SER	A	79	113.613	49.764	10.771	1.00	31.21	O
ATOM	590	N	ILE	A	80	113.229	49.528	14.378	1.00	33.98	N
ATOM	591	CA	ILE	A	80	114.123	50.031	15.418	1.00	34.25	C
ATOM	592	C	ILE	A	80	115.356	50.641	14.759	1.00	34.44	C
ATOM	593	O	ILE	A	80	115.847	51.687	15.177	1.00	34.28	O
ATOM	594	CB	ILE	A	80	114.574	48.895	16.369	1.00	33.95	C
ATOM	595	CG1	ILE	A	80	113.366	48.322	17.105	1.00	33.91	C
ATOM	596	CG2	ILE	A	80	115.594	49.416	17.369	1.00	34.09	C
ATOM	597	CD1	ILE	A	80	113.714	47.217	18.090	1.00	34.10	C
ATOM	598	N	THR	A	81	115.849	49.976	13.720	1.00	34.69	N
ATOM	599	CA	THR	A	81	117.017	50.450	12.991	1.00	34.33	C
ATOM	600	C	THR	A	81	116.719	51.788	12.306	1.00	34.17	C
ATOM	601	O	THR	A	81	117.533	52.708	12.365	1.00	34.07	O

TABLE 7-continued

ATOM	602	CB	THR	A	81	117.472	49.393	11.944	1.00	33.53	C
ATOM	603	OG1	THR	A	81	117.988	48.248	12.627	1.00	33.84	O
ATOM	604	CG2	THR	A	81	118.542	49.942	11.036	1.00	33.63	C
ATOM	605	N	GLU	A	82	115.550	51.895	11.674	1.00	34.36	N
ATOM	606	CA	GLU	A	82	115.148	53.117	10.973	1.00	33.72	C
ATOM	607	C	GLU	A	82	114.936	54.269	11.941	1.00	32.06	C
ATOM	608	O	GLU	A	82	115.289	55.407	11.642	1.00	31.19	O
ATOM	609	CB	GLU	A	82	113.853	52.884	10.188	1.00	37.28	C
ATOM	610	CG	GLU	A	82	113.953	51.828	9.093	1.00	42.63	C
ATOM	611	CD	GLU	A	82	112.589	51.420	8.520	1.00	45.15	C
ATOM	612	OE1	GLU	A	82	111.711	50.979	9.302	1.00	44.54	O
ATOM	613	OE2	GLU	A	82	112.404	51.530	7.284	1.00	47.14	O
ATOM	614	N	GLN	A	83	114.354	53.978	13.100	1.00	30.48	N
ATOM	615	CA	GLN	A	83	114.107	55.022	14.080	1.00	29.17	C
ATOM	616	C	GLN	A	83	115.413	55.520	14.694	1.00	29.61	C
ATOM	617	O	GLN	A	83	115.565	56.720	14.947	1.00	30.50	O
ATOM	618	CB	GLN	A	83	113.178	54.526	15.186	1.00	27.78	C
ATOM	619	CG	GLN	A	83	112.691	55.646	16.087	1.00	26.47	C
ATOM	620	CD	GLN	A	83	111.897	55.160	17.277	1.00	25.24	C
ATOM	621	OE1	GLN	A	83	111.368	55.960	18.048	1.00	27.62	O
ATOM	622	NE2	GLN	A	83	111.817	53.851	17.444	1.00	25.23	N
ATOM	623	N	ALA	A	84	116.353	54.604	14.929	1.00	29.43	N
ATOM	624	CA	ALA	A	84	117.654	54.955	15.501	1.00	28.41	C
ATOM	625	C	ALA	A	84	118.472	55.837	14.559	1.00	28.88	C
ATOM	626	O	ALA	A	84	119.146	56.766	14.998	1.00	29.24	O
ATOM	627	CB	ALA	A	84	118.427	53.704	15.826	1.00	27.73	C
ATOM	628	N	GLU	A	85	118.416	55.535	13.267	1.00	28.73	N
ATOM	629	CA	GLU	A	85	119.139	56.298	12.260	1.00	31.28	C
ATOM	630	C	GLU	A	85	118.518	57.684	12.123	1.00	31.60	C
ATOM	631	O	GLU	A	85	119.203	58.673	11.854	1.00	30.88	O
ATOM	632	CB	GLU	A	85	119.072	55.557	10.922	1.00	34.79	C
ATOM	633	CG	GLU	A	85	119.767	56.251	9.762	1.00	40.50	C
ATOM	634	CD	GLU	A	85	121.231	56.553	10.051	1.00	43.61	C
ATOM	635	OE1	GLU	A	85	121.984	55.612	10.413	1.00	44.96	O
ATOM	636	OE2	GLU	A	85	121.624	57.736	9.905	1.00	44.87	O
ATOM	637	N	GLU	A	86	117.204	57.739	12.300	1.00	31.99	N
ATOM	638	CA	GLU	A	86	116.452	58.983	12.232	1.00	32.20	C
ATOM	639	C	GLU	A	86	116.996	59.854	13.382	1.00	32.56	C
ATOM	640	O	GLU	A	86	117.257	61.053	13.218	1.00	32.08	O
ATOM	641	CB	GLU	A	86	114.972	58.667	12.449	1.00	33.98	C
ATOM	642	CG	GLU	A	86	114.002	59.724	11.988	1.00	38.81	C
ATOM	643	CD	GLU	A	86	113.971	59.856	10.480	1.00	40.86	C
ATOM	644	OE1	GLU	A	86	113.133	60.628	9.969	1.00	42.44	O
ATOM	645	OE2	GLU	A	86	114.785	59.190	9.807	1.00	41.41	O
ATOM	646	N	VAL	A	87	117.176	59.225	14.543	1.00	31.45	N
ATOM	647	CA	VAL	A	87	117.701	59.890	15.725	1.00	31.84	C
ATOM	648	C	VAL	A	87	119.146	60.342	15.513	1.00	32.90	C
ATOM	649	O	VAL	A	87	119.515	61.458	15.893	1.00	32.72	O
ATOM	650	CB	VAL	A	87	117.637	58.952	16.950	1.00	31.80	C
ATOM	651	CG1	VAL	A	87	118.476	59.511	18.099	1.00	31.50	C
ATOM	652	CG2	VAL	A	87	116.196	58.796	17.394	1.00	30.99	C
ATOM	653	N	ARG	A	88	119.969	59.481	14.920	1.00	32.89	N
ATOM	654	CA	ARG	A	88	121.353	59.860	14.679	1.00	33.91	C
ATOM	655	C	ARG	A	88	121.385	61.104	13.813	1.00	33.69	C
ATOM	656	O	ARG	A	88	122.176	62.007	14.060	1.00	34.42	O
ATOM	657	CB	ARG	A	88	122.142	58.740	13.989	1.00	35.05	C
ATOM	658	CG	ARG	A	88	122.412	57.533	14.861	1.00	38.65	C
ATOM	659	CD	ARG	A	88	123.375	56.540	14.195	1.00	40.90	C
ATOM	660	NE	ARG	A	88	123.796	55.505	15.141	1.00	43.00	N
ATOM	661	CZ	ARG	A	88	123.038	54.493	15.550	1.00	43.55	C
ATOM	662	NH1	ARG	A	88	123.515	53.610	16.421	1.00	43.61	N
ATOM	663	NH2	ARG	A	88	121.819	54.340	15.060	1.00	45.10	N
ATOM	664	N	LYS	A	89	120.519	61.167	12.805	1.00	33.67	N
ATOM	665	CA	LYS	A	89	120.509	62.331	11.929	1.00	33.25	C
ATOM	666	C	LYS	A	89	120.348	63.618	12.703	1.00	32.41	C
ATOM	667	O	LYS	A	89	120.956	64.630	12.356	1.00	33.80	O
ATOM	668	CB	LYS	A	89	119.406	62.243	10.873	1.00	33.93	C
ATOM	669	CG	LYS	A	89	119.689	61.251	9.758	1.00	37.76	C
ATOM	670	CD	LYS	A	89	118.720	61.454	8.596	1.00	39.45	C
ATOM	671	CE	LYS	A	89	118.999	60.487	7.453	1.00	39.82	C
ATOM	672	NZ	LYS	A	89	118.777	59.074	7.855	1.00	42.12	N
ATOM	673	N	VAL	A	90	119.539	63.597	13.755	1.00	30.97	N
ATOM	674	CA	VAL	A	90	119.346	64.811	14.526	1.00	29.42	C
ATOM	675	C	VAL	A	90	120.612	65.152	15.304	1.00	29.81	C
ATOM	676	O	VAL	A	90	120.989	66.327	15.402	1.00	29.55	O
ATOM	677	CB	VAL	A	90	118.145	64.690	15.494	1.00	27.62	C
ATOM	678	CG1	VAL	A	90	118.020	65.958	16.335	1.00	26.39	C
ATOM	679	CG2	VAL	A	90	116.863	64.484	14.697	1.00	25.45	C
ATOM	680	N	LYS	A	91	121.280	64.132	15.839	1.00	30.20	N

TABLE 7-continued

ATOM	681	CA	LYS	A	91	122.502	64.372	16.607	1.00	30.65	C
ATOM	682	C	LYS	A	91	123.646	64.827	15.701	1.00	30.99	C
ATOM	683	O	LYS	A	91	124.487	65.625	16.105	1.00	32.06	O
ATOM	684	CB	LYS	A	91	122.921	63.113	17.371	1.00	28.83	C
ATOM	685	CG	LYS	A	91	121.862	62.546	18.307	1.00	28.25	C
ATOM	686	CD	LYS	A	91	121.288	63.582	19.281	1.00	28.84	C
ATOM	687	CE	LYS	A	91	122.332	64.181	20.217	1.00	27.53	C
ATOM	688	NZ	LYS	A	91	121.726	65.148	21.203	1.00	28.66	N
ATOM	689	N	ARG	A	92	123.664	64.329	14.470	1.00	32.03	N
ATOM	690	CA	ARG	A	92	124.708	64.678	13.513	1.00	33.25	C
ATOM	691	C	ARG	A	92	124.491	66.031	12.856	1.00	33.96	C
ATOM	692	O	ARG	A	92	125.369	66.532	12.151	1.00	35.10	O
ATOM	693	CB	ARG	A	92	124.790	63.627	12.409	1.00	34.10	C
ATOM	694	CG	ARG	A	92	125.206	62.236	12.834	1.00	35.26	C
ATOM	695	CD	ARG	A	92	126.593	62.227	13.424	1.00	38.81	C
ATOM	696	NE	ARG	A	92	127.118	60.867	13.504	1.00	40.97	N
ATOM	697	CZ	ARG	A	92	128.235	60.524	14.142	1.00	42.15	C
ATOM	698	NH1	ARG	A	92	128.962	61.443	14.771	1.00	41.49	N
ATOM	699	NH2	ARG	A	92	128.622	59.254	14.148	1.00	43.12	N
ATOM	700	N	SER	A	93	123.325	66.625	13.075	1.00	34.14	N
ATOM	701	CA	SER	A	93	123.016	67.910	12.461	1.00	34.71	C
ATOM	702	C	SER	A	93	124.039	69.013	12.806	1.00	35.09	C
ATOM	703	O	SER	A	93	124.714	69.554	11.924	1.00	35.54	O
ATOM	704	CB	SER	A	93	121.601	68.342	12.863	1.00	34.35	C
ATOM	705	OG	SER	A	93	121.171	69.453	12.097	1.00	33.84	O
ATOM	706	N	GLU	A	94	124.148	69.343	14.087	1.00	35.16	N
ATOM	707	CA	GLU	A	94	125.077	70.367	14.545	1.00	35.95	C
ATOM	708	C	GLU	A	94	126.125	69.754	15.462	1.00	34.73	C
ATOM	709	O	GLU	A	94	125.799	68.965	16.352	1.00	34.32	O
ATOM	710	CB	GLU	A	94	124.290	71.494	15.221	1.00	38.41	C
ATOM	711	CG	GLU	A	94	123.485	72.240	14.164	1.00	43.97	C
ATOM	712	CD	GLU	A	94	122.504	73.241	14.699	1.00	46.41	C
ATOM	713	OE1	GLU	A	94	122.889	74.140	15.485	1.00	49.20	O
ATOM	714	OE2	GLU	A	94	121.331	73.134	14.300	1.00	49.67	O
ATOM	715	N	ASN	A	95	127.387	70.118	15.239	1.00	33.02	N
ATOM	716	CA	ASN	A	95	128.479	69.543	16.012	1.00	32.01	C
ATOM	717	C	ASN	A	95	129.343	68.043	15.831	1.00	32.61	C
ATOM	718	O	ASN	A	95	128.609	67.259	16.747	1.00	33.70	O
ATOM	719	CB	ASN	A	95	128.372	69.913	17.492	1.00	30.02	C
ATOM	720	CG	ASN	A	95	128.838	71.321	17.770	1.00	29.11	C
ATOM	721	OD1	ASN	A	95	128.954	71.729	18.923	1.00	29.21	O
ATOM	722	ND2	ASN	A	95	129.111	72.078	16.709	1.00	29.45	N
ATOM	723	N	GLY	A	96	127.930	67.669	14.620	1.00	32.33	N
ATOM	724	CA	GLY	A	96	127.697	66.283	14.265	1.00	31.72	C
ATOM	725	C	GLY	A	96	128.798	65.309	14.592	1.00	31.80	C
ATOM	726	O	GLY	A	96	128.522	64.157	14.919	1.00	32.70	O
ATOM	727	N	VAL	A	97	130.044	65.759	14.494	1.00	30.80	N
ATOM	728	CA	VAL	A	97	131.176	64.893	14.779	1.00	29.44	C
ATOM	729	C	VAL	A	97	132.092	65.468	15.859	1.00	29.78	C
ATOM	730	O	VAL	A	97	133.265	65.111	15.944	1.00	29.29	O
ATOM	731	CB	VAL	A	97	131.988	64.591	13.483	1.00	29.17	C
ATOM	732	CG1	VAL	A	97	131.121	63.797	12.506	1.00	27.93	C
ATOM	733	CG2	VAL	A	97	132.467	65.888	12.836	1.00	27.87	C
ATOM	734	N	ILE	A	98	131.542	66.357	16.684	1.00	29.98	N
ATOM	735	CA	ILE	A	98	132.288	66.962	17.789	1.00	30.43	C
ATOM	736	C	ILE	A	98	132.855	65.806	18.637	1.00	29.83	C
ATOM	737	O	ILE	A	98	133.873	65.950	19.309	1.00	30.21	O
ATOM	738	CB	ILE	A	98	131.352	67.877	18.652	1.00	29.97	C
ATOM	739	CG1	ILE	A	98	132.152	68.633	19.712	1.00	29.73	C
ATOM	740	CG2	ILE	A	98	130.264	67.044	19.317	1.00	30.85	C
ATOM	741	CD1	ILE	A	98	133.036	69.704	19.171	1.00	27.65	C
ATOM	742	N	ILE	A	99	132.174	64.665	18.593	1.00	29.88	N
ATOM	743	CA	ILE	A	99	132.594	63.450	19.290	1.00	31.02	C
ATOM	744	C	ILE	A	99	132.126	62.306	18.397	1.00	32.81	C
ATOM	745	O	ILE	A	99	131.219	62.488	17.580	1.00	34.65	O
ATOM	746	CB	ILE	A	99	131.937	63.285	20.675	1.00	30.36	C
ATOM	747	CG1	ILE	A	99	130.431	63.074	20.522	1.00	29.67	C
ATOM	748	CG2	ILE	A	99	132.225	64.503	21.530	1.00	29.88	C
ATOM	749	CD1	ILE	A	99	129.736	62.684	21.811	1.00	29.26	C
ATOM	750	N	ASP	A	100	132.724	61.130	18.544	1.00	33.17	N
ATOM	751	CA	ASP	A	100	132.353	59.993	17.704	1.00	34.04	C
ATOM	752	C	ASP	A	100	132.387	60.391	16.234	1.00	33.78	C
ATOM	753	O	ASP	A	100	131.398	60.248	15.520	1.00	34.06	O
ATOM	754	CB	ASP	A	100	130.956	59.485	18.050	1.00	35.98	C
ATOM	755	CG	ASP	A	100	130.844	59.045	19.490	1.00	39.21	C
ATOM	756	OD1	ASP	A	100	131.737	58.305	19.952	1.00	41.93	O
ATOM	757	OD2	ASP	A	100	129.861	59.425	20.159	1.00	41.57	O
ATOM	758	N	PRO	A	101	133.532	60.909	15.767	1.00	33.06	N
ATOM	759	CA	PRO	A	101	133.697	61.334	14.377	1.00	33.37	C

TABLE 7-continued

ATOM	760	C	PRO	A	101	133.763	60.179	13.382	1.00	32.86	C
ATOM	761	O	PRO	A	101	133.952	59.031	13.763	1.00	33.47	O
ATOM	762	CB	PRO	A	101	135.007	62.112	14.438	1.00	33.67	C
ATOM	763	CG	PRO	A	101	135.786	61.284	15.427	1.00	32.82	C
ATOM	764	CD	PRO	A	101	134.765	61.193	16.526	1.00	32.08	C
ATOM	765	N	PHE	A	102	133.589	60.488	12.104	1.00	33.11	N
ATOM	766	CA	PHE	A	102	133.693	59.469	11.065	1.00	33.73	C
ATOM	767	C	PHE	A	102	135.160	59.479	10.692	1.00	33.47	C
ATOM	768	O	PHE	A	102	135.813	60.506	10.805	1.00	34.81	O
ATOM	769	CB	PHE	A	102	132.876	59.832	9.817	1.00	34.53	C
ATOM	770	CG	PHE	A	102	131.396	59.878	10.045	1.00	35.48	C
ATOM	771	CD1	PHE	A	102	130.703	58.738	10.431	1.00	35.76	C
ATOM	772	CD2	PHE	A	102	130.691	61.069	9.880	1.00	36.37	C
ATOM	773	CE1	PHE	A	102	129.325	58.787	10.652	1.00	37.70	C
ATOM	774	CE2	PHE	A	102	129.313	61.124	10.097	1.00	36.90	C
ATOM	775	CZ	PHE	A	102	128.632	59.982	10.483	1.00	36.80	C
ATOM	776	N	PHE	A	103	135.684	58.346	10.252	1.00	34.52	N
ATOM	777	CA	PHE	A	103	137.081	58.283	9.858	1.00	35.62	C
ATOM	778	C	PHE	A	103	137.394	57.001	9.104	1.00	36.66	C
ATOM	779	O	PHE	A	103	136.670	56.013	9.215	1.00	37.58	O
ATOM	780	CB	PHE	A	103	137.989	58.453	11.094	1.00	34.86	C
ATOM	781	CG	PHE	A	103	137.695	57.493	12.221	1.00	34.87	C
ATOM	782	CD1	PHE	A	103	138.125	56.168	12.167	1.00	34.75	C
ATOM	783	CD2	PHE	A	103	136.978	57.917	13.340	1.00	34.59	C
ATOM	784	CE1	PHE	A	103	137.846	55.281	13.213	1.00	34.04	C
ATOM	785	CE2	PHE	A	103	136.696	57.037	14.387	1.00	34.29	C
ATOM	786	CZ	PHE	A	103	137.130	55.720	14.322	1.00	33.77	C
ATOM	787	N	LEU	A	104	138.453	57.036	8.307	1.00	37.81	N
ATOM	788	CA	LEU	A	104	138.872	55.879	7.532	1.00	39.19	C
ATOM	789	C	LEU	A	104	140.378	55.799	7.650	1.00	40.33	C
ATOM	790	O	LEU	A	104	141.005	56.725	8.159	1.00	40.69	O
ATOM	791	CB	LEU	A	104	138.470	56.035	6.062	1.00	39.32	C
ATOM	792	CG	LEU	A	104	136.970	56.076	5.745	1.00	39.96	C
ATOM	793	CD1	LEU	A	104	136.769	56.381	4.278	1.00	40.31	C
ATOM	794	CD2	LEU	A	104	136.321	54.747	6.108	1.00	40.67	C
ATOM	795	N	THR	A	105	140.957	54.697	7.184	1.00	41.82	N
ATOM	796	CA	THR	A	105	142.402	54.502	7.249	1.00	42.36	C
ATOM	797	C	THR	A	105	143.017	54.739	5.880	1.00	43.67	C
ATOM	798	O	THR	A	105	142.305	54.885	4.892	1.00	42.24	O
ATOM	799	CB	THR	A	105	142.764	53.062	7.696	1.00	42.10	C
ATOM	800	OG1	THR	A	105	142.395	52.126	6.673	1.00	41.32	O
ATOM	801	CG2	THR	A	105	142.038	52.712	8.990	1.00	40.95	C
ATOM	802	N	PRO	A	106	144.354	54.802	5.810	1.00	45.85	N
ATOM	803	CA	PRO	A	106	145.017	55.018	4.521	1.00	48.15	C
ATOM	804	C	PRO	A	106	144.730	53.792	3.643	1.00	50.24	C
ATOM	805	O	PRO	A	106	144.611	53.881	2.419	1.00	50.39	O
ATOM	806	CB	PRO	A	106	146.493	55.109	4.920	1.00	47.46	C
ATOM	807	CG	PRO	A	106	146.422	55.617	6.356	1.00	46.60	C
ATOM	808	CD	PRO	A	106	145.364	54.693	6.876	1.00	45.95	C
ATOM	809	N	GLU	A	107	144.606	52.651	4.312	1.00	51.71	N
ATOM	810	CA	GLU	A	107	144.347	51.375	3.670	1.00	52.95	C
ATOM	811	C	GLU	A	107	143.116	51.449	2.777	1.00	52.83	C
ATOM	812	O	GLU	A	107	143.177	51.081	1.608	1.00	53.42	O
ATOM	813	CB	GLU	A	107	144.138	50.302	4.739	1.00	55.06	C
ATOM	814	CG	GLU	A	107	145.023	50.465	5.974	1.00	58.02	C
ATOM	815	CD	GLU	A	107	146.496	50.615	5.636	1.00	60.20	C
ATOM	816	OE1	GLU	A	107	146.863	51.634	5.009	1.00	61.69	O
ATOM	817	OE2	GLU	A	107	147.288	49.713	5.995	1.00	62.09	O
ATOM	818	N	HIS	A	108	142.003	51.919	3.339	1.00	52.97	N
ATOM	819	CA	HIS	A	108	140.736	52.045	2.611	1.00	52.34	C
ATOM	820	C	HIS	A	108	140.913	52.647	1.232	1.00	52.01	C
ATOM	821	O	HIS	A	108	141.923	53.284	0.942	1.00	52.35	O
ATOM	822	CB	HIS	A	108	139.745	52.907	3.398	1.00	52.32	C
ATOM	823	CG	HIS	A	108	139.233	52.257	4.642	1.00	52.17	C
ATOM	824	ND1	HIS	A	108	138.355	51.198	4.619	1.00	53.21	N
ATOM	825	CD2	HIS	A	108	139.495	52.498	5.947	1.00	52.86	C
ATOM	826	CE1	HIS	A	108	138.097	50.814	5.856	1.00	52.97	C
ATOM	827	NE2	HIS	A	108	138.778	51.587	6.681	1.00	52.99	N
ATOM	828	N	LYS	A	109	139.915	52.443	0.387	1.00	51.80	N
ATOM	829	CA	LYS	A	109	139.945	52.962	-0.967	1.00	52.18	C
ATOM	830	C	LYS	A	109	139.137	54.260	-1.038	1.00	52.51	C
ATOM	831	O	LYS	A	109	138.083	54.380	-0.409	1.00	52.67	O
ATOM	832	CB	LYS	A	109	139.370	51.922	-1.929	1.00	52.23	C
ATOM	833	N	VAL	A	110	139.637	55.233	-1.792	1.00	52.49	N
ATOM	834	CA	VAL	A	110	138.942	56.509	-1.938	1.00	52.35	C
ATOM	835	C	VAL	A	110	137.447	56.292	-2.190	1.00	52.34	C
ATOM	836	O	VAL	A	110	136.619	57.135	-1.838	1.00	52.26	O
ATOM	837	CB	VAL	A	110	139.572	57.355	-3.087	1.00	52.12	C
ATOM	838	CG1	VAL	A	110	139.815	56.494	-4.295	1.00	52.21	C

TABLE 7-continued

ATOM	839	CG2	VAL	A	110	138.655	58.499	-3.467	1.00	51.75	C
ATOM	840	N	SER	A	111	137.111	55.151	-2.785	1.00	52.59	N
ATOM	841	CA	SER	A	111	135.721	54.813	-3.079	1.00	52.79	C
ATOM	842	C	SER	A	111	134.908	54.753	-1.799	1.00	52.49	C
ATOM	843	O	SER	A	111	133.805	55.295	-1.729	1.00	52.98	O
ATOM	844	CB	SER	A	111	135.630	53.457	-3.785	1.00	52.72	C
ATOM	845	OG	SER	A	111	136.290	53.485	-5.035	1.00	54.78	O
ATOM	846	N	GLU	A	112	135.458	54.086	-0.789	1.00	51.81	N
ATOM	847	CA	GLU	A	112	134.776	53.944	0.488	1.00	51.26	C
ATOM	848	C	GLU	A	112	134.617	55.315	1.135	1.00	51.38	C
ATOM	849	O	GLU	A	112	133.658	55.563	1.861	1.00	50.07	O
ATOM	850	CB	GLU	A	112	135.565	52.990	1.391	1.00	50.74	C
ATOM	851	CG	GLU	A	112	135.912	51.665	0.706	1.00	50.40	C
ATOM	852	CD	GLU	A	112	136.572	50.652	1.633	1.00	51.24	C
ATOM	853	OE1	GLU	A	112	135.884	50.113	2.524	1.00	51.42	O
ATOM	854	OE2	GLU	A	112	137.786	50.399	1.476	1.00	51.68	O
ATOM	855	N	ALA	A	113	135.555	56.213	0.845	1.00	52.48	N
ATOM	856	CA	ALA	A	113	135.509	57.570	1.392	1.00	53.74	C
ATOM	857	C	ALA	A	113	134.348	58.346	0.769	1.00	53.99	C
ATOM	858	O	ALA	A	113	133.653	59.108	1.450	1.00	53.28	O
ATOM	859	CB	ALA	A	113	136.834	58.294	1.129	1.00	53.95	C
ATOM	860	N	GLU	A	114	134.148	58.157	-0.531	1.00	54.68	N
ATOM	861	CA	GLU	A	114	133.055	58.824	-1.221	1.00	55.97	C
ATOM	862	C	GLU	A	114	131.743	58.169	-0.781	1.00	56.86	C
ATOM	863	O	GLU	A	114	130.685	58.799	-0.811	1.00	56.32	O
ATOM	864	CB	GLU	A	114	133.228	58.705	-2.732	1.00	55.49	C
ATOM	865	N	GLU	A	115	131.813	56.904	-0.366	1.00	57.91	N
ATOM	866	CA	GLU	A	115	130.616	56.209	0.076	1.00	59.80	C
ATOM	867	C	GLU	A	115	130.052	56.916	1.293	1.00	60.45	C
ATOM	868	O	GLU	A	115	128.866	57.239	1.326	1.00	60.90	O
ATOM	869	CB	GLU	A	115	130.905	54.747	0.444	1.00	61.61	C
ATOM	870	CG	GLU	A	115	131.454	53.877	-0.683	1.00	63.71	C
ATOM	871	CD	GLU	A	115	131.451	52.391	-0.333	1.00	64.61	C
ATOM	872	OE1	GLU	A	115	131.959	52.023	0.753	1.00	64.98	O
ATOM	873	OE2	GLU	A	115	130.946	51.590	-1.152	1.00	65.96	O
ATOM	874	N	LEU	A	116	130.898	57.161	2.294	1.00	61.14	N
ATOM	875	CA	LEU	A	116	130.433	57.830	3.504	1.00	62.15	C
ATOM	876	C	LEU	A	116	130.306	59.343	3.372	1.00	62.60	C
ATOM	877	O	LEU	A	116	129.583	59.975	4.149	1.00	62.47	O
ATOM	878	CB	LEU	A	116	131.299	57.443	4.719	1.00	62.38	C
ATOM	879	CG	LEU	A	116	132.827	57.374	4.656	1.00	62.61	C
ATOM	880	CD1	LEU	A	116	133.375	58.712	4.232	1.00	64.03	C
ATOM	881	CD2	LEU	A	116	133.389	56.975	6.020	1.00	60.86	C
HETATM	882	N	MSE	A	117	130.988	59.929	2.388	1.00	63.07	N
HETATM	883	CA	MSE	A	117	130.877	61.368	2.176	1.00	63.64	C
HETATM	884	C	MSE	A	117	129.512	61.672	1.578	1.00	62.94	C
HETATM	885	O	MSE	A	117	128.967	62.754	1.770	1.00	63.05	O
HETATM	886	CB	MSE	A	117	131.948	61.892	1.218	1.00	65.51	C
HETATM	887	CG	MSE	A	117	133.350	61.990	1.775	1.00	68.03	C
HETATM	888	SE	MSE	A	117	134.418	62.891	0.609	1.00	71.39	SE
HETATM	889	CE	MSE	A	117	135.980	62.908	1.489	1.00	71.27	C
ATOM	890	N	GLN	A	118	128.967	60.715	0.837	1.00	62.33	N
ATOM	891	CA	GLN	A	118	127.666	60.904	0.216	1.00	62.54	C
ATOM	892	C	GLN	A	118	126.526	60.316	1.036	1.00	61.98	C
ATOM	893	O	GLN	A	118	125.375	60.725	0.884	1.00	61.93	O
ATOM	894	CB	GLN	A	118	127.664	60.341	-1.215	1.00	63.28	C
ATOM	895	CG	GLN	A	118	128.093	61.366	-2.289	1.00	65.32	C
ATOM	896	CD	GLN	A	118	129.504	61.938	-2.088	1.00	66.65	C
ATOM	897	OE1	GLN	A	118	129.903	62.898	-2.760	1.00	66.36	O
ATOM	898	NE2	GLN	A	118	130.266	61.340	-1.179	1.00	67.13	N
ATOM	899	N	ARG	A	119	126.843	59.371	1.915	1.00	61.19	N
ATOM	900	CA	ARG	A	119	125.819	58.770	2.762	1.00	60.86	C
ATOM	901	C	ARG	A	119	125.467	59.751	3.884	1.00	60.07	C
ATOM	902	O	ARG	A	119	124.294	59.993	4.159	1.00	60.05	O
ATOM	903	CB	ARG	A	119	126.322	57.458	3.373	1.00	61.79	C
ATOM	904	CG	ARG	A	119	125.271	56.709	4.188	1.00	63.14	C
ATOM	905	CD	ARG	A	119	125.850	55.496	4.928	1.00	64.66	C
ATOM	906	NE	ARG	A	119	126.606	54.585	4.064	1.00	66.88	N
ATOM	907	CZ	ARG	A	119	126.125	53.988	2.973	1.00	67.98	C
ATOM	908	NH1	ARG	A	119	124.870	54.195	2.584	1.00	68.24	N
ATOM	909	NH2	ARG	A	119	126.902	53.171	2.269	1.00	68.20	N
ATOM	910	N	TYR	A	120	126.491	60.318	4.520	1.00	58.88	N
ATOM	911	CA	TYR	A	120	126.284	61.257	5.618	1.00	57.61	C
ATOM	912	C	TYR	A	120	126.450	62.692	5.172	1.00	57.09	C
ATOM	913	O	TYR	A	120	126.409	63.612	5.989	1.00	57.12	O
ATOM	914	CB	TYR	A	120	127.257	60.974	6.766	1.00	57.42	C
ATOM	915	CG	TYR	A	120	127.192	59.552	7.269	1.00	57.82	C
ATOM	916	CD1	TYR	A	120	127.890	58.529	6.623	1.00	57.64	C
ATOM	917	CD2	TYR	A	120	126.365	59.214	8.337	1.00	57.74	C

TABLE 7-continued

ATOM	918	CE1	TYR	A	120	127.760	57.207	7.028	1.00	57.96	C
ATOM	919	CE2	TYR	A	120	126.226	57.895	8.748	1.00	58.11	C
ATOM	920	CZ	TYR	A	120	126.923	56.897	8.091	1.00	58.31	C
ATOM	921	OH	TYR	A	120	126.772	55.590	8.496	1.00	58.89	O
ATOM	922	N	ARG	A	121	126.638	62.875	3.872	1.00	56.83	N
ATOM	923	CA	ARG	A	121	126.818	64.200	3.293	1.00	56.77	C
ATOM	924	C	ARG	A	121	127.838	65.035	4.069	1.00	56.25	C
ATOM	925	O	ARG	A	121	127.479	65.797	4.966	1.00	56.28	O
ATOM	926	CB	ARG	A	121	125.486	64.927	3.233	1.00	57.20	C
ATOM	927	N	ILE	A	122	129.110	64.875	3.715	1.00	56.16	N
ATOM	928	CA	ILE	A	122	130.198	65.608	4.349	1.00	55.55	C
ATOM	929	C	ILE	A	122	131.305	65.938	3.339	1.00	55.54	C
ATOM	930	O	ILE	A	122	131.590	65.158	2.418	1.00	54.76	O
ATOM	931	CB	ILE	A	122	130.793	64.811	5.536	1.00	55.74	C
ATOM	932	CG1	ILE	A	122	131.116	63.377	5.094	1.00	55.80	C
ATOM	933	CG2	ILE	A	122	129.830	64.836	6.717	1.00	54.89	C
ATOM	934	CD1	ILE	A	122	131.738	62.510	6.186	1.00	55.41	C
ATOM	935	N	SER	A	123	131.915	67.106	3.535	1.00	54.93	N
ATOM	936	CA	SER	A	123	132.984	67.625	2.681	1.00	54.06	C
ATOM	937	C	SER	A	123	134.342	66.963	2.907	1.00	52.28	C
ATOM	938	O	SER	A	123	135.218	67.017	2.037	1.00	51.82	O
ATOM	939	CB	SER	A	123	133.121	69.139	2.902	1.00	55.93	C
ATOM	940	OG	SER	A	123	134.227	69.683	2.192	1.00	58.65	O
ATOM	941	N	GLY	A	124	134.516	66.353	4.077	1.00	50.22	N
ATOM	942	CA	GLY	A	124	135.780	65.706	4.383	1.00	47.42	C
ATOM	943	C	GLY	A	124	135.668	64.500	5.297	1.00	45.07	C
ATOM	944	O	GLY	A	124	134.709	64.357	6.055	1.00	44.24	O
ATOM	945	N	VAL	A	125	136.674	63.634	5.222	1.00	43.19	N
ATOM	946	CA	VAL	A	125	136.728	62.421	6.031	1.00	40.55	C
ATOM	947	C	VAL	A	125	138.068	62.319	6.761	1.00	38.76	C
ATOM	948	O	VAL	A	125	139.108	62.120	6.127	1.00	38.57	O
ATOM	949	CB	VAL	A	125	136.569	61.164	5.143	1.00	40.66	C
ATOM	950	CG1	VAL	A	125	136.596	59.900	5.994	1.00	38.37	C
ATOM	951	CG2	VAL	A	125	135.287	61.260	4.349	1.00	40.81	C
ATOM	952	N	PRO	A	126	138.066	62.478	8.101	1.00	36.88	N
ATOM	953	CA	PRO	A	126	139.315	62.379	8.853	1.00	35.19	C
ATOM	954	C	PRO	A	126	139.932	61.024	8.545	1.00	35.43	C
ATOM	955	O	PRO	A	126	139.225	60.021	8.465	1.00	35.78	O
ATOM	956	CB	PRO	A	126	138.837	62.486	10.296	1.00	34.50	C
ATOM	957	CG	PRO	A	126	137.674	63.417	10.171	1.00	34.23	C
ATOM	958	CD	PRO	A	126	136.951	62.747	9.026	1.00	35.70	C
ATOM	959	N	ILE	A	127	141.244	60.993	8.351	1.00	35.94	N
ATOM	960	CA	ILE	A	127	141.934	59.741	8.048	1.00	35.44	C
ATOM	961	C	ILE	A	127	142.914	59.398	9.158	1.00	34.68	C
ATOM	962	O	ILE	A	127	143.803	60.183	9.481	1.00	34.35	O
ATOM	963	CB	ILE	A	127	142.673	59.831	6.687	1.00	35.26	C
ATOM	964	CG1	ILE	A	127	141.653	60.068	5.574	1.00	33.84	C
ATOM	965	CG2	ILE	A	127	143.454	58.559	6.420	1.00	34.74	C
ATOM	966	CD1	ILE	A	127	140.587	59.008	5.506	1.00	32.76	C
ATOM	967	N	VAL	A	128	142.733	58.220	9.744	1.00	35.29	N
ATOM	968	CA	VAL	A	128	143.577	57.769	10.842	1.00	35.15	C
ATOM	969	C	VAL	A	128	144.430	56.582	10.430	1.00	36.25	C
ATOM	970	O	VAL	A	128	144.079	55.831	9.522	1.00	35.92	O
ATOM	971	CB	VAL	A	128	142.721	57.391	12.065	1.00	34.44	C
ATOM	972	CG1	VAL	A	128	141.877	58.590	12.486	1.00	33.76	C
ATOM	973	CG2	VAL	A	128	141.820	56.211	11.732	1.00	34.06	C
ATOM	974	N	GLU	A	129	145.556	56.416	11.106	1.00	37.38	N
ATOM	975	CA	GLU	A	129	146.467	55.332	10.798	1.00	39.94	C
ATOM	976	C	GLU	A	129	145.759	53.984	10.909	1.00	40.56	C
ATOM	977	O	GLU	A	129	145.765	53.196	9.967	1.00	41.74	O
ATOM	978	CB	GLU	A	129	147.666	55.398	11.743	1.00	42.72	C
ATOM	979	CG	GLU	A	129	148.817	54.478	11.383	1.00	46.98	C
ATOM	980	CD	GLU	A	129	150.030	54.715	12.260	1.00	48.82	C
ATOM	981	OE1	GLU	A	129	151.062	54.051	12.044	1.00	51.32	O
ATOM	982	OE2	GLU	A	129	149.952	55.568	13.165	1.00	50.14	O
ATOM	983	N	THR	A	130	145.138	53.733	12.057	1.00	41.09	N
ATOM	984	CA	THR	A	130	144.414	52.487	12.309	1.00	41.55	C
ATOM	985	C	THR	A	130	143.047	52.806	12.908	1.00	42.57	C
ATOM	986	O	THR	A	130	142.936	53.676	13.769	1.00	42.54	O
ATOM	987	CB	THR	A	130	145.185	51.596	13.311	1.00	41.31	C
ATOM	988	OG1	THR	A	130	146.399	51.125	12.716	1.00	42.29	O
ATOM	989	CG2	THR	A	130	144.359	50.423	13.721	1.00	42.50	C
ATOM	990	N	LEU	A	131	142.004	52.115	12.459	1.00	43.48	N
ATOM	991	CA	LEU	A	131	140.673	52.358	13.010	1.00	44.46	C
ATOM	992	C	LEU	A	131	140.687	52.246	14.537	1.00	45.25	C
ATOM	993	O	LEU	A	131	139.931	52.937	15.223	1.00	45.86	O
ATOM	994	CB	LEU	A	131	139.653	51.354	12.463	1.00	43.91	C
ATOM	995	CG	LEU	A	131	139.245	51.387	10.993	1.00	44.06	C
ATOM	996	CD1	LEU	A	131	138.161	50.346	10.768	1.00	43.41	C

TABLE 7-continued

ATOM	997	CD2	LEU	A	131	138.724	52.767	10.616	1.00	43.19	C
ATOM	998	N	ALA	A	132	141.547	51.370	15.058	1.00	45.26	N
ATOM	999	CA	ALA	A	132	141.662	51.144	16.497	1.00	45.23	C
ATOM	1000	C	ALA	A	132	142.550	52.169	17.192	1.00	45.48	C
ATOM	1001	O	ALA	A	132	142.308	52.513	18.350	1.00	45.96	O
ATOM	1002	CB	ALA	A	132	142.194	49.742	16.757	1.00	45.56	C
ATOM	1003	N	ASN	A	133	143.576	52.647	16.490	1.00	45.46	N
ATOM	1004	CA	ASN	A	133	144.501	53.631	17.046	1.00	45.65	C
ATOM	1005	C	ASN	A	133	143.949	55.048	16.975	1.00	43.65	C
ATOM	1006	O	ASN	A	133	144.187	55.858	17.869	1.00	42.55	O
ATOM	1007	CB	ASN	A	133	145.843	53.574	16.311	1.00	49.92	C
ATOM	1008	CG	ASN	A	133	146.520	52.219	16.448	1.00	56.12	C
ATOM	1009	OD1	ASN	A	133	146.006	51.203	15.966	1.00	58.65	O
ATOM	1010	ND2	ASN	A	133	147.675	52.191	17.123	1.00	58.07	N
ATOM	1011	N	ARG	A	134	143.216	55.339	15.907	1.00	40.92	N
ATOM	1012	CA	ARG	A	134	142.625	56.658	15.695	1.00	39.45	C
ATOM	1013	C	ARG	A	134	143.613	57.821	15.694	1.00	38.37	C
ATOM	1014	O	ARG	A	134	143.246	58.957	15.992	1.00	36.45	O
ATOM	1015	CB	ARG	A	134	141.497	56.900	16.709	1.00	38.26	C
ATOM	1016	CG	ARG	A	134	140.300	56.027	16.404	1.00	38.05	C
ATOM	1017	CD	ARG	A	134	139.161	56.142	17.384	1.00	38.82	C
ATOM	1018	NE	ARG	A	134	138.665	57.501	17.541	1.00	39.64	N
ATOM	1019	CZ	ARG	A	134	137.458	57.789	18.023	1.00	41.06	C
ATOM	1020	NH1	ARG	A	134	136.635	56.808	18.381	1.00	41.95	N
ATOM	1021	NH2	ARG	A	134	137.079	59.052	18.177	1.00	40.31	N
ATOM	1022	N	LYS	A	135	144.861	57.532	15.335	1.00	38.36	N
ATOM	1023	CA	LYS	A	135	145.888	58.562	15.277	1.00	38.55	C
ATOM	1024	C	LYS	A	135	145.654	59.286	13.962	1.00	38.13	C
ATOM	1025	O	LYS	A	135	145.719	58.689	12.888	1.00	38.05	O
ATOM	1026	CB	LYS	A	135	147.286	57.944	15.286	1.00	40.56	C
ATOM	1027	CG	LYS	A	135	148.357	58.915	15.766	1.00	44.66	C
ATOM	1028	CD	LYS	A	135	149.768	58.434	15.482	1.00	46.81	C
ATOM	1029	CE	LYS	A	135	150.058	58.514	13.995	1.00	48.72	C
ATOM	1030	NZ	LYS	A	135	151.483	58.202	13.692	1.00	51.64	N
ATOM	1031	N	LEU	A	136	145.372	60.577	14.041	1.00	37.97	N
ATOM	1032	CA	LEU	A	136	145.083	61.351	12.842	1.00	37.65	C
ATOM	1033	C	LEU	A	136	146.305	61.414	11.939	1.00	37.71	C
ATOM	1034	O	LEU	A	136	147.377	61.816	12.375	1.00	37.36	O
ATOM	1035	CB	LEU	A	136	144.675	62.772	13.222	1.00	36.41	C
ATOM	1036	CG	LEU	A	136	143.745	63.524	12.278	1.00	36.38	C
ATOM	1037	CD1	LEU	A	136	143.847	64.993	12.619	1.00	37.47	C
ATOM	1038	CD2	LEU	A	136	144.126	63.310	10.839	1.00	37.55	C
ATOM	1039	N	VAL	A	137	146.153	61.015	10.684	1.00	37.97	N
ATOM	1040	CA	VAL	A	137	147.270	61.082	9.755	1.00	38.94	C
ATOM	1041	C	VAL	A	137	146.934	62.066	8.654	1.00	39.72	C
ATOM	1042	O	VAL	A	137	147.820	62.555	7.953	1.00	41.11	O
ATOM	1043	CB	VAL	A	137	147.599	59.708	9.131	1.00	39.02	C
ATOM	1044	CG1	VAL	A	137	148.108	58.761	10.207	1.00	39.27	C
ATOM	1045	CG2	VAL	A	137	146.369	59.134	8.452	1.00	39.34	C
ATOM	1046	N	GLY	A	138	145.647	62.366	8.510	1.00	39.89	N
ATOM	1047	CA	GLY	A	138	145.225	63.305	7.487	1.00	40.00	C
ATOM	1048	C	GLY	A	138	143.723	63.410	7.327	1.00	40.02	C
ATOM	1049	O	GLY	A	138	142.964	62.994	8.197	1.00	39.08	O
ATOM	1050	N	ILE	A	139	143.292	63.972	6.208	1.00	40.37	N
ATOM	1051	CA	ILE	A	139	141.873	64.123	5.951	1.00	42.42	C
ATOM	1052	C	ILE	A	139	141.619	64.260	4.462	1.00	44.67	C
ATOM	1053	O	ILE	A	139	142.292	65.033	3.784	1.00	47.01	O
ATOM	1054	CB	ILE	A	139	141.318	65.358	6.674	1.00	40.67	C
ATOM	1055	CG1	ILE	A	139	139.861	65.581	6.289	1.00	39.76	C
ATOM	1056	CG2	ILE	A	139	142.149	66.568	6.332	1.00	41.34	C
ATOM	1057	CD1	ILE	A	139	139.218	66.707	7.054	1.00	39.54	C
ATOM	1058	N	ILE	A	140	140.656	63.504	3.946	1.00	46.05	N
ATOM	1059	CA	ILE	A	140	140.339	63.579	2.524	1.00	46.92	C
ATOM	1060	C	ILE	A	140	139.150	64.519	2.348	1.00	47.17	C
ATOM	1061	O	ILE	A	140	138.198	64.483	3.133	1.00	46.73	O
ATOM	1062	CB	ILE	A	140	140.011	62.179	1.944	1.00	47.40	C
ATOM	1063	CG1	ILE	A	140	139.843	62.274	0.430	1.00	48.09	C
ATOM	1064	CG2	ILE	A	140	138.739	61.622	2.572	1.00	46.23	C
ATOM	1065	CD1	ILE	A	140	139.614	60.936	-0.222	1.00	49.16	C
ATOM	1066	N	THR	A	141	139.221	65.379	1.334	1.00	48.17	N
ATOM	1067	CA	THR	A	141	138.152	66.343	1.072	1.00	49.05	C
ATOM	1068	C	THR	A	141	137.655	66.341	-0.379	1.00	50.14	C
ATOM	1069	O	THR	A	141	138.275	65.739	-1.259	1.00	49.18	O
ATOM	1070	CB	THR	A	141	138.606	67.774	1.423	1.00	47.83	C
ATOM	1071	OG1	THR	A	141	139.757	68.119	0.640	1.00	46.02	O
ATOM	1072	CG2	THR	A	141	138.942	67.872	2.899	1.00	47.21	C
ATOM	1073	N	ASN	A	142	136.528	67.021	-0.608	1.00	51.50	N
ATOM	1074	CA	ASN	A	142	135.933	67.126	-1.939	1.00	52.02	C
ATOM	1075	C	ASN	A	142	137.001	67.465	-2.969	1.00	52.18	C

TABLE 7-continued

ATOM	1076	O	ASN	A	142	137.129	66.788	-3.996	1.00	51.47	O
ATOM	1077	CB	ASN	A	142	134.855	68.212	-1.971	1.00	52.46	C
ATOM	1078	CG	ASN	A	142	133.687	67.903	-1.070	1.00	53.06	C
ATOM	1079	OD1	ASN	A	142	133.150	66.803	-1.098	1.00	53.57	O
ATOM	1080	ND2	ASN	A	142	133.269	66.884	-0.279	1.00	53.81	N
ATOM	1081	N	ARG	A	143	137.756	68.525	-2.692	1.00	52.54	N
ATOM	1082	CA	ARG	A	143	138.825	68.951	-3.584	1.00	54.02	C
ATOM	1083	C	ARG	A	143	139.664	67.726	-3.944	1.00	54.83	C
ATOM	1084	O	ARG	A	143	140.061	67.543	-5.096	1.00	54.60	O
ATOM	1085	CB	ARG	A	143	139.695	70.014	-2.902	1.00	53.82	C
ATOM	1086	N	ASP	A	144	139.915	66.883	-2.949	1.00	55.80	N
ATOM	1087	CA	ASP	A	144	140.700	65.677	-3.152	1.00	56.78	C
ATOM	1088	C	ASP	A	144	139.969	64.713	-4.074	1.00	56.65	C
ATOM	1089	O	ASP	A	144	140.574	64.119	-4.959	1.00	56.82	O
ATOM	1090	CB	ASP	A	144	140.969	64.991	-1.812	1.00	58.80	C
ATOM	1091	CG	ASP	A	144	141.647	65.910	-0.810	1.00	61.29	C
ATOM	1092	OD1	ASP	A	144	141.895	65.471	0.337	1.00	61.86	O
ATOM	1093	OD2	ASP	A	144	141.931	67.075	-1.171	1.00	63.17	O
HETATM	1094	N	MSE	A	145	138.667	64.562	-3.870	1.00	56.83	N
HETATM	1095	CA	MSE	A	145	137.880	63.639	-4.682	1.00	57.70	C
HETATM	1096	C	MSE	A	145	137.785	64.062	-6.151	1.00	57.60	C
HETATM	1097	O	MSE	A	145	137.748	63.206	-7.041	1.00	57.31	O
HETATM	1098	CB	MSE	A	145	136.471	63.475	-4.085	1.00	59.38	C
HETATM	1099	CG	MSE	A	145	136.437	62.951	-2.630	1.00	60.94	C
HETATM	1100	SE	MSE	A	145	137.129	61.269	-2.351	1.00	62.97	SE
HETATM	1101	CE	MSE	A	145	135.969	60.258	-3.296	1.00	61.65	C
ATOM	1102	N	ARG	A	146	137.750	65.371	-6.407	1.00	57.09	N
ATOM	1103	CA	ARG	A	146	137.664	65.877	-7.782	1.00	56.31	C
ATOM	1104	C	ARG	A	146	138.988	65.762	-8.528	1.00	56.60	C
ATOM	1105	O	ARG	A	146	139.012	65.623	-9.750	1.00	56.62	O
ATOM	1106	CB	ARG	A	146	137.156	67.326	-7.793	1.00	54.46	C
ATOM	1107	CG	ARG	A	146	135.700	67.413	-7.370	1.00	53.47	C
ATOM	1108	CD	ARG	A	146	135.118	68.816	-7.389	1.00	52.51	C
ATOM	1109	NE	ARG	A	146	135.796	69.724	-6.471	1.00	51.48	N
ATOM	1110	CZ	ARG	A	146	135.178	70.651	-5.747	1.00	50.40	C
ATOM	1111	NH1	ARG	A	146	135.878	71.435	-4.942	1.00	50.47	N
ATOM	1112	NH2	ARG	A	146	133.858	70.774	-5.804	1.00	49.06	N
ATOM	1113	N	PHE	A	147	140.087	65.813	-7.787	1.00	57.55	N
ATOM	1114	CA	PHE	A	147	141.414	65.682	-8.375	1.00	58.70	C
ATOM	1115	C	PHE	A	147	141.641	64.221	-8.736	1.00	59.46	C
ATOM	1116	O	PHE	A	147	142.318	63.911	-9.718	1.00	58.95	O
ATOM	1117	CB	PHE	A	147	142.485	66.148	-7.377	1.00	58.89	C
ATOM	1118	CG	PHE	A	147	143.894	65.843	-7.807	1.00	59.83	C
ATOM	1119	CD1	PHE	A	147	144.369	64.530	-7.822	1.00	60.00	C
ATOM	1120	CD2	PHE	A	147	144.741	66.865	-8.228	1.00	60.66	C
ATOM	1121	CE1	PHE	A	147	145.662	64.238	-8.252	1.00	60.08	C
ATOM	1122	CE2	PHE	A	147	146.040	66.587	-8.661	1.00	60.69	C
ATOM	1123	CZ	PHE	A	147	146.500	65.268	-8.673	1.00	60.63	C
ATOM	1124	N	ILE	A	148	141.062	63.335	-7.928	1.00	60.40	N
ATOM	1125	CA	ILE	A	148	141.187	61.889	-8.103	1.00	62.00	C
ATOM	1126	C	ILE	A	148	140.398	61.335	-9.291	1.00	63.07	C
ATOM	1127	O	ILE	A	148	139.203	61.593	-9.441	1.00	62.54	O
ATOM	1128	CB	ILE	A	148	140.735	61.148	-6.823	1.00	61.84	C
ATOM	1129	CG1	ILE	A	148	141.583	61.602	-5.640	1.00	60.88	C
ATOM	1130	CG2	ILE	A	148	140.870	59.641	-7.006	1.00	61.40	C
ATOM	1131	CD1	ILE	A	148	141.125	61.022	-4.335	1.00	61.89	C
ATOM	1132	N	SER	A	149	141.083	60.554	-10.120	1.00	65.13	N
ATOM	1133	CA	SER	A	149	140.476	59.958	-11.299	1.00	67.10	C
ATOM	1134	C	SER	A	149	139.843	58.606	-10.999	1.00	68.06	C
ATOM	1135	O	SER	A	149	138.637	58.434	-11.177	1.00	68.25	O
ATOM	1136	CB	SER	A	149	141.522	59.797	-12.399	1.00	67.81	C
ATOM	1137	OG	SER	A	149	140.952	59.177	-13.539	1.00	70.51	O
ATOM	1138	N	ASP	A	150	140.655	57.649	-10.552	1.00	68.94	N
ATOM	1139	CA	ASP	A	150	140.150	56.315	-10.231	1.00	70.14	C
ATOM	1140	C	ASP	A	150	139.976	56.065	-8.731	1.00	70.46	C
ATOM	1141	O	ASP	A	150	140.951	56.007	-7.976	1.00	69.92	O
ATOM	1142	CB	ASP	A	150	141.060	55.240	-10.832	1.00	70.63	C
ATOM	1143	CG	ASP	A	150	140.627	53.834	-10.454	1.00	71.26	C
ATOM	1144	OD1	ASP	A	150	140.813	53.447	-9.281	1.00	71.97	O
ATOM	1145	OD2	ASP	A	150	140.084	53.120	-11.323	1.00	71.75	O
ATOM	1146	N	TYR	A	151	138.720	55.901	-8.320	1.00	71.24	N
ATOM	1147	CA	TYR	A	151	138.374	55.667	-6.924	1.00	72.22	C
ATOM	1148	C	TYR	A	151	138.715	54.281	-6.383	1.00	73.14	C
ATOM	1149	O	TYR	A	151	138.725	54.073	-5.173	1.00	73.06	O
ATOM	1150	CB	TYR	A	151	136.886	55.953	-6.698	1.00	71.67	C
ATOM	1151	CG	TYR	A	151	136.524	57.422	-6.784	1.00	72.11	C
ATOM	1152	CD1	TYR	A	151	135.227	57.860	-6.503	1.00	71.81	C
ATOM	1153	CD2	TYR	A	151	137.484	58.383	-7.117	1.00	72.04	C
ATOM	1154	CE1	TYR	A	151	134.896	59.218	-6.548	1.00	71.71	C

TABLE 7-continued

ATOM	1155	CE2	TYR	A	151	137.165	59.740	-7.165	1.00	71.99	C
ATOM	1156	CZ	TYR	A	151	135.872	60.151	-6.880	1.00	72.05	C
ATOM	1157	OH	TYR	A	151	135.558	61.492	-6.927	1.00	72.25	O
ATOM	1158	N	ASN	A	152	138.995	53.334	-7.270	1.00	74.39	N
ATOM	1159	CA	ASN	A	152	139.336	51.982	-6.841	1.00	75.27	C
ATOM	1160	C	ASN	A	152	140.814	51.937	-6.437	1.00	75.50	C
ATOM	1161	O	ASN	A	152	141.587	51.113	-6.932	1.00	75.85	O
ATOM	1162	CB	ASN	A	152	139.064	50.987	-7.976	1.00	75.63	C
ATOM	1163	CG	ASN	A	152	139.219	49.539	-7.539	1.00	76.28	C
ATOM	1164	OD1	ASN	A	152	139.084	48.620	-8.350	1.00	77.14	O
ATOM	1165	ND2	ASN	A	152	139.497	49.329	-6.254	1.00	76.29	N
ATOM	1166	N	ALA	A	153	141.199	52.834	-5.536	1.00	75.52	N
ATOM	1167	CA	ALA	A	153	142.578	52.906	-5.067	1.00	75.70	C
ATOM	1168	C	ALA	A	153	142.649	53.360	-3.609	1.00	76.00	C
ATOM	1169	O	ALA	A	153	141.778	54.093	-3.133	1.00	75.58	O
ATOM	1170	CB	ALA	A	153	143.375	53.864	-5.951	1.00	75.45	C
ATOM	1171	N	PRO	A	154	143.696	52.929	-2.880	1.00	76.38	N
ATOM	1172	CA	PRO	A	154	143.883	53.294	-1.474	1.00	76.60	C
ATOM	1173	C	PRO	A	154	143.829	54.809	-1.297	1.00	76.99	C
ATOM	1174	O	PRO	A	154	144.532	55.552	-1.984	1.00	76.89	O
ATOM	1175	CB	PRO	A	154	145.258	52.707	-1.164	1.00	76.34	C
ATOM	1176	CG	PRO	A	154	145.247	51.457	-2.012	1.00	75.98	C
ATOM	1177	CD	PRO	A	154	144.813	52.076	-3.321	1.00	76.29	C
ATOM	1178	N	ILE	A	155	142.988	55.258	-0.372	1.00	77.55	N
ATOM	1179	CA	ILE	A	155	142.818	56.681	-0.114	1.00	78.03	C
ATOM	1180	C	ILE	A	155	144.150	57.341	0.208	1.00	78.39	C
ATOM	1181	O	ILE	A	155	144.232	58.559	0.337	1.00	78.68	O
ATOM	1182	CB	ILE	A	155	141.834	56.914	1.050	1.00	77.70	C
ATOM	1183	CG1	ILE	A	155	141.484	58.397	1.151	1.00	78.19	C
ATOM	1184	CG2	ILE	A	155	142.450	56.433	2.349	1.00	77.56	C
ATOM	1185	CD1	ILE	A	155	140.407	58.690	2.160	1.00	78.30	C
ATOM	1186	N	SER	A	156	145.190	56.523	0.330	1.00	79.20	N
ATOM	1187	CA	SER	A	156	146.534	57.002	0.631	1.00	80.33	C
ATOM	1188	C	SER	A	156	147.172	57.678	-0.584	1.00	81.04	C
ATOM	1189	O	SER	A	156	147.530	58.859	-0.535	1.00	81.05	O
ATOM	1190	CB	SER	A	156	147.408	55.828	1.079	1.00	80.24	C
ATOM	1191	OG	SER	A	156	148.735	56.249	1.337	1.00	80.63	O
ATOM	1192	N	GLU	A	157	147.308	56.914	-1.667	1.00	81.98	N
ATOM	1193	CA	GLU	A	157	147.904	57.392	-2.913	1.00	82.66	C
ATOM	1194	C	GLU	A	157	147.458	58.803	-3.271	1.00	83.46	C
ATOM	1195	O	GLU	A	157	148.228	59.588	-3.821	1.00	84.07	O
ATOM	1196	CB	GLU	A	157	147.556	56.426	-4.047	1.00	82.38	C
ATOM	1197	CG	GLU	A	157	148.089	55.022	-3.808	1.00	82.83	C
ATOM	1198	CD	GLU	A	157	147.657	54.028	-4.865	1.00	83.03	C
ATOM	1199	OE1	GLU	A	157	148.095	52.857	-4.790	1.00	82.84	O
ATOM	1200	OE2	GLU	A	157	146.877	54.415	-5.763	1.00	83.32	O
ATOM	1201	N	HIS	A	158	146.209	59.117	-2.952	1.00	84.27	N
ATOM	1202	CA	HIS	A	158	145.643	60.434	-3.219	1.00	84.85	C
ATOM	1203	C	HIS	A	158	145.351	60.997	-1.845	1.00	84.86	C
ATOM	1204	O	HIS	A	158	144.307	60.702	-1.263	1.00	84.99	O
ATOM	1205	CB	HIS	A	158	144.344	60.285	-4.004	1.00	85.54	C
ATOM	1206	CG	HIS	A	158	144.473	59.414	-5.212	1.00	86.62	C
ATOM	1207	ND1	HIS	A	158	145.274	59.744	-6.284	1.00	87.28	N
ATOM	1208	CD2	HIS	A	158	143.939	58.204	-5.499	1.00	87.21	C
ATOM	1209	CE1	HIS	A	158	145.227	58.773	-7.180	1.00	87.78	C
ATOM	1210	NE2	HIS	A	158	144.424	57.828	-6.727	1.00	87.86	N
HETATM	1211	N	MSE	A	159	146.256	61.812	-1.319	1.00	84.93	N
HETATM	1212	CA	MSE	A	159	146.042	62.323	0.020	1.00	85.49	C
HETATM	1213	C	MSE	A	159	146.301	63.765	0.395	1.00	84.25	C
HETATM	1214	O	MSE	A	159	146.445	64.646	-0.450	1.00	84.36	O
HETATM	1215	CB	MSE	A	159	146.789	61.430	0.998	1.00	87.98	C
HETATM	1216	CG	MSE	A	159	145.862	60.499	1.708	1.00	91.79	C
HETATM	1217	SE	MSE	A	159	144.854	61.381	2.951	1.00	96.88	SE
HETATM	1218	CE	MSE	A	159	143.842	60.037	3.500	1.00	95.69	C
ATOM	1219	N	THR	A	160	146.334	63.979	1.707	1.00	82.42	N
ATOM	1220	CA	THR	A	160	146.554	65.285	2.294	1.00	80.55	C
ATOM	1221	C	THR	A	160	147.496	65.164	3.494	1.00	79.27	C
ATOM	1222	O	THR	A	160	147.094	65.408	4.636	1.00	79.55	O
ATOM	1223	CB	THR	A	160	145.220	65.902	2.763	1.00	80.73	C
ATOM	1224	OG1	THR	A	160	144.314	65.984	1.655	1.00	80.34	O
ATOM	1225	CG2	THR	A	160	145.444	67.296	3.327	1.00	80.81	C
ATOM	1226	N	SER	A	161	148.740	64.758	3.238	1.00	77.07	N
ATOM	1227	CA	SER	A	161	149.739	64.647	4.304	1.00	74.22	C
ATOM	1228	C	SER	A	161	150.444	65.995	4.396	1.00	72.09	C
ATOM	1229	O	SER	A	161	151.661	66.101	4.203	1.00	72.10	O
ATOM	1230	CB	SER	A	161	150.761	63.542	4.005	1.00	74.18	C
ATOM	1231	OG	SER	A	161	150.194	62.254	4.160	1.00	73.46	O
ATOM	1232	N	GLU	A	162	149.649	67.023	4.678	1.00	68.49	N
ATOM	1233	CA	GLU	A	162	150.138	68.386	4.802	1.00	63.99	C

TABLE 7-continued

ATOM	1234	C	GLU	A	162	150.457	68.572	6.275	1.00	59.31	C
ATOM	1235	O	GLU	A	162	150.507	67.606	7.030	1.00	59.06	O
ATOM	1236	CB	GLU	A	162	149.045	69.372	4.378	1.00	66.51	C
ATOM	1237	CG	GLU	A	162	148.309	68.983	3.088	1.00	69.52	C
ATOM	1238	CD	GLU	A	162	149.171	69.063	1.834	1.00	71.43	C
ATOM	1239	OE1	GLU	A	162	148.736	68.542	0.781	1.00	72.92	O
ATOM	1240	OE2	GLU	A	162	150.266	69.661	1.890	1.00	72.32	O
ATOM	1241	N	HIS	A	163	150.673	69.812	6.683	1.00	53.68	N
ATOM	1242	CA	HIS	A	163	150.977	70.095	8.075	1.00	48.20	C
ATOM	1243	C	HIS	A	163	149.629	70.167	8.775	1.00	45.82	C
ATOM	1244	O	HIS	A	163	148.922	71.167	8.680	1.00	46.57	O
ATOM	1245	CB	HIS	A	163	151.724	71.430	8.187	1.00	45.00	C
ATOM	1246	CG	HIS	A	163	152.253	71.721	9.555	1.00	40.59	C
ATOM	1247	ND1	HIS	A	163	153.047	70.833	10.249	1.00	38.53	N
ATOM	1248	CD2	HIS	A	163	152.151	72.822	10.335	1.00	38.60	C
ATOM	1249	CE1	HIS	A	163	153.412	71.374	11.396	1.00	37.85	C
ATOM	1250	NE2	HIS	A	163	152.883	72.582	11.472	1.00	38.90	N
ATOM	1251	N	LEU	A	164	149.271	69.096	9.467	1.00	42.78	N
ATOM	1252	CA	LEU	A	164	147.990	69.033	10.156	1.00	39.51	C
ATOM	1253	C	LEU	A	164	147.812	70.110	11.218	1.00	36.83	C
ATOM	1254	O	LEU	A	164	148.676	70.312	12.068	1.00	36.48	O
ATOM	1255	CB	LEU	A	164	147.800	67.641	10.781	1.00	39.26	C
ATOM	1256	CG	LEU	A	164	147.792	66.468	9.789	1.00	39.23	C
ATOM	1257	CD1	LEU	A	164	147.637	65.153	10.537	1.00	39.06	C
ATOM	1258	CD2	LEU	A	164	146.665	66.650	8.788	1.00	38.45	C
ATOM	1259	N	VAL	A	165	146.689	70.817	11.139	1.00	33.58	N
ATOM	1260	CA	VAL	A	165	146.356	71.858	12.103	1.00	30.38	C
ATOM	1261	C	VAL	A	165	145.268	71.266	12.996	1.00	29.08	C
ATOM	1262	O	VAL	A	165	144.223	70.841	12.514	1.00	28.47	O
ATOM	1263	CB	VAL	A	165	145.840	73.131	11.395	1.00	29.47	C
ATOM	1264	CG1	VAL	A	165	145.440	74.176	12.417	1.00	27.78	C
ATOM	1265	CG2	VAL	A	165	146.931	73.687	10.486	1.00	28.52	C
ATOM	1266	N	THR	A	166	145.515	71.228	14.301	1.00	28.43	N
ATOM	1267	CA	THR	A	166	144.551	70.641	15.219	1.00	27.43	C
ATOM	1268	C	THR	A	166	144.388	71.443	16.492	1.00	27.43	C
ATOM	1269	O	THR	A	166	145.090	72.427	16.723	1.00	27.24	O
ATOM	1270	CB	THR	A	166	144.978	69.212	15.652	1.00	28.78	C
ATOM	1271	OG1	THR	A	166	146.169	69.289	16.447	1.00	27.74	O
ATOM	1272	CG2	THR	A	166	145.251	68.333	14.437	1.00	29.11	C
ATOM	1273	N	ALA	A	167	143.451	70.991	17.321	1.00	26.41	N
ATOM	1274	CA	ALA	A	167	143.164	71.612	18.608	1.00	25.08	C
ATOM	1275	C	ALA	A	167	142.994	70.494	19.630	1.00	24.35	C
ATOM	1276	O	ALA	A	167	142.641	69.368	19.282	1.00	23.64	O
ATOM	1277	CB	ALA	A	167	141.900	72.441	18.517	1.00	24.85	C
ATOM	1278	N	ALA	A	168	143.249	70.804	20.893	1.00	24.53	N
ATOM	1279	CA	ALA	A	168	143.131	69.808	21.947	1.00	24.62	C
ATOM	1280	C	ALA	A	168	141.679	69.424	22.180	1.00	25.16	C
ATOM	1281	O	ALA	A	168	140.770	70.186	21.873	1.00	25.69	O
ATOM	1282	CB	ALA	A	168	143.731	70.346	23.232	1.00	24.00	C
ATOM	1283	N	VAL	A	169	141.461	68.234	22.722	1.00	26.41	N
ATOM	1284	CA	VAL	A	169	140.111	67.784	23.018	1.00	27.15	C
ATOM	1285	C	VAL	A	169	139.504	68.792	23.993	1.00	28.21	C
ATOM	1286	O	VAL	A	169	140.173	69.253	24.917	1.00	28.71	O
ATOM	1287	CB	VAL	A	169	140.133	66.394	23.670	1.00	27.41	C
ATOM	1288	CG1	VAL	A	169	138.720	65.941	23.967	1.00	27.70	C
ATOM	1289	CG2	VAL	A	169	140.843	65.403	22.750	1.00	26.92	C
ATOM	1290	N	GLY	A	170	138.247	69.157	23.770	1.00	29.34	N
ATOM	1291	CA	GLY	A	170	137.594	70.107	24.652	1.00	29.95	C
ATOM	1292	C	GLY	A	170	137.638	71.578	24.268	1.00	30.17	C
ATOM	1293	O	GLY	A	170	137.060	72.400	24.972	1.00	30.81	O
ATOM	1294	N	THR	A	171	138.313	71.940	23.181	1.00	31.70	N
ATOM	1295	CA	THR	A	171	138.357	73.347	22.800	1.00	32.99	C
ATOM	1296	C	THR	A	171	136.942	73.680	22.353	1.00	32.68	C
ATOM	1297	O	THR	A	171	136.318	72.891	21.636	1.00	33.39	O
ATOM	1298	CB	THR	A	171	139.329	73.610	21.632	1.00	34.57	C
ATOM	1299	OG1	THR	A	171	138.728	73.204	20.402	1.00	38.21	O
ATOM	1300	CG2	THR	A	171	140.606	72.818	21.823	1.00	34.01	C
ATOM	1301	N	ASP	A	172	136.432	74.831	22.780	1.00	32.59	N
ATOM	1302	CA	ASP	A	172	135.074	75.242	22.441	1.00	31.82	C
ATOM	1303	C	ASP	A	172	135.001	75.879	21.064	1.00	31.23	C
ATOM	1304	O	ASP	A	172	136.026	76.090	20.417	1.00	30.61	O
ATOM	1305	CB	ASP	A	172	134.553	76.209	23.497	1.00	33.64	C
ATOM	1306	CG	ASP	A	172	135.373	77.478	23.574	1.00	36.95	C
ATOM	1307	OD1	ASP	A	172	135.141	78.284	24.499	1.00	40.09	O
ATOM	1308	OD2	ASP	A	172	136.245	77.682	22.706	1.00	38.33	O
ATOM	1309	N	LEU	A	173	133.785	76.183	20.618	1.00	30.04	N
ATOM	1310	CA	LEU	A	173	133.578	76.782	19.307	1.00	30.23	C
ATOM	1311	C	LEU	A	173	134.226	78.152	19.168	1.00	31.09	C
ATOM	1312	O	LEU	A	173	134.694	78.521	18.094	1.00	29.98	O

TABLE 7-continued

ATOM	1313	CB	LEU	A	173	132.084	76.893	19.009	1.00	29.27	C
ATOM	1314	CG	LEU	A	173	131.337	75.561	18.956	1.00	30.61	C
ATOM	1315	CD1	LEU	A	173	129.898	75.791	18.506	1.00	31.11	C
ATOM	1316	CD2	LEU	A	173	132.036	74.623	17.988	1.00	31.30	C
ATOM	1317	N	GLU	A	174	134.264	78.898	20.262	1.00	32.92	N
ATOM	1318	CA	GLU	A	174	134.840	80.230	20.249	1.00	35.64	C
ATOM	1319	C	GLU	A	174	136.335	80.202	19.925	1.00	36.13	C
ATOM	1320	O	GLU	A	174	136.824	81.034	19.157	1.00	35.92	O
ATOM	1321	CB	GLU	A	174	134.617	80.896	21.604	1.00	38.56	C
ATOM	1322	CG	GLU	A	174	134.920	82.379	21.627	1.00	43.61	C
ATOM	1323	CD	GLU	A	174	134.812	82.960	23.025	1.00	46.61	C
ATOM	1324	OE1	GLU	A	174	133.771	82.735	23.687	1.00	48.37	O
ATOM	1325	OE2	GLU	A	174	135.765	83.644	23.457	1.00	48.22	O
ATOM	1326	N	THR	A	175	137.064	79.254	20.508	1.00	36.59	N
ATOM	1327	CA	THR	A	175	138.501	79.156	20.252	1.00	37.34	C
ATOM	1328	C	THR	A	175	138.805	78.488	18.913	1.00	35.61	C
ATOM	1329	O	THR	A	175	139.771	78.853	18.231	1.00	35.02	O
ATOM	1330	CB	THR	A	175	139.234	78.394	21.383	1.00	39.60	C
ATOM	1331	OG1	THR	A	175	140.618	78.248	21.031	1.00	42.14	O
ATOM	1332	CG2	THR	A	175	138.631	77.015	21.596	1.00	42.29	C
ATOM	1333	N	ALA	A	176	137.969	77.519	18.537	1.00	34.40	N
ATOM	1334	CA	ALA	A	176	138.122	76.803	17.271	1.00	33.17	C
ATOM	1335	C	ALA	A	176	137.936	77.780	16.115	1.00	32.96	C
ATOM	1336	O	ALA	A	176	138.682	77.751	15.142	1.00	32.68	O
ATOM	1337	CB	ALA	A	176	137.106	75.680	17.182	1.00	31.85	C
ATOM	1338	N	GLU	A	177	136.937	78.649	16.234	1.00	33.83	N
ATOM	1339	CA	GLU	A	177	136.655	79.657	15.217	1.00	35.00	C
ATOM	1340	C	GLU	A	177	137.902	80.499	15.001	1.00	35.49	C
ATOM	1341	O	GLU	A	177	138.252	80.855	13.876	1.00	36.40	O
ATOM	1342	CB	GLU	A	177	135.526	80.570	15.679	1.00	35.49	C
ATOM	1343	CG	GLU	A	177	135.167	81.644	14.675	1.00	38.23	C
ATOM	1344	CD	GLU	A	177	134.092	82.584	15.185	1.00	40.34	C
ATOM	1345	OE1	GLU	A	177	133.594	83.395	14.378	1.00	41.80	O
ATOM	1346	OE2	GLU	A	177	133.750	82.522	16.390	1.00	42.06	O
ATOM	1347	N	ARG	A	178	138.563	80.815	16.105	1.00	35.48	N
ATOM	1348	CA	ARG	A	178	139.779	81.605	16.099	1.00	35.76	C
ATOM	1349	C	ARG	A	178	140.891	80.849	15.372	1.00	35.00	C
ATOM	1350	O	ARG	A	178	141.604	81.418	14.536	1.00	35.81	O
ATOM	1351	CB	ARG	A	178	140.180	81.888	17.541	1.00	37.77	C
ATOM	1352	CG	ARG	A	178	141.397	82.765	17.737	1.00	41.57	C
ATOM	1353	CD	ARG	A	178	141.581	82.930	19.229	1.00	43.96	C
ATOM	1354	NE	ARG	A	178	140.343	83.441	19.807	1.00	46.74	N
ATOM	1355	CZ	ARG	A	178	139.911	83.163	21.031	1.00	48.54	C
ATOM	1356	NH1	ARG	A	178	140.618	82.369	21.828	1.00	48.33	N
ATOM	1357	NH2	ARG	A	178	138.759	83.675	21.454	1.00	49.63	N
ATOM	1358	N	ILE	A	179	141.034	79.564	15.680	1.00	32.20	N
ATOM	1359	CA	ILE	A	179	142.070	78.763	15.046	1.00	30.42	C
ATOM	1360	C	ILE	A	179	141.753	78.583	13.556	1.00	30.40	C
ATOM	1361	O	ILE	A	179	142.626	78.716	12.707	1.00	30.21	O
ATOM	1362	CB	ILE	A	179	142.201	77.380	15.744	1.00	29.67	C
ATOM	1363	CG1	ILE	A	179	142.477	77.585	17.239	1.00	28.14	C
ATOM	1364	CG2	ILE	A	179	143.327	76.560	15.100	1.00	27.22	C
ATOM	1365	CD1	ILE	A	179	142.463	76.313	18.067	1.00	26.32	C
ATOM	1366	N	LEU	A	180	140.499	78.292	13.240	1.00	30.34	N
ATOM	1367	CA	LEU	A	180	140.102	78.107	11.849	1.00	31.10	C
ATOM	1368	C	LEU	A	180	140.345	79.366	11.025	1.00	31.52	C
ATOM	1369	O	LEU	A	180	140.713	79.290	9.856	1.00	30.22	O
ATOM	1370	CB	LEU	A	180	138.623	77.713	11.769	1.00	31.47	C
ATOM	1371	CG	LEU	A	180	138.242	76.307	12.247	1.00	30.67	C
ATOM	1372	CD1	LEU	A	180	136.735	76.209	12.402	1.00	32.24	C
ATOM	1373	CD2	LEU	A	180	138.752	75.273	11.256	1.00	30.35	C
ATOM	1374	N	HIS	A	181	140.139	80.524	11.642	1.00	33.19	N
ATOM	1375	CA	HIS	A	181	140.340	81.790	10.953	1.00	35.20	C
ATOM	1376	C	HIS	A	181	141.806	82.126	10.694	1.00	36.88	C
ATOM	1377	O	HIS	A	181	142.149	82.651	9.631	1.00	36.71	O
ATOM	1378	CB	HIS	A	161	139.665	82.930	11.728	1.00	35.30	C
ATOM	1379	CG	HIS	A	181	138.169	82.952	11.590	1.00	36.21	C
ATOM	1380	ND1	HIS	A	181	137.379	83.913	12.186	1.00	35.97	N
ATOM	1381	CD2	HIS	A	181	137.323	82.143	10.906	1.00	35.37	C
ATOM	1382	CE1	HIS	A	181	136.113	83.695	11.875	1.00	35.54	C
ATOM	1383	NE2	HIS	A	181	136.052	82.628	11.100	1.00	35.36	N
ATOM	1384	N	GLU	A	182	142.677	81.827	11.650	1.00	38.45	N
ATOM	1385	CA	GLU	A	182	144.092	82.123	11.476	1.00	39.85	C
ATOM	1386	C	GLU	A	182	144.760	81.234	10.436	1.00	38.65	C
ATOM	1387	O	GLU	A	182	145.780	81.608	9.861	1.00	38.54	O
ATOM	1388	CB	GLU	A	182	144.849	81.960	12.790	1.00	43.25	C
ATOM	1389	CG	GLU	A	182	146.348	82.210	12.626	1.00	49.40	C
ATOM	1390	CD	GLU	A	182	147.159	81.826	13.855	1.00	53.96	C
ATOM	1391	OE1	GLU	A	182	148.394	82.037	13.826	1.00	56.51	O

TABLE 7-continued

ATOM	1392	OE2	GLU	A	182	146.570	81.310	14.840	1.00	55.87	O
ATOM	1393	N	HIS	A	183	144.183	80.062	10.196	1.00	37.07	N
ATOM	1394	CA	HIS	A	183	144.758	79.101	9.262	1.00	36.26	C
ATOM	1395	C	HIS	A	183	143.963	78.982	7.973	1.00	36.75	C
ATOM	1396	O	HIS	A	183	144.223	78.101	7.146	1.00	36.54	O
ATOM	1397	CB	HIS	A	183	144.846	77.743	9.955	1.00	34.77	C
ATOM	1398	CG	HIS	A	183	145.625	77.778	11.235	1.00	34.78	C
ATOM	1399	ND1	HIS	A	183	147.004	77.752	11.271	1.00	35.14	N
ATOM	1400	CD2	HIS	A	183	145.220	77.922	12.519	1.00	33.17	C
ATOM	1401	CE1	HIS	A	183	147.412	77.878	12.521	1.00	34.52	C
ATOM	1402	NE2	HIS	A	183	146.349	77.985	13.297	1.00	34.67	N
ATOM	1403	N	ARG	A	184	142.997	79.880	7.807	1.00	37.38	N
ATOM	1404	CA	ARG	A	184	142.147	79.887	6.622	1.00	37.97	C
ATOM	1405	C	ARG	A	184	141.668	78.485	6.287	1.00	36.24	C
ATOM	1406	O	ARG	A	184	141.815	78.034	5.157	1.00	34.85	O
ATOM	1407	CB	ARG	A	184	142.897	80.473	5.420	1.00	40.41	C
ATOM	1408	CG	ARG	A	184	143.263	81.954	5.537	1.00	44.51	C
ATOM	1409	CD	ARG	A	184	144.039	82.396	4.299	1.00	49.58	C
ATOM	1410	NE	ARG	A	184	143.298	82.080	3.076	1.00	54.75	N
ATOM	1411	CZ	ARG	A	184	143.764	82.247	1.839	1.00	57.24	C
ATOM	1412	NH1	ARG	A	184	144.987	82.733	1.640	1.00	58.91	N
ATOM	1413	NH2	ARG	A	184	143.007	81.923	0.796	1.00	58.17	N
ATOM	1414	N	ILE	A	185	141.107	77.797	7.279	1.00	34.80	N
ATOM	1415	CA	ILE	A	185	140.589	76.447	7.079	1.00	34.18	C
ATOM	1416	C	ILE	A	185	139.142	76.323	7.542	1.00	34.03	C
ATOM	1417	O	ILE	A	185	138.648	77.157	8.299	1.00	32.73	O
ATOM	1418	CB	ILE	A	185	141.433	75.387	7.822	1.00	33.30	C
ATOM	1419	CG1	ILE	A	185	141.606	75.789	9.286	1.00	32.78	C
ATOM	1420	CG2	ILE	A	185	142.767	75.198	7.114	1.00	33.84	C
ATOM	1421	CD1	ILE	A	185	142.348	74.769	10.120	1.00	32.98	C
ATOM	1422	N	GLU	A	186	138.467	75.273	7.086	1.00	34.75	N
ATOM	1423	CA	GLU	A	186	137.075	75.057	7.450	1.00	35.67	C
ATOM	1424	C	GLU	A	186	136.815	73.918	8.430	1.00	34.22	C
ATOM	1425	O	GLU	A	186	135.795	73.926	9.110	1.00	34.10	O
ATOM	1426	CB	GLU	A	186	136.242	74.863	6.187	1.00	38.26	C
ATOM	1427	CG	GLU	A	186	136.193	76.098	5.321	1.00	42.63	C
ATOM	1428	CD	GLU	A	186	135.354	75.899	4.080	1.00	47.23	C
ATOM	1429	OE1	GLU	A	186	135.168	76.884	3.328	1.00	50.49	O
ATOM	1430	OE2	GLU	A	186	134.880	74.761	3.848	1.00	48.96	O
ATOM	1431	N	LYS	A	187	137.721	72.942	8.496	1.00	33.47	N
ATOM	1432	CA	LYS	A	187	137.590	71.805	9.422	1.00	32.86	C
ATOM	1433	C	LYS	A	187	138.755	71.785	10.411	1.00	30.96	C
ATOM	1434	O	LYS	A	187	139.917	71.876	10.012	1.00	30.22	O
ATOM	1435	CB	LYS	A	187	137.565	70.456	8.674	1.00	34.99	C
ATOM	1436	CG	LYS	A	187	136.246	70.067	8.021	1.00	38.77	C
ATOM	1437	CD	LYS	A	187	135.898	70.942	6.827	1.00	43.65	C
ATOM	1438	CE	LYS	A	187	136.826	70.688	5.634	1.00	47.20	C
ATOM	1439	NZ	LYS	A	187	136.695	69.309	5.064	1.00	48.81	N
ATOM	1440	N	LEU	A	188	138.451	71.654	11.697	1.00	28.56	N
ATOM	1441	CA	LEU	A	188	139.500	71.619	12.714	1.00	26.39	C
ATOM	1442	C	LEU	A	188	139.439	70.340	13.533	1.00	26.27	C
ATOM	1443	O	LEU	A	188	138.629	70.228	14.448	1.00	26.83	O
ATOM	1444	CB	LEU	A	188	139.364	72.812	13.658	1.00	25.30	C
ATOM	1445	CG	LEU	A	188	140.373	72.899	14.804	1.00	25.12	C
ATOM	1446	CD1	LEU	A	188	141.779	73.097	14.245	1.00	24.40	C
ATOM	1447	CD2	LEU	A	188	140.001	74.055	15.709	1.00	25.16	C
ATOM	1448	N	PRO	A	189	140.299	69.360	13.222	1.00	25.63	N
ATOM	1449	CA	PRO	A	189	140.327	68.088	13.949	1.00	25.71	C
ATOM	1450	C	PRO	A	189	140.736	68.292	15.405	1.00	25.74	C
ATOM	1451	O	PRO	A	189	141.598	69.120	15.704	1.00	25.84	O
ATOM	1452	CB	PRO	A	189	141.372	67.284	13.179	1.00	25.33	C
ATOM	1453	CG	PRO	A	189	141.290	67.884	11.789	1.00	26.79	C
ATOM	1454	CD	PRO	A	189	141.316	69.339	12.163	1.00	25.56	C
ATOM	1455	N	LEU	A	190	140.104	67.546	16.306	1.00	26.25	N
ATOM	1456	CA	LEU	A	190	140.414	67.623	17.729	1.00	25.59	C
ATOM	1457	C	LEU	A	190	141.105	66.314	18.076	1.00	26.60	C
ATOM	1458	O	LEU	A	190	140.565	65.227	17.833	1.00	26.44	O
ATOM	1459	CB	LEU	A	190	139.139	67.777	18.557	1.00	24.57	C
ATOM	1460	CG	LEU	A	190	138.236	68.966	18.223	1.00	24.56	C
ATOM	1461	CD1	LEU	A	190	137.073	68.992	19.206	1.00	24.55	C
ATOM	1462	CD2	LEU	A	190	139.026	70.266	18.309	1.00	24.12	C
ATOM	1463	N	VAL	A	191	142.303	66.411	18.639	1.00	27.41	N
ATOM	1464	CA	VAL	A	191	143.069	65.223	18.984	1.00	26.97	C
ATOM	1465	C	VAL	A	191	143.589	65.339	20.403	1.00	27.90	C
ATOM	1466	O	VAL	A	191	143.693	66.442	20.929	1.00	27.60	O
ATOM	1467	CB	VAL	A	191	144.267	65.065	18.024	1.00	26.42	C
ATOM	1468	CG1	VAL	A	191	143.769	65.012	16.585	1.00	25.29	C
ATOM	1469	CG2	VAL	A	191	145.236	66.225	18.196	1.00	25.51	C
ATOM	1470	N	ASP	A	192	143.895	64.211	21.039	1.00	29.14	N

TABLE 7-continued

ATOM	1471	CA	ASP	A	192	144.449	64.285	22.381	1.00	29.84	C
ATOM	1472	C	ASP	A	192	145.958	64.466	22.287	1.00	29.63	C
ATOM	1473	O	ASP	A	192	146.528	64.519	21.190	1.00	28.08	O
ATOM	1474	CB	ASP	A	192	144.117	63.049	23.237	1.00	29.60	C
ATOM	1475	CG	ASP	A	192	144.600	61.748	22.633	1.00	29.23	C
ATOM	1476	OD1	ASP	A	192	145.698	61.693	22.045	1.00	29.02	O
ATOM	1477	OD2	ASP	A	192	143.880	60.751	22.791	1.00	32.38	O
ATOM	1478	N	ASN	A	193	146.595	64.564	23.447	1.00	30.91	N
ATOM	1479	CA	ASN	A	193	148.033	64.774	23.525	1.00	32.71	C
ATOM	1480	C	ASN	A	193	148.867	63.703	22.840	1.00	33.29	C
ATOM	1481	O	ASN	A	193	150.085	63.832	22.720	1.00	33.19	O
ATOM	1482	CB	ASN	A	193	148.440	64.909	24.987	1.00	34.40	C
ATOM	1483	CG	ASN	A	193	149.093	66.230	25.272	1.00	35.62	C
ATOM	1484	OD1	ASN	A	193	148.574	67.279	24.901	1.00	37.39	O
ATOM	1485	ND2	ASN	A	193	150.236	66.193	25.938	1.00	38.24	N
ATOM	1486	N	SER	A	194	148.203	62.652	22.376	1.00	33.93	N
ATOM	1487	CA	SER	A	194	148.879	61.564	21.691	1.00	33.58	C
ATOM	1488	C	SER	A	194	148.552	61.538	20.209	1.00	32.89	C
ATOM	1489	O	SER	A	194	148.921	60.592	19.522	1.00	33.82	O
ATOM	1490	CB	SER	A	194	148.494	60.227	22.323	1.00	34.55	C
ATOM	1491	OG	SER	A	194	149.014	60.139	23.643	1.00	37.23	O
ATOM	1492	N	GLY	A	195	147.861	62.566	19.717	1.00	31.61	N
ATOM	1493	CA	GLY	A	195	147.505	62.613	18.305	1.00	29.53	C
ATOM	1494	C	GLY	A	195	146.314	61.738	17.930	1.00	29.01	C
ATOM	1495	O	GLY	A	195	146.060	61.483	16.756	1.00	28.69	O
ATOM	1496	N	ARG	A	196	145.578	61.274	18.932	1.00	28.50	N
ATOM	1497	CA	ARG	A	196	144.412	60.441	18.696	1.00	28.40	C
ATOM	1498	C	ARG	A	196	143.202	61.325	18.409	1.00	27.84	C
ATOM	1499	O	ARG	A	196	142.906	62.253	19.161	1.00	27.44	O
ATOM	1500	CB	ARG	A	196	144.152	59.560	19.922	1.00	30.26	C
ATOM	1501	CG	ARG	A	196	142.860	58.752	19.887	1.00	31.17	C
ATOM	1502	CD	ARG	A	196	142.663	58.063	21.216	1.00	33.36	C
ATOM	1503	NE	ARG	A	196	141.253	57.834	21.501	1.00	38.05	N
ATOM	1504	CZ	ARG	A	196	140.471	57.008	20.822	1.00	39.60	C
ATOM	1505	NH1	ARG	A	196	140.966	56.321	19.808	1.00	42.65	N
ATOM	1506	NH2	ARG	A	196	139.192	56.877	21.152	1.00	40.11	N
ATOM	1507	N	LEU	A	197	142.510	61.030	17.313	1.00	27.30	N
ATOM	1508	CA	LEU	A	197	141.332	61.792	16.904	1.00	27.90	C
ATOM	1509	C	LEU	A	197	140.125	61.586	17.825	1.00	27.27	C
ATOM	1510	O	LEU	A	197	139.661	60.460	17.997	1.00	26.44	O
ATOM	1511	CB	LEU	A	197	140.928	61.394	15.488	1.00	26.93	C
ATOM	1512	CG	LEU	A	197	139.711	62.116	14.912	1.00	26.60	C
ATOM	1513	CD1	LEU	A	197	140.067	63.569	14.604	1.00	24.69	C
ATOM	1514	CD2	LEU	A	197	139.268	61.396	13.637	1.00	26.73	C
ATOM	1515	N	SER	A	198	139.610	62.674	18.393	1.00	26.75	N
ATOM	1516	CA	SER	A	198	138.452	62.585	19.277	1.00	27.12	C
ATOM	1517	C	SER	A	198	137.202	63.163	18.635	1.00	27.80	C
ATOM	1518	O	SER	A	198	136.093	62.836	19.038	1.00	29.05	O
ATOM	1519	CB	SER	A	198	138.703	63.331	20.581	1.00	27.75	C
ATOM	1520	OG	SER	A	198	138.836	64.720	20.352	1.00	28.75	O
ATOM	1521	N	GLY	A	199	137.380	64.035	17.647	1.00	27.55	N
ATOM	1522	CA	GLY	A	199	136.240	64.641	16.990	1.00	26.57	C
ATOM	1523	C	GLY	A	199	136.681	65.739	16.050	1.00	26.31	C
ATOM	1524	O	GLY	A	199	137.874	65.905	15.814	1.00	26.69	O
ATOM	1525	N	LEU	A	200	135.727	66.502	15.534	1.00	25.94	N
ATOM	1526	CA	LEU	A	200	136.031	67.564	14.590	1.00	26.36	C
ATOM	1527	C	LEU	A	200	135.040	68.719	14.635	1.00	25.73	C
ATOM	1528	O	LEU	A	200	133.839	68.505	14.730	1.00	24.48	O
ATOM	1529	CB	LEU	A	200	136.102	66.966	13.173	1.00	28.24	C
ATOM	1530	CG	LEU	A	200	136.355	67.848	11.938	1.00	30.21	C
ATOM	1531	CD1	LEU	A	200	136.938	67.013	10.809	1.00	30.99	C
ATOM	1532	CD2	LEU	A	200	135.063	68.517	11.506	1.00	32.05	C
ATOM	1533	N	ILE	A	201	135.567	69.942	14.584	1.00	26.65	N
ATOM	1534	CA	ILE	A	201	134.759	71.160	14.591	1.00	27.46	C
ATOM	1535	C	ILE	A	201	134.862	71.811	13.205	1.00	29.38	C
ATOM	1536	O	ILE	A	201	135.944	71.871	12.604	1.00	29.46	O
ATOM	1537	CB	ILE	A	201	135.244	72.150	15.660	1.00	26.43	C
ATOM	1538	CG1	ILE	A	201	135.132	71.508	17.047	1.00	27.07	C
ATOM	1539	CG2	ILE	A	201	134.417	73.423	15.595	1.00	27.71	C
ATOM	1540	CD1	ILE	A	201	135.613	72.380	18.218	1.00	24.40	C
ATOM	1541	N	THR	A	202	133.728	72.296	12.703	1.00	30.75	N
ATOM	1542	CA	THR	A	202	133.660	72.906	11.379	1.00	32.31	C
ATOM	1543	C	THR	A	202	133.207	74.358	11.414	1.00	32.21	C
ATOM	1544	O	THR	A	202	132.650	74.825	12.405	1.00	31.14	O
ATOM	1545	CB	THR	A	202	132.691	72.113	10.472	1.00	33.40	C
ATOM	1546	OG1	THR	A	202	133.146	70.760	10.361	1.00	36.21	O
ATOM	1547	CG2	THR	A	202	132.632	72.718	9.080	1.00	36.76	C
ATOM	1548	N	ILE	A	203	133.452	75.066	10.315	1.00	33.57	N
ATOM	1549	CA	ILE	A	203	133.062	76.461	10.196	1.00	33.87	C

TABLE 7-continued

ATOM	1550	C	ILE	A	203	131.531	76.544	10.244	1.00	34.10	C
ATOM	1551	O	ILE	A	203	130.978	77.430	10.887	1.00	33.80	O
ATOM	1552	CB	ILE	A	203	133.621	77.084	8.877	1.00	33.87	C
ATOM	1553	CG1	ILE	A	203	133.384	78.589	8.869	1.00	33.89	C
ATOM	1554	CG2	ILE	A	203	132.995	76.434	7.664	1.00	34.39	C
ATOM	1555	CD1	ILE	A	203	134.165	79.321	9.950	1.00	34.38	C
ATOM	1556	N	LYS	A	204	130.852	75.605	9.587	1.00	34.73	N
ATOM	1557	CA	LYS	A	204	129.388	75.578	9.588	1.00	36.17	C
ATOM	1558	C	LYS	A	204	128.838	75.505	11.014	1.00	36.21	C
ATOM	1559	O	LYS	A	204	127.916	76.243	11.360	1.00	36.39	O
ATOM	1560	CB	LYS	A	204	128.857	74.386	8.782	1.00	38.20	C
ATOM	1561	CG	LYS	A	204	129.058	74.473	7.284	1.00	41.84	C
ATOM	1562	CD	LYS	A	204	130.529	74.521	6.918	1.00	47.07	C
ATOM	1563	CE	LYS	A	204	130.723	74.686	5.410	1.00	50.14	C
ATOM	1564	NZ	LYS	A	204	132.165	74.843	5.037	1.00	52.54	N
ATOM	1565	N	ASP	A	205	129.391	74.611	11.834	1.00	36.04	N
ATOM	1566	CA	ASP	A	205	128.950	74.472	13.224	1.00	36.48	C
ATOM	1567	C	ASP	A	205	128.922	75.830	13.886	1.00	35.58	C
ATOM	1568	O	ASP	A	205	127.995	76.162	14.624	1.00	36.04	O
ATOM	1569	CB	ASP	A	205	129.909	73.606	14.036	1.00	38.56	C
ATOM	1570	CG	ASP	A	205	129.957	72.189	13.569	1.00	40.22	C
ATOM	1571	OD1	ASP	A	205	130.764	71.431	14.141	1.00	41.68	O
ATOM	1572	OD2	ASP	A	205	129.196	71.833	12.644	1.00	42.07	O
ATOM	1573	N	ILE	A	206	129.970	76.604	13.637	1.00	34.72	N
ATOM	1574	CA	ILE	A	206	130.092	77.933	14.209	1.00	34.65	C
ATOM	1575	C	ILE	A	206	129.025	78.854	13.628	1.00	34.32	C
ATOM	1576	O	ILE	A	206	128.466	79.693	14.326	1.00	34.37	O
ATOM	1577	CB	ILE	A	206	131.494	78.485	13.933	1.00	34.36	C
ATOM	1578	CG1	ILE	A	206	132.522	77.495	14.486	1.00	35.28	C
ATOM	1579	CG2	ILE	A	206	131.665	79.849	14.575	1.00	34.33	C
ATOM	1580	CD1	ILE	A	206	133.948	77.829	14.164	1.00	36.11	C
ATOM	1581	N	GLU	A	207	128.732	78.669	12.348	1.00	34.71	N
ATOM	1582	CA	GLU	A	207	127.737	79.479	11.671	1.00	35.12	C
ATOM	1583	C	GLU	A	207	126.326	79.117	12.120	1.00	34.48	C
ATOM	1584	O	GLU	A	207	125.462	79.991	12.222	1.00	34.41	O
ATOM	1585	CB	GLU	A	207	127.864	79.302	10.160	1.00	36.78	C
ATOM	1586	CG	GLU	A	207	129.266	79.555	9.649	1.00	39.03	C
ATOM	1587	CD	GLU	A	207	129.353	79.532	8.139	1.00	41.21	C
ATOM	1588	OE1	GLU	A	207	128.871	78.550	7.519	1.00	41.65	O
ATOM	1589	OE2	GLU	A	207	129.918	80.497	7.575	1.00	43.02	O
ATOM	1590	N	LYS	A	208	126.090	77.835	12.392	1.00	32.85	N
ATOM	1591	CA	LYS	A	208	124.770	77.396	12.838	1.00	31.74	C
ATOM	1592	C	LYS	A	208	124.462	77.924	14.223	1.00	30.98	C
ATOM	1593	O	LYS	A	208	123.306	78.107	14.577	1.00	31.35	O
ATOM	1594	CB	LYS	A	208	124.668	75.874	12.824	1.00	31.08	C
ATOM	1595	CG	LYS	A	208	124.654	75.281	11.429	1.00	32.19	C
ATOM	1596	CD	LYS	A	208	124.629	73.769	11.485	1.00	32.69	C
ATOM	1597	CE	LYS	A	208	124.667	73.162	10.102	1.00	33.70	C
ATOM	1598	NZ	LYS	A	208	124.676	71.678	10.190	1.00	35.26	N
ATOM	1599	N	VAL	A	209	125.499	78.172	15.010	1.00	31.31	N
ATOM	1600	CA	VAL	A	209	125.305	78.713	16.346	1.00	31.66	C
ATOM	1601	C	VAL	A	209	124.770	80.136	16.169	1.00	32.91	C
ATOM	1602	O	VAL	A	209	123.948	80.614	16.953	1.00	33.61	O
ATOM	1603	CB	VAL	A	209	126.634	78.733	17.137	1.00	30.78	C
ATOM	1604	CG1	VAL	A	209	126.430	79.378	18.494	1.00	30.86	C
ATOM	1605	CG2	VAL	A	209	127.151	77.323	17.307	1.00	29.89	C
ATOM	1606	N	ILE	A	210	125.236	80.807	15.120	1.00	33.36	N
ATOM	1607	CA	ILE	A	210	124.791	82.164	14.822	1.00	34.24	C
ATOM	1608	C	ILE	A	210	123.357	82.142	14.291	1.00	33.53	C
ATOM	1609	O	ILE	A	210	122.480	82.843	14.798	1.00	32.71	O
ATOM	1610	CB	ILE	A	210	125.712	82.834	13.766	1.00	35.30	C
ATOM	1611	CG1	ILE	A	210	127.090	83.101	14.378	1.00	36.13	C
ATOM	1612	CG2	ILE	A	210	125.080	84.121	13.243	1.00	34.62	C
ATOM	1613	CD1	ILE	A	210	127.040	83.976	15.620	1.00	37.62	C
ATOM	1614	N	GLU	A	211	123.135	81.320	13.271	1.00	33.34	N
ATOM	1615	CA	GLU	A	211	121.832	81.179	12.635	1.00	33.18	C
ATOM	1616	C	GLU	A	211	120.689	80.778	13.565	1.00	32.49	C
ATOM	1617	O	GLU	A	211	119.572	81.266	13.405	1.00	32.64	O
ATOM	1618	CB	GLU	A	211	121.943	80.186	11.482	1.00	34.14	C
ATOM	1619	CG	GLU	A	211	120.657	79.924	10.751	1.00	36.42	C
ATOM	1620	CD	GLU	A	211	120.868	78.997	9.582	1.00	39.42	C
ATOM	1621	OE1	GLU	A	211	121.606	78.009	9.757	1.00	42.56	O
ATOM	1622	OE2	GLU	A	211	120.292	79.233	8.499	1.00	40.95	O
ATOM	1623	N	PHE	A	212	120.952	79.893	14.526	1.00	31.88	N
ATOM	1624	CA	PHE	A	212	119.912	79.465	15.466	1.00	30.57	C
ATOM	1625	C	PHE	A	212	120.409	79.610	16.902	1.00	30.83	C
ATOM	1626	O	PHE	A	212	120.705	78.622	17.578	1.00	30.70	O
ATOM	1627	CB	PHE	A	212	119.510	78.007	15.234	1.00	29.04	C
ATOM	1628	CG	PHE	A	212	119.187	77.673	13.807	1.00	27.87	C

TABLE 7-continued

ATOM	1629	CD1	PHE	A	212	120.161	77.139	12.969	1.00	27.41	C
ATOM	1630	CD2	PHE	A	212	117.905	77.864	13.307	1.00	27.70	C
ATOM	1631	CE1	PHE	A	212	119.863	76.792	11.651	1.00	27.08	C
ATOM	1632	CE2	PHE	A	212	117.595	77.520	11.985	1.00	28.23	C
ATOM	1633	CZ	PHE	A	212	118.578	76.982	11.159	1.00	27.46	C
ATOM	1634	N	PRO	A	213	120.482	80.850	17.396	1.00	30.79	N
ATOM	1635	CA	PRO	A	213	120.943	81.168	18.745	1.00	30.59	C
ATOM	1636	C	PRO	A	213	120.208	80.531	19.926	1.00	30.81	C
ATOM	1637	O	PRO	A	213	120.792	80.375	20.991	1.00	32.42	O
ATOM	1638	CB	PRO	A	213	120.853	82.693	18.766	1.00	30.59	C
ATOM	1639	CG	PRO	A	213	119.680	82.949	17.850	1.00	29.65	C
ATOM	1640	CD	PRO	A	213	120.117	82.091	16.697	1.00	30.72	C
ATOM	1641	N	HIS	A	214	118.944	80.156	19.757	1.00	31.01	N
ATOM	1642	CA	HIS	A	214	118.193	79.589	20.872	1.00	29.81	C
ATOM	1643	C	HIS	A	214	117.983	78.090	20.793	1.00	28.54	C
ATOM	1644	O	HIS	A	214	117.133	77.549	21.499	1.00	26.06	O
ATOM	1645	CB	HIS	A	214	116.825	80.258	20.990	1.00	32.85	C
ATOM	1646	CG	HIS	A	214	116.876	81.752	20.955	1.00	36.67	C
ATOM	1647	ND1	HIS	A	214	116.854	82.469	19.776	1.00	38.33	N
ATOM	1648	CD2	HIS	A	214	116.998	82.663	21.949	1.00	37.66	C
ATOM	1649	CE1	HIS	A	214	116.960	83.758	20.047	1.00	38.52	C
ATOM	1650	NE2	HIS	A	214	117.049	83.903	21.357	1.00	38.92	N
ATOM	1651	N	ALA	A	215	118.756	77.424	19.943	1.00	27.04	N
ATOM	1652	CA	ALA	A	215	118.633	75.984	19.774	1.00	26.19	C
ATOM	1653	C	ALA	A	215	118.800	75.263	21.100	1.00	25.46	C
ATOM	1654	O	ALA	A	215	119.618	75.658	21.924	1.00	25.60	O
ATOM	1655	CB	ALA	A	215	119.667	75.486	18.768	1.00	25.12	C
ATOM	1656	N	ALA	A	216	118.004	74.216	21.305	1.00	25.96	N
ATOM	1657	CA	ALA	A	216	118.072	73.417	22.523	1.00	25.69	C
ATOM	1658	C	ALA	A	216	119.095	72.341	22.211	1.00	26.07	C
ATOM	1659	O	ALA	A	216	118.880	71.516	21.327	1.00	27.31	O
ATOM	1660	CB	ALA	A	216	116.714	72.797	22.824	1.00	25.56	C
ATOM	1661	N	LYS	A	217	120.212	72.355	22.931	1.00	26.34	N
ATOM	1662	CA	LYS	A	217	121.289	71.409	22.677	1.00	25.73	C
ATOM	1663	C	LYS	A	217	121.786	70.689	23.918	1.00	26.81	C
ATOM	1664	O	LYS	A	217	121.480	71.084	25.044	1.00	25.57	O
ATOM	1665	CB	LYS	A	217	122.450	72.150	22.015	1.00	25.06	C
ATOM	1666	CG	LYS	A	217	122.081	72.771	20.672	1.00	24.94	C
ATOM	1667	CD	LYS	A	217	123.162	73.693	20.150	1.00	24.62	C
ATOM	1668	CE	LYS	A	217	122.830	74.159	18.749	1.00	26.52	C
ATOM	1669	NZ	LYS	A	217	123.873	75.063	18.196	1.00	28.65	N
ATOM	1670	N	ASP	A	218	122.546	69.616	23.700	1.00	28.28	N
ATOM	1671	CA	ASP	A	218	123.106	68.855	24.808	1.00	29.53	C
ATOM	1672	C	ASP	A	218	124.458	69.434	25.200	1.00	29.72	C
ATOM	1673	O	ASP	A	218	124.864	70.494	24.715	1.00	27.51	O
ATOM	1674	CB	ASP	A	218	123.270	67.363	24.458	1.00	30.13	C
ATOM	1675	CG	ASP	A	218	124.142	67.130	23.231	1.00	32.50	C
ATOM	1676	OD1	ASP	A	218	125.144	67.853	23.060	1.00	33.09	O
ATOM	1677	OD2	ASP	A	218	123.848	66.200	22.447	1.00	32.34	O
ATOM	1678	N	GLU	A	219	125.143	68.718	26.082	1.00	31.09	N
ATOM	1679	CA	GLU	A	219	126.445	69.117	26.586	1.00	33.04	C
ATOM	1680	C	GLU	A	219	127.492	69.306	25.505	1.00	31.97	C
ATOM	1681	O	GLU	A	219	128.455	70.037	25.697	1.00	33.31	O
ATOM	1682	CB	GLU	A	219	126.931	68.087	27.613	1.00	36.51	C
ATOM	1683	CG	GLU	A	219	126.807	66.636	27.148	1.00	43.30	C
ATOM	1684	CD	GLU	A	219	127.129	65.626	28.245	1.00	46.43	C
ATOM	1685	OE1	GLU	A	219	126.570	65.740	29.358	1.00	49.99	O
ATOM	1686	OE2	GLU	A	219	127.926	64.702	27.994	1.00	49.56	O
ATOM	1687	N	PHE	A	220	127.297	68.663	24.363	1.00	31.08	N
ATOM	1688	CA	PHE	A	220	128.253	68.753	23.264	1.00	30.41	C
ATOM	1689	C	PHE	A	220	127.863	69.773	22.205	1.00	30.02	C
ATOM	1690	O	PHE	A	220	128.534	69.897	21.180	1.00	30.29	O
ATOM	1691	CB	PHE	A	220	128.401	67.378	22.619	1.00	30.42	C
ATOM	1692	CG	PHE	A	220	128.737	66.292	23.600	1.00	31.61	C
ATOM	1693	CD1	PHE	A	220	129.949	66.306	24.287	1.00	31.76	C
ATOM	1694	CD2	PHE	A	220	127.831	65.267	23.855	1.00	31.51	C
ATOM	1695	CE1	PHE	A	220	130.252	65.317	25.209	1.00	32.04	C
ATOM	1696	CE2	PHE	A	220	128.124	64.276	24.775	1.00	31.75	C
ATOM	1697	CZ	PHE	A	220	129.337	64.299	25.453	1.00	31.56	C
ATOM	1698	N	GLY	A	221	126.773	70.496	22.453	1.00	30.25	N
ATOM	1699	CA	GLY	A	221	126.308	71.485	21.498	1.00	29.06	C
ATOM	1700	C	GLY	A	221	125.573	70.852	20.325	1.00	28.96	C
ATOM	1701	O	GLY	A	221	125.519	71.417	19.232	1.00	27.40	O
ATOM	1702	N	ARG	A	222	125.029	69.658	20.551	1.00	28.41	N
ATOM	1703	CA	ARG	A	222	124.269	68.949	19.534	1.00	27.01	C
ATOM	1704	C	ARG	A	222	122.797	69.105	19.909	1.00	25.67	C
ATOM	1705	O	ARG	A	222	122.448	69.100	21.081	1.00	24.90	O
ATOM	1706	CB	ARG	A	222	124.640	67.470	19.518	1.00	26.66	C
ATOM	1707	CG	ARG	A	222	126.102	67.212	19.270	1.00	27.12	C

TABLE 7-continued

ATOM	1708	CD	ARG	A	222	126.398	65.719	19.306	1.00	28.42	C
ATOM	1709	NE	ARG	A	222	125.961	65.097	20.559	1.00	30.08	N
ATOM	1710	CZ	ARG	A	222	126.067	63.799	20.827	1.00	27.75	C
ATOM	1711	NH1	ARG	A	222	126.599	62.973	19.934	1.00	25.60	N
ATOM	1712	NH2	ARG	A	222	125.620	63.328	21.981	1.00	27.54	N
ATOM	1713	N	LEU	A	223	121.944	69.248	18.906	1.00	25.37	N
ATOM	1714	CA	LEU	A	223	120.506	69.417	19.129	1.00	25.09	C
ATOM	1715	C	LEU	A	223	119.943	68.277	19.967	1.00	25.23	C
ATOM	1716	O	LEU	A	223	120.390	67.128	19.853	1.00	25.90	O
ATOM	1717	CB	LEU	A	223	119.766	69.464	17.782	1.00	22.94	C
ATOM	1718	CG	LEU	A	223	120.155	70.538	16.755	1.00	23.39	C
ATOM	1719	CD1	LEU	A	223	119.455	70.265	15.420	1.00	22.13	C
ATOM	1720	CD2	LEU	A	223	119.802	71.917	17.288	1.00	22.20	C
ATOM	1721	N	LEU	A	224	118.963	68.595	20.811	1.00	24.72	N
ATOM	1722	CA	LEU	A	224	118.318	67.585	21.647	1.00	24.86	C
ATOM	1723	C	LEU	A	224	117.331	66.806	20.806	1.00	24.46	C
ATOM	1724	O	LEU	A	224	116.871	67.281	19.775	1.00	24.23	O
ATOM	1725	CB	LEU	A	224	117.545	68.226	22.798	1.00	23.92	C
ATOM	1726	CG	LEU	A	224	118.313	68.961	23.888	1.00	25.09	C
ATOM	1727	CD1	LEU	A	224	117.344	69.527	24.924	1.00	21.77	C
ATOM	1728	CD2	LEU	A	224	119.295	67.987	24.529	1.00	25.24	C
ATOM	1729	N	VAL	A	225	117.008	65.600	21.243	1.00	25.32	N
ATOM	1730	CA	VAL	A	225	116.027	64.803	20.532	1.00	25.61	C
ATOM	1731	C	VAL	A	225	115.498	63.714	21.440	1.00	25.77	C
ATOM	1732	O	VAL	A	225	116.227	63.181	22.282	1.00	25.12	O
ATOM	1733	CB	VAL	A	225	116.601	64.151	19.237	1.00	27.42	C
ATOM	1734	CG1	VAL	A	225	117.632	63.069	19.577	1.00	26.05	C
ATOM	1735	CG2	VAL	A	225	115.456	63.574	18.400	1.00	26.21	C
ATOM	1736	N	ALA	A	226	114.214	63.412	21.272	1.00	24.98	N
ATOM	1737	CA	ALA	A	226	113.547	62.373	22.037	1.00	23.32	C
ATOM	1738	C	ALA	A	226	112.985	61.398	21.013	1.00	23.19	C
ATOM	1739	O	ALA	A	226	112.839	61.734	19.838	1.00	22.48	O
ATOM	1740	CB	ALA	A	226	112.426	62.966	22.876	1.00	22.70	C
ATOM	1741	N	ALA	A	227	112.692	60.184	21.452	1.00	22.90	N
ATOM	1742	CA	ALA	A	227	112.143	59.179	20.560	1.00	24.67	C
ATOM	1743	C	ALA	A	227	111.116	58.381	21.346	1.00	26.09	C
ATOM	1744	O	ALA	A	227	111.237	58.219	22.566	1.00	26.01	O
ATOM	1745	CB	ALA	A	227	113.255	58.266	20.029	1.00	22.84	C
ATOM	1746	N	ALA	A	228	110.098	57.892	20.650	1.00	26.88	N
ATOM	1747	CA	ALA	A	228	109.053	57.130	21.306	1.00	27.92	C
ATOM	1748	C	ALA	A	228	109.201	55.630	21.125	1.00	29.27	C
ATOM	1749	O	ALA	A	228	109.788	55.149	20.153	1.00	28.65	O
ATOM	1750	CB	ALA	A	228	107.697	57.575	20.792	1.00	28.14	C
ATOM	1751	N	VAL	A	229	108.662	54.901	22.091	1.00	30.70	N
ATOM	1752	CA	VAL	A	229	108.654	53.447	22.082	1.00	31.77	C
ATOM	1753	C	VAL	A	229	107.354	53.075	22.785	1.00	33.71	C
ATOM	1754	O	VAL	A	229	106.778	53.897	23.508	1.00	34.20	O
ATOM	1755	CB	VAL	A	229	109.847	52.850	22.876	1.00	31.31	C
ATOM	1756	CG1	VAL	A	229	111.156	53.346	22.298	1.00	31.39	C
ATOM	1757	CG2	VAL	A	229	109.739	53.208	24.357	1.00	31.01	C
ATOM	1758	N	GLY	A	230	106.871	51.858	22.570	1.00	34.88	N
ATOM	1759	CA	GLY	A	230	105.652	51.453	23.240	1.00	35.58	C
ATOM	1760	C	GLY	A	230	105.976	50.476	24.352	1.00	36.88	C
ATOM	1761	O	GLY	A	230	107.100	50.411	24.840	1.00	36.39	O
ATOM	1762	N	VAL	A	231	104.975	49.722	24.772	1.00	39.52	N
ATOM	1763	CA	VAL	A	231	105.176	48.719	25.801	1.00	41.92	C
ATOM	1764	C	VAL	A	231	104.905	47.363	25.140	1.00	43.78	C
ATOM	1765	O	VAL	A	231	103.779	46.858	25.143	1.00	44.73	O
ATOM	1766	CB	VAL	A	231	104.240	48.966	26.997	1.00	41.08	C
ATOM	1767	CG1	VAL	A	231	104.639	50.257	27.691	1.00	40.96	C
ATOM	1768	CG2	VAL	A	231	102.810	49.071	26.526	1.00	40.96	C
ATOM	1769	N	THR	A	232	105.954	46.807	24.538	1.00	44.60	N
ATOM	1770	CA	THR	A	232	105.881	45.532	23.845	1.00	45.87	C
ATOM	1771	C	THR	A	232	107.106	44.710	24.200	1.00	46.68	C
ATOM	1772	O	THR	A	232	107.838	45.059	25.120	1.00	47.51	O
ATOM	1773	CB	THR	A	232	105.842	45.739	22.328	1.00	46.37	C
ATOM	1774	OG1	THR	A	232	107.038	46.404	21.906	1.00	46.75	O
ATOM	1775	CG2	THR	A	232	104.645	46.590	21.946	1.00	46.43	C
ATOM	1776	N	SER	A	233	107.342	43.626	23.468	1.00	48.35	N
ATOM	1777	CA	SER	A	233	108.491	42.768	23.755	1.00	49.99	C
ATOM	1778	C	SER	A	233	109.804	43.315	23.199	1.00	50.98	C
ATOM	1779	O	SER	A	233	110.887	42.949	23.667	1.00	52.13	O
ATOM	1780	CB	SER	A	233	108.256	41.355	23.211	1.00	49.80	C
ATOM	1781	OG	SER	A	233	108.089	41.370	21.809	1.00	51.16	O
ATOM	1782	N	ASP	A	234	109.710	44.197	22.210	1.00	51.06	N
ATOM	1783	CA	ASP	A	234	110.901	44.779	21.606	1.00	51.16	C
ATOM	1784	C	ASP	A	234	111.207	46.174	22.142	1.00	50.20	C
ATOM	1785	O	ASP	A	234	112.024	46.892	21.570	1.00	50.68	O
ATOM	1786	CB	ASP	A	234	110.733	44.835	20.092	1.00	52.65	C

TABLE 7-continued

ATOM	1787	CG	ASP	A	234	109.474	45.563	19.686	1.00	55.59	C
ATOM	1788	OD1	ASP	A	234	108.388	45.134	20.138	1.00	57.24	O
ATOM	1789	OD2	ASP	A	234	109.566	46.556	18.924	1.00	56.62	O
ATOM	1790	N	THR	A	235	110.559	46.553	23.239	1.00	48.92	N
ATOM	1791	CA	THR	A	235	110.775	47.866	23.837	1.00	48.36	C
ATOM	1792	C	THR	A	235	112.219	48.115	24.279	1.00	48.23	C
ATOM	1793	O	THR	A	235	112.835	49.092	23.855	1.00	48.06	O
ATOM	1794	CB	THR	A	235	109.844	48.080	25.035	1.00	48.22	C
ATOM	1795	OG1	THR	A	235	108.492	48.121	24.572	1.00	48.44	O
ATOM	1796	CG2	THR	A	235	110.164	49.382	25.740	1.00	48.44	C
ATOM	1797	N	PHE	A	236	112.755	47.248	25.138	1.00	47.72	N
ATOM	1798	CA	PHE	A	236	114.133	47.403	25.594	1.00	46.43	C
ATOM	1799	C	PHE	A	236	115.075	47.536	24.420	1.00	45.57	C
ATOM	1800	O	PHE	A	236	115.856	48.480	24.342	1.00	45.91	O
ATOM	1801	CB	PHE	A	236	114.568	46.209	26.434	1.00	47.23	C
ATOM	1802	CG	PHE	A	236	114.351	46.394	27.892	1.00	48.55	C
ATOM	1803	CD1	PHE	A	236	115.014	47.402	28.572	1.00	49.39	C
ATOM	1804	CD2	PHE	A	236	113.483	45.567	28.591	1.00	50.16	C
ATOM	1805	CE1	PHE	A	236	114.817	47.588	29.931	1.00	51.05	C
ATOM	1806	CE2	PHE	A	236	113.276	45.742	29.959	1.00	51.03	C
ATOM	1807	CZ	PHE	A	236	113.945	46.755	30.630	1.00	51.13	C
ATOM	1808	N	GLU	A	237	114.998	46.570	23.513	1.00	44.78	N
ATOM	1809	CA	GLU	A	237	115.835	46.548	22.320	1.00	44.06	C
ATOM	1810	C	GLU	A	237	115.749	47.901	21.626	1.00	41.89	C
ATOM	1811	O	GLU	A	237	116.756	48.466	21.210	1.00	41.21	O
ATOM	1812	CB	GLU	A	237	115.334	45.461	21.375	1.00	46.63	C
ATOM	1813	CG	GLU	A	237	116.258	45.132	20.226	1.00	50.92	C
ATOM	1814	CD	GLU	A	237	115.598	44.192	19.233	1.00	54.10	C
ATOM	1815	OE1	GLU	A	237	114.939	43.224	19.686	1.00	55.04	O
ATOM	1816	OE2	GLU	A	237	115.749	44.410	18.004	1.00	55.45	O
ATOM	1817	N	ARG	A	238	114.524	48.410	21.521	1.00	40.47	N
ATOM	1818	CA	ARG	A	238	114.244	49.691	20.880	1.00	39.30	C
ATOM	1819	C	ARG	A	238	114.820	50.864	21.667	1.00	38.27	C
ATOM	1820	O	ARG	A	238	115.508	51.715	21.109	1.00	37.62	O
ATOM	1821	CB	ARG	A	238	112.738	49.888	20.743	1.00	38.03	C
ATOM	1822	CG	ARG	A	238	112.380	50.858	19.656	1.00	38.82	C
ATOM	1823	CD	ARG	A	238	110.901	51.126	19.586	1.00	39.86	C
ATOM	1824	NE	ARG	A	238	110.555	51.547	18.236	1.00	42.82	N
ATOM	1825	CZ	ARG	A	238	110.332	50.707	17.233	1.00	43.08	C
ATOM	1826	NH1	ARG	A	238	110.410	49.402	17.430	1.00	44.36	N
ATOM	1827	NH2	ARG	A	238	110.066	51.170	16.025	1.00	43.46	N
ATOM	1828	N	ALA	A	239	114.518	50.904	22.962	1.00	38.15	N
ATOM	1829	CA	ALA	A	239	114.991	51.960	23.848	1.00	37.99	C
ATOM	1830	C	ALA	A	239	116.516	52.030	23.869	1.00	39.80	C
ATOM	1831	O	ALA	A	239	117.093	53.121	23.815	1.00	39.71	O
ATOM	1832	CB	ALA	A	239	114.461	51.729	25.249	1.00	36.95	C
ATOM	1833	N	GLU	A	240	117.174	50.873	23.944	1.00	41.10	N
ATOM	1834	CA	GLU	A	240	118.631	50.852	23.965	1.00	41.70	C
ATOM	1835	C	GLU	A	240	119.239	51.237	22.621	1.00	40.70	C
ATOM	1836	O	GLU	A	240	120.358	51.744	22.570	1.00	40.79	O
ATOM	1837	CB	GLU	A	240	119.157	49.486	24.428	1.00	44.05	C
ATOM	1838	CG	GLU	A	240	118.629	48.286	23.678	1.00	48.07	C
ATOM	1839	CD	GLU	A	240	119.141	46.973	24.266	1.00	51.41	C
ATOM	1840	OE1	GLU	A	240	119.010	46.776	25.499	1.00	51.93	O
ATOM	1841	OE2	GLU	A	240	119.664	46.135	23.496	1.00	52.53	O
ATOM	1842	N	ALA	A	241	118.508	51.005	21.536	1.00	39.57	N
ATOM	1843	CA	ALA	A	241	118.999	51.373	20.208	1.00	39.09	C
ATOM	1844	C	ALA	A	241	118.911	52.893	20.071	1.00	38.48	C
ATOM	1845	O	ALA	A	241	119.805	53.533	19.521	1.00	38.30	O
ATOM	1846	CB	ALA	A	241	118.161	50.701	19.125	1.00	39.36	C
ATOM	1847	N	LEU	A	242	117.822	53.460	20.579	1.00	37.48	N
ATOM	1848	CA	LEU	A	242	117.603	54.902	20.549	1.00	36.64	C
ATOM	1849	C	LEU	A	242	118.607	55.648	21.421	1.00	36.34	C
ATOM	1850	O	LEU	A	242	119.217	56.620	20.973	1.00	35.49	O
ATOM	1851	CB	LEU	A	242	116.177	55.212	20.999	1.00	36.24	C
ATOM	1852	CG	LEU	A	242	115.079	55.051	19.940	1.00	37.63	C
ATOM	1853	CD1	LEU	A	242	115.390	53.933	18.970	1.00	37.59	C
ATOM	1854	CD2	LEU	A	242	113.748	54.825	20.654	1.00	37.84	C
ATOM	1855	N	PHE	A	243	118.785	55.209	22.666	1.00	36.35	N
ATOM	1856	CA	PHE	A	243	119.749	55.879	23.534	1.00	36.90	C
ATOM	1857	C	PHE	A	243	121.143	55.806	22.930	1.00	37.73	C
ATOM	1858	O	PHE	A	243	121.890	56.781	22.958	1.00	38.96	O
ATOM	1859	CB	PHE	A	243	119.769	55.262	24.938	1.00	35.66	C
ATOM	1860	CG	PHE	A	243	118.619	55.683	25.803	1.00	34.47	C
ATOM	1861	CD1	PHE	A	243	118.325	57.032	25.980	1.00	34.10	C
ATOM	1862	CD2	PHE	A	243	117.850	54.739	26.474	1.00	33.97	C
ATOM	1863	CE1	PHE	A	243	117.280	57.432	26.818	1.00	33.89	C
ATOM	1864	CE2	PHE	A	243	116.802	55.130	27.317	1.00	33.03	C
ATOM	1865	CZ	PHE	A	243	116.517	56.474	27.489	1.00	32.69	C

TABLE 7-continued

ATOM	1866	N	GLU	A	244	121.477	54.650	22.370	1.00	38.32	N
ATOM	1867	CA	GLU	A	244	122.779	54.431	21.763	1.00	39.15	C
ATOM	1868	C	GLU	A	244	122.974	55.304	20.531	1.00	37.76	C
ATOM	1869	O	GLU	A	244	124.103	55.550	20.103	1.00	37.31	O
ATOM	1870	CB	GLU	A	244	122.932	52.959	21.380	1.00	43.06	C
ATOM	1871	CG	GLU	A	244	124.297	52.595	20.823	1.00	48.69	C
ATOM	1872	CD	GLU	A	244	124.375	51.141	20.407	1.00	53.07	C
ATOM	1873	OE1	GLU	A	244	124.097	50.272	21.266	1.00	55.43	O
ATOM	1874	OE2	GLU	A	244	124.713	50.866	19.228	1.00	54.65	O
ATOM	1875	N	ALA	A	245	121.873	55.767	19.951	1.00	36.29	N
ATOM	1876	CA	ALA	A	245	121.964	56.619	18.770	1.00	35.13	C
ATOM	1877	C	ALA	A	245	122.120	58.061	19.224	1.00	33.93	C
ATOM	1878	O	ALA	A	245	122.455	58.935	18.437	1.00	34.56	O
ATOM	1879	CB	ALA	A	245	120.723	56.463	17.897	1.00	35.38	C
ATOM	1880	N	GLY	A	246	121.873	58.301	20.506	1.00	32.96	N
ATOM	1881	CA	GLY	A	246	122.022	59.640	21.039	1.00	32.17	C
ATOM	1882	C	GLY	A	246	120.812	60.256	21.720	1.00	31.72	C
ATOM	1883	O	GLY	A	246	120.919	61.358	22.265	1.00	32.01	O
ATOM	1884	N	ALA	A	247	119.673	59.570	21.710	1.00	30.21	N
ATOM	1885	CA	ALA	A	247	118.465	60.123	22.328	1.00	29.83	C
ATOM	1886	C	ALA	A	247	118.739	60.676	23.718	1.00	29.13	C
ATOM	1887	O	ALA	A	247	119.392	60.038	24.529	1.00	29.36	O
ATOM	1888	CB	ALA	A	247	117.365	59.064	22.398	1.00	29.66	C
ATOM	1889	N	ASP	A	248	118.231	61.874	23.976	1.00	29.42	N
ATOM	1890	CA	ASP	A	248	118.401	62.541	25.262	1.00	29.22	C
ATOM	1891	C	ASP	A	248	117.283	62.141	26.218	1.00	28.93	C
ATOM	1892	O	ASP	A	248	117.334	62.412	27.416	1.00	28.35	O
ATOM	1893	CB	ASP	A	248	118.400	64.049	25.032	1.00	31.00	C
ATOM	1894	CG	ASP	A	248	119.557	64.495	24.153	1.00	33.31	C
ATOM	1895	OD1	ASP	A	248	120.674	64.660	24.689	1.00	34.76	O
ATOM	1896	OD2	ASP	A	248	119.359	64.648	22.922	1.00	33.85	O
ATOM	1897	N	ALA	A	249	116.268	61.487	25.666	1.00	28.79	N
ATOM	1898	CA	ALA	A	249	115.127	61.020	26.439	1.00	28.18	C
ATOM	1899	C	ALA	A	249	114.279	60.097	25.568	1.00	28.88	C
ATOM	1900	O	ALA	A	249	114.314	60.181	24.341	1.00	28.79	O
ATOM	1901	CB	ALA	A	249	114.298	62.209	26.903	1.00	27.25	C
ATOM	1902	N	ILE	A	250	113.543	59.189	26.192	1.00	28.48	N
ATOM	1903	CA	ILE	A	250	112.669	58.324	25.421	1.00	29.55	C
ATOM	1904	C	ILE	A	250	111.260	58.577	25.916	1.00	29.65	C
ATOM	1905	O	ILE	A	250	111.056	58.932	27.085	1.00	29.05	O
ATOM	1906	CB	ILE	A	250	113.000	56.813	25.587	1.00	30.94	C
ATOM	1907	CG1	ILE	A	250	113.023	56.441	27.070	1.00	32.35	C
ATOM	1908	CG2	ILE	A	250	114.303	56.479	24.876	1.00	30.20	C
ATOM	1909	CD1	ILE	A	250	113.296	54.968	27.328	1.00	34.16	C
ATOM	1910	N	VAL	A	251	110.289	58.414	25.024	1.00	29.98	N
ATOM	1911	CA	VAL	A	251	108.894	58.615	25.385	1.00	30.11	C
ATOM	1912	C	VAL	A	251	108.119	57.310	25.254	1.00	31.15	C
ATOM	1913	O	VAL	A	251	107.939	56.777	24.157	1.00	31.33	O
ATOM	1914	CB	VAL	A	251	108.222	59.698	24.499	1.00	29.28	C
ATOM	1915	CG1	VAL	A	251	106.749	59.837	24.869	1.00	28.74	C
ATOM	1916	CG2	VAL	A	251	108.924	61.032	24.689	1.00	28.73	C
ATOM	1917	N	ILE	A	252	107.686	56.791	26.394	1.00	32.25	N
ATOM	1918	CA	ILE	A	252	106.907	55.567	26.445	1.00	34.36	C
ATOM	1919	C	ILE	A	252	105.488	56.052	26.169	1.00	35.92	C
ATOM	1920	O	ILE	A	252	104.796	56.541	27.055	1.00	35.07	O
ATOM	1921	CB	ILE	A	252	107.030	54.933	27.838	1.00	34.93	C
ATOM	1922	CG1	ILE	A	252	108.516	54.658	28.119	1.00	34.36	C
ATOM	1923	CG2	ILE	A	252	106.190	53.662	27.918	1.00	34.35	C
ATOM	1924	CD1	ILE	A	252	108.830	54.276	29.536	1.00	35.76	C
ATOM	1925	N	ASP	A	253	105.084	55.928	24.911	1.00	37.82	N
ATOM	1926	CA	ASP	A	253	103.793	56.405	24.439	1.00	38.30	C
ATOM	1927	C	ASP	A	253	102.759	55.298	24.528	1.00	36.33	C
ATOM	1928	O	ASP	A	253	102.900	54.256	23.897	1.00	35.52	O
ATOM	1929	CB	ASP	A	253	103.969	56.886	22.987	1.00	42.68	C
ATOM	1930	CG	ASP	A	253	103.027	58.024	22.608	1.00	47.26	C
ATOM	1931	OD1	ASP	A	253	103.007	59.059	23.324	1.00	49.54	O
ATOM	1932	OD2	ASP	A	253	102.326	57.895	21.574	1.00	49.50	O
ATOM	1933	N	THR	A	254	101.720	55.535	25.319	1.00	35.67	N
ATOM	1934	CA	THR	A	254	100.654	54.553	25.507	1.00	35.99	C
ATOM	1935	C	THR	A	254	99.267	55.208	25.434	1.00	33.80	C
ATOM	1936	O	THR	A	254	99.115	56.398	25.716	1.00	33.46	O
ATOM	1937	CB	THR	A	254	100.769	53.870	26.894	1.00	37.36	C
ATOM	1938	OG1	THR	A	254	102.127	53.489	27.131	1.00	40.12	O
ATOM	1939	CG2	THR	A	254	99.898	52.617	26.943	1.00	39.58	C
ATOM	1940	N	ALA	A	255	98.257	54.424	25.076	1.00	32.56	N
ATOM	1941	CA	ALA	A	255	96.901	54.943	25.000	1.00	31.89	C
ATOM	1942	C	ALA	A	255	96.381	55.122	26.419	1.00	31.60	C
ATOM	1943	O	ALA	A	255	95.756	56.131	26.743	1.00	31.27	O
ATOM	1944	CB	ALA	A	255	96.021	53.983	24.239	1.00	31.75	C

TABLE 7-continued

ATOM	1945	N	HIS	A	256	96.646	54.133	27.266	1.00	31.05	N
ATOM	1946	CA	HIS	A	256	96.211	54.183	28.652	1.00	30.66	C
ATOM	1947	C	HIS	A	256	97.423	53.961	29.541	1.00	31.22	C
ATOM	1948	O	HIS	A	256	97.811	52.826	29.784	1.00	32.42	O
ATOM	1949	CB	HIS	A	256	95.183	53.092	28.932	1.00	28.92	C
ATOM	1950	CG	HIS	A	256	94.514	53.230	30.263	1.00	28.92	C
ATOM	1951	ND1	HIS	A	256	93.767	52.223	30.832	1.00	29.33	N
ATOM	1952	CD2	HIS	A	256	94.461	54.270	31.128	1.00	28.44	C
ATOM	1953	CB1	HIS	A	256	93.284	52.636	31.991	1.00	29.11	C
ATOM	1954	NE2	HIS	A	256	93.690	53.875	32.194	1.00	29.27	N
ATOM	1955	N	GLY	A	257	98.017	55.043	30.026	1.00	32.56	N
ATOM	1956	CA	GLY	A	257	99.196	54.927	30.871	1.00	33.03	C
ATOM	1957	C	GLY	A	257	98.907	54.494	32.297	1.00	33.73	C
ATOM	1958	O	GLY	A	257	99.825	54.233	33.073	1.00	34.44	O
ATOM	1959	N	HIS	A	258	97.633	54.407	32.655	1.00	33.24	N
ATOM	1960	CA	HIS	A	258	97.277	54.009	34.005	1.00	32.25	C
ATOM	1961	C	HIS	A	258	97.016	52.500	33.995	1.00	33.33	C
ATOM	1962	O	HIS	A	258	96.237	51.991	34.796	1.00	34.50	O
ATOM	1963	CB	HIS	A	258	96.025	54.768	34.447	1.00	30.67	C
ATOM	1964	CG	HIS	A	258	95.892	54.923	35.932	1.00	28.53	C
ATOM	1965	ND1	HIS	A	258	96.576	54.135	36.831	1.00	28.44	N
ATOM	1966	CD2	HIS	A	258	95.100	55.735	36.672	1.00	27.04	C
ATOM	1967	CE1	HIS	A	258	96.212	54.455	38.059	1.00	27.92	C
ATOM	1968	NE2	HIS	A	258	95.316	55.422	37.991	1.00	27.43	N
ATOM	1969	N	SER	A	259	97.664	51.790	33.076	1.00	33.64	N
ATOM	1970	CA	SER	A	259	97.502	50.340	32.974	1.00	35.31	C
ATOM	1971	C	SER	A	259	98.572	49.598	33.765	1.00	35.20	C
ATOM	1972	O	SER	A	259	99.745	49.975	33.751	1.00	35.19	O
ATOM	1973	CB	SER	A	259	97.593	49.883	31.521	1.00	36.71	C
ATOM	1974	OG	SER	A	259	96.600	50.498	30.734	1.00	42.41	O
ATOM	1975	N	ALA	A	260	98.160	48.525	34.434	1.00	35.34	N
ATOM	1976	CA	ALA	A	260	99.075	47.718	35.228	1.00	34.81	C
ATOM	1977	C	ALA	A	260	100.264	47.288	34.377	1.00	34.54	C
ATOM	1978	O	ALA	A	260	101.415	47.394	34.797	1.00	34.57	O
ATOM	1979	CB	ALA	A	260	98.345	46.500	35.769	1.00	34.40	C
ATOM	1980	N	GLY	A	261	99.971	46.808	33.174	1.00	34.40	N
ATOM	1981	CA	GLY	A	261	101.013	46.368	32.271	1.00	33.69	C
ATOM	1982	C	GLY	A	261	102.003	47.458	31.920	1.00	33.68	C
ATOM	1983	O	GLY	A	261	103.211	47.220	31.923	1.00	35.39	O
ATOM	1984	N	VAL	A	262	101.505	48.652	31.612	1.00	31.87	N
ATOM	1985	CA	VAL	A	262	102.372	49.769	31.260	1.00	30.22	C
ATOM	1986	C	VAL	A	262	103.257	50.106	32.453	1.00	30.85	C
ATOM	1987	O	VAL	A	262	104.459	50.296	32.310	1.00	29.76	O
ATOM	1988	CB	VAL	A	262	101.545	51.037	30.851	1.00	29.14	C
ATOM	1989	CG1	VAL	A	262	102.469	52.200	30.517	1.00	25.83	C
ATOM	1990	CG2	VAL	A	262	100.668	50.723	29.653	1.00	28.66	C
ATOM	1991	N	LEU	A	263	102.657	50.170	33.635	1.00	32.42	N
ATOM	1992	CA	LEU	A	263	103.404	50.504	34.842	1.00	35.12	C
ATOM	1993	C	LEU	A	263	104.479	49.449	35.109	1.00	37.28	C
ATOM	1994	O	LEU	A	263	105.579	49.747	35.580	1.00	37.10	O
ATOM	1995	CB	LEU	A	263	102.445	50.611	36.035	1.00	33.85	C
ATOM	1996	CG	LEU	A	263	101.288	51.607	35.876	1.00	32.67	C
ATOM	1997	CD1	LEU	A	263	100.436	51.594	37.126	1.00	31.79	C
ATOM	1998	CD2	LEU	A	263	101.827	53.004	35.615	1.00	31.44	C
ATOM	1999	N	ARG	A	264	104.148	48.208	34.792	1.00	39.38	N
ATOM	2000	CA	ARG	A	264	105.067	47.107	34.981	1.00	41.52	C
ATOM	2001	C	ARG	A	264	106.272	47.304	34.064	1.00	40.90	C
ATOM	2002	O	ARG	A	264	107.410	47.312	34.517	1.00	40.25	O
ATOM	2003	CB	ARG	A	264	104.329	45.804	34.674	1.00	45.25	C
ATOM	2004	CG	ARG	A	264	105.121	44.513	34.813	1.00	50.16	C
ATOM	2005	CD	ARG	A	264	104.144	43.343	34.780	1.00	53.35	C
ATOM	2006	NE	ARG	A	264	103.248	43.420	33.626	1.00	56.71	N
ATOM	2007	CZ	ARG	A	264	102.152	42.681	33.479	1.00	58.23	C
ATOM	2008	NH1	ARG	A	264	101.810	41.805	34.416	1.00	60.06	N
ATOM	2009	NH2	ARG	A	264	101.390	42.821	32.402	1.00	58.84	N
ATOM	2010	N	LYS	A	265	106.010	47.486	32.776	1.00	40.84	N
ATOM	2011	CA	LYS	A	265	107.068	47.684	31.795	1.00	41.03	C
ATOM	2012	C	LYS	A	265	107.915	48.928	32.068	1.00	41.03	C
ATOM	2013	O	LYS	A	265	109.130	48.909	31.885	1.00	42.30	O
ATOM	2014	CB	LYS	A	265	106.461	47.762	30.390	1.00	41.68	C
ATOM	2015	CG	LYS	A	265	107.441	48.146	29.293	1.00	43.10	C
ATOM	2016	CD	LYS	A	265	108.624	47.198	29.235	1.00	45.73	C
ATOM	2017	CE	LYS	A	265	108.175	45.761	29.019	1.00	47.46	C
ATOM	2018	NZ	LYS	A	265	107.382	45.593	27.771	1.00	48.86	N
ATOM	2019	N	ILE	A	266	107.278	50.009	32.504	1.00	40.38	N
ATOM	2020	CA	ILE	A	266	107.999	51.244	32.783	1.00	39.51	C
ATOM	2021	C	ILE	A	266	108.989	51.061	33.920	1.00	40.45	C
ATOM	2022	O	ILE	A	266	110.124	51.549	33.856	1.00	40.08	O
ATOM	2023	CB	ILE	A	266	107.028	52.396	33.134	1.00	38.28	C

TABLE 7-continued

ATOM	2024	CG1	ILE	A	266	106.249	52.809	31.887	1.00	36.55	C
ATOM	2025	CG2	ILE	A	266	107.795	53.572	33.704	1.00	37.78	C
ATOM	2026	CD1	ILE	A	266	105.333	53.963	32.111	1.00	36.83	C
ATOM	2027	N	ALA	A	267	108.553	50.359	34.962	1.00	41.07	N
ATOM	2028	CA	ALA	A	267	109.404	50.105	36.117	1.00	41.67	C
ATOM	2029	C	ALA	A	267	110.584	49.260	35.672	1.00	42.17	C
ATOM	2030	O	ALA	A	267	111.704	49.453	36.141	1.00	42.01	O
ATOM	2031	CB	ALA	A	267	108.621	49.386	37.200	1.00	41.62	C
ATOM	2032	N	GLU	A	268	110.330	48.330	34.757	1.00	42.65	N
ATOM	2033	CA	GLU	A	268	111.386	47.470	34.246	1.00	44.51	C
ATOM	2034	C	GLU	A	268	112.334	48.294	33.383	1.00	44.45	C
ATOM	2035	O	GLU	A	268	113.548	48.064	33.382	1.00	45.38	O
ATOM	2036	CB	GLU	A	268	110.790	46.321	33.429	1.00	46.13	C
ATOM	2037	CG	GLU	A	268	109.741	45.530	34.195	1.00	50.26	C
ATOM	2038	CD	GLU	A	268	109.164	44.377	33.394	1.00	52.59	C
ATOM	2039	OE1	GLU	A	268	108.776	44.587	32.222	1.00	53.91	O
ATOM	2040	OE2	GLU	A	268	109.080	43.260	33.947	1.00	54.82	O
ATOM	2041	N	ILE	A	269	111.780	49.256	32.649	1.00	43.95	N
ATOM	2042	CA	ILE	A	269	112.591	50.117	31.799	1.00	43.12	C
ATOM	2043	C	ILE	A	269	113.450	51.012	32.688	1.00	42.99	C
ATOM	2044	O	ILE	A	269	114.627	51.236	32.402	1.00	42.66	O
ATOM	2045	CB	ILE	A	269	111.716	51.001	30.881	1.00	42.99	C
ATOM	2046	CG1	ILE	A	269	110.944	50.122	29.896	1.00	42.46	C
ATOM	2047	CG2	ILE	A	269	112.590	51.995	30.123	1.00	42.46	C
ATOM	2048	CD1	ILE	A	269	110.036	50.898	38.968	1.00	41.32	C
ATOM	2049	N	ARG	A	270	112.859	51.519	33.768	1.00	42.35	N
ATOM	2050	CA	ARG	A	270	113.592	52.372	34.696	1.00	42.43	C
ATOM	2051	C	ARG	A	270	114.667	51.580	35.447	1.00	43.30	C
ATOM	2052	O	ARG	A	270	115.802	52.033	35.598	1.00	42.17	O
ATOM	2053	CB	ARG	A	270	112.630	53.026	35.689	1.00	40.28	C
ATOM	2054	CG	ARG	A	270	113.335	53.693	36.857	1.00	40.08	C
ATOM	2055	CD	ARG	A	270	114.401	54.661	36.381	1.00	39.52	C
ATOM	2056	NE	ARG	A	270	113.843	55.890	35.835	1.00	39.63	N
ATOM	2057	CZ	ARG	A	270	114.568	56.833	35.246	1.00	40.17	C
ATOM	2058	NH1	ARG	A	270	115.879	56.682	35.127	1.00	39.75	N
ATOM	2059	NH2	ARG	A	270	113.991	57.941	34.803	1.00	41.04	N
ATOM	2060	N	ALA	A	271	114.297	50.393	35.917	1.00	44.99	N
ATOM	2061	CA	ALA	A	271	115.224	49.538	36.638	1.00	46.51	C
ATOM	2062	C	ALA	A	271	116.445	49.281	35.766	1.00	47.60	C
ATOM	2063	O	ALA	A	271	117.550	49.086	36.272	1.00	49.90	O
ATOM	2064	CB	ALA	A	271	114.555	48.222	36.998	1.00	46.57	C
ATOM	2065	N	HIS	A	272	116.254	49.283	34.454	1.00	47.42	N
ATOM	2066	CA	HIS	A	272	117.368	49.048	33.559	1.00	47.00	C
ATOM	2067	C	HIS	A	272	118.096	50.347	33.204	1.00	46.88	C
ATOM	2068	O	HIS	A	272	119.308	50.339	33.009	1.00	47.71	O
ATOM	2069	CB	HIS	A	272	116.889	48.341	32.295	1.00	47.98	C
ATOM	2070	CG	HIS	A	272	117.999	47.783	31.461	1.00	50.44	C
ATOM	2071	ND1	HIS	A	272	117.779	47.130	30.269	1.00	51.34	N
ATOM	2072	CD2	HIS	A	272	119.341	47.762	31.658	1.00	51.66	C
ATOM	2073	CE1	HIS	A	272	118.935	46.730	29.767	1.00	52.07	C
ATOM	2074	NE2	HIS	A	272	119.899	47.101	30.591	1.00	51.04	N
ATOM	2075	N	PHE	A	273	117.370	51.462	33.124	1.00	46.29	N
ATOM	2076	CA	PHE	A	273	117.991	52.755	32.806	1.00	45.64	C
ATOM	2077	C	PHE	A	273	117.810	53.752	33.954	1.00	46.32	C
ATOM	2078	O	PHE	A	273	117.128	54.770	33.797	1.00	47.02	O
ATOM	2079	CB	PHE	A	273	117.386	53.378	31.541	1.00	43.67	C
ATOM	2080	CG	PHE	A	273	117.491	52.519	30.313	1.00	42.54	C
ATOM	2081	CD1	PHE	A	273	116.589	51.489	30.088	1.00	42.71	C
ATOM	2082	CD2	PHE	A	273	118.485	52.755	29.370	1.00	42.26	C
ATOM	2083	CE1	PHE	A	273	116.673	50.709	28.933	1.00	43.23	C
ATOM	2084	CE2	PHE	A	273	118.580	51.981	28.217	1.00	41.40	C
ATOM	2085	CZ	PHE	A	273	117.673	50.959	27.996	1.00	42.59	C
ATOM	2086	N	PRO	A	274	118.431	53.483	35.116	1.00	45.94	N
ATOM	2087	CA	PRO	A	274	118.355	54.329	36.313	1.00	45.40	C
ATOM	2088	C	PRO	A	274	118.763	55.799	36.194	1.00	45.24	C
ATOM	2089	O	PRO	A	274	118.347	56.614	37.011	1.00	45.24	O
ATOM	2090	CB	PRO	A	274	119.229	53.571	37.308	1.00	44.99	C
ATOM	2091	CG	PRO	A	274	120.244	52.905	36.395	1.00	44.50	C
ATOM	2092	CD	PRO	A	274	119.283	52.317	35.400	1.00	45.59	C
ATOM	2093	N	ASN	A	275	119.566	56.145	35.195	1.00	45.09	N
ATOM	2094	CA	ASN	A	275	120.015	57.527	35.042	1.00	45.14	C
ATOM	2095	C	ASN	A	275	119.229	58.295	33.977	1.00	44.49	C
ATOM	2096	O	ASN	A	275	118.967	59.487	34.126	1.00	45.55	O
ATOM	2097	CB	ASN	A	275	121.497	57.563	34.664	1.00	47.44	C
ATOM	2098	CG	ASN	A	275	122.370	56.762	35.614	1.00	49.31	C
ATOM	2099	OD1	ASN	A	275	122.481	57.076	36.795	1.00	49.47	O
ATOM	2100	ND2	ASN	A	275	123.000	55.713	35.090	1.00	51.15	N
ATOM	2101	N	ARG	A	276	118.869	57.600	32.903	1.00	41.92	N
ATOM	2102	CA	ARG	A	276	118.143	58.183	31.782	1.00	39.15	C

TABLE 7-continued

ATOM	2103	C	ARG	A	276	116.868	58.946	32.148	1.00	37.69	C
ATOM	2104	O	ARG	A	276	116.276	58.729	33.206	1.00	37.58	O
ATOM	2105	CB	ARG	A	276	117.793	57.080	30.791	1.00	39.18	C
ATOM	2106	CG	ARG	A	276	118.985	56.271	30.302	1.00	37.60	C
ATOM	2107	CD	ARG	A	276	119.955	57.089	29.463	1.00	36.19	C
ATOM	2108	NE	ARG	A	276	121.019	56.235	28.938	1.00	35.76	N
ATOM	2109	CZ	ARG	A	276	121.913	56.609	28.031	1.00	35.25	C
ATOM	2110	NH1	ARG	A	276	121.887	57.836	27.531	1.00	36.02	N
ATOM	2111	NH2	ARG	A	276	122.831	55.750	27.617	1.00	36.01	N
ATOM	2112	N	THR	A	277	116.461	59.846	31.254	1.00	35.95	N
ATOM	2113	CA	THR	A	277	115.251	60.654	31.429	1.00	33.86	C
ATOM	2114	C	THR	A	277	114.086	59.917	30.790	1.00	32.47	C
ATOM	2115	O	THR	A	277	114.108	59.638	29.587	1.00	31.01	O
ATOM	2116	CB	THR	A	277	115.369	62.023	30.728	1.00	33.80	C
ATOM	2117	OG1	THR	A	277	116.362	62.822	31.381	1.00	34.95	O
ATOM	2118	CG2	THR	A	277	114.039	62.746	30.753	1.00	33.78	C
ATOM	2119	N	LEU	A	278	113.073	59.602	31.588	1.00	30.23	N
ATOM	2120	CA	LEU	A	278	111.915	58.889	31.070	1.00	29.28	C
ATOM	2121	C	LEU	A	278	110.663	59.754	31.048	1.00	28.27	C
ATOM	2122	O	LEU	A	278	110.329	60.404	32.032	1.00	27.31	O
ATOM	2123	CB	LEU	A	278	111.649	57.628	31.893	1.00	28.56	C
ATOM	2124	CG	LEU	A	278	112.782	56.600	31.915	1.00	29.99	C
ATOM	2125	CD1	LEU	A	278	112.339	55.362	32.692	1.00	29.20	C
ATOM	2126	CD2	LEU	A	278	113.159	56.217	30.486	1.00	30.32	C
ATOM	2127	N	ILE	A	279	109.993	59.766	29.900	1.00	26.83	N
ATOM	2128	CA	ILE	A	279	108.759	60.517	29.713	1.00	25.75	C
ATOM	2129	C	ILE	A	279	107.756	59.403	29.451	1.00	26.77	C
ATOM	2130	O	ILE	A	279	108.035	58.499	28.649	1.00	25.38	O
ATOM	2131	CB	ILE	A	279	108.847	61.448	28.485	1.00	23.44	C
ATOM	2132	CG1	ILE	A	279	110.078	62.345	28.598	1.00	23.15	C
ATOM	2133	CG2	ILE	A	279	107.604	62.310	28.405	1.00	24.07	C
ATOM	2134	CD1	ILE	A	279	110.295	63.233	27.412	1.00	23.91	C
ATOM	2135	N	ALA	A	280	106.596	59.449	30.100	1.00	27.48	N
ATOM	2136	CA	ALA	A	280	105.657	58.354	29.914	1.00	30.73	C
ATOM	2137	C	ALA	A	280	104.246	58.667	29.469	1.00	32.08	C
ATOM	2138	O	ALA	A	280	103.726	59.745	29.725	1.00	31.46	O
ATOM	2139	CB	ALA	A	280	105.608	57.495	31.182	1.00	30.65	C
ATOM	2140	N	GLY	A	281	103.665	57.644	28.829	1.00	35.24	N
ATOM	2141	CA	GLY	A	281	102.314	57.614	28.273	1.00	35.20	C
ATOM	2142	C	GLY	A	281	101.303	58.614	28.763	1.00	35.43	C
ATOM	2143	O	GLY	A	281	101.623	59.501	29.552	1.00	37.45	O
ATOM	2144	N	ASN	A	282	100.057	58.467	28.325	1.00	32.74	N
ATOM	2145	CA	ASN	A	282	99.063	59.443	28.729	1.00	29.41	C
ATOM	2146	C	ASN	A	282	98.088	59.056	29.815	1.00	27.37	C
ATOM	2147	O	ASN	A	282	97.590	57.933	29.882	1.00	26.60	O
ATOM	2148	CB	ASN	A	282	98.318	59.939	27.491	1.00	30.24	C
ATOM	2149	CG	ASN	A	282	99.200	60.807	26.595	1.00	31.84	C
ATOM	2150	OD1	ASN	A	282	100.405	60.562	26.467	1.00	32.15	O
ATOM	2151	ND2	ASN	A	282	98.600	61.809	25.949	1.00	32.17	N
ATOM	2152	N	ILE	A	283	97.845	60.019	30.690	1.00	25.51	N
ATOM	2153	CA	ILE	A	283	96.907	59.873	31.790	1.00	24.37	C
ATOM	2154	C	ILE	A	283	96.136	61.185	31.823	1.00	23.61	C
ATOM	2155	O	ILE	A	283	96.532	62.160	31.175	1.00	23.14	O
ATOM	2156	CB	ILE	A	283	97.636	59.631	33.150	1.00	23.62	C
ATOM	2157	CG1	ILE	A	283	98.677	60.727	33.421	1.00	22.08	C
ATOM	2158	CG2	ILE	A	283	98.279	58.256	33.153	1.00	23.25	C
ATOM	2159	CD1	ILE	A	283	98.119	62.094	33.881	1.00	19.86	C
ATOM	2160	N	ALA	A	284	95.039	61.216	32.561	1.00	22.29	N
ATOM	2161	CA	ALA	A	284	94.254	62.426	32.639	1.00	23.16	C
ATOM	2162	C	ALA	A	284	93.744	62.633	34.059	1.00	24.19	C
ATOM	2163	O	ALA	A	284	92.839	63.434	34.300	1.00	25.24	O
ATOM	2164	CB	ALA	A	284	93.102	62.347	31.659	1.00	22.62	C
ATOM	2165	N	THR	A	285	94.341	61.914	35.004	1.00	25.00	N
ATOM	2166	CA	THR	A	285	93.936	62.015	36.403	1.00	25.00	C
ATOM	2167	C	THR	A	285	95.149	62.180	37.308	1.00	24.68	C
ATOM	2168	O	THR	A	285	96.282	61.956	36.889	1.00	22.17	O
ATOM	2169	CB	THR	A	285	93.176	60.759	36.851	1.00	24.60	C
ATOM	2170	OG1	THR	A	285	94.056	59.636	36.784	1.00	27.11	O
ATOM	2171	CG2	THR	A	285	91.975	60.501	35.953	1.00	23.14	C
ATOM	2172	N	ALA	A	286	94.893	62.576	38.555	1.00	25.97	N
ATOM	2173	CA	ALA	A	286	95.951	62.766	39.536	1.00	26.48	C
ATOM	2174	C	ALA	A	286	96.580	61.422	39.897	1.00	28.07	C
ATOM	2175	O	ALA	A	286	97.800	61.329	40.057	1.00	29.78	O
ATOM	2176	CB	ALA	A	286	95.395	63.445	40.783	1.00	24.43	C
ATOM	2177	N	GLU	A	287	95.763	60.378	40.022	1.00	29.47	N
ATOM	2178	CA	GLU	A	287	96.295	59.058	40.354	1.00	30.99	C
ATOM	2179	C	GLU	A	287	97.131	58.451	39.242	1.00	29.83	C
ATOM	2180	O	GLU	A	287	98.109	57.744	39.505	1.00	29.81	O
ATOM	2181	CB	GLU	A	287	95.173	58.094	40.739	1.00	33.93	C

TABLE 7-continued

ATOM	2182	CG	GLU	A	287	95.052	57.909	42.255	1.00	41.21	C
ATOM	2183	CD	GLU	A	287	96.298	57.259	42.899	1.00	44.34	C
ATOM	2184	OE1	GLU	A	287	96.319	57.141	44.147	1.00	45.00	O
ATOM	2185	OE2	GLU	A	287	97.244	56.861	42.165	1.00	44.45	O
ATOM	2186	N	GLY	A	288	96.746	58.726	38.000	1.00	28.61	N
ATOM	2187	CA	GLY	A	288	97.495	58.204	36.876	1.00	26.94	C
ATOM	2188	C	GLY	A	288	98.879	58.818	36.848	1.00	26.38	C
ATOM	2189	O	GLY	A	288	99.849	58.139	36.556	1.00	26.76	O
ATOM	2190	N	ALA	A	289	98.974	60.109	37.150	1.00	26.64	N
ATOM	2191	CA	ALA	A	289	100.257	60.793	37.156	1.00	27.29	C
ATOM	2192	C	ALA	A	289	101.087	60.229	38.296	1.00	29.11	C
ATOM	2193	O	ALA	A	289	102.293	60.013	38.159	1.00	30.09	O
ATOM	2194	CB	ALA	A	289	100.052	62.277	37.348	1.00	27.03	C
ATOM	2195	N	ARG	A	290	100.428	59.983	39.423	1.00	29.67	N
ATOM	2196	CA	ARG	A	290	101.091	59.433	40.600	1.00	30.07	C
ATOM	2197	C	ARG	A	290	101.598	58.009	40.327	1.00	29.70	C
ATOM	2198	O	ARG	A	290	102.729	57.656	40.687	1.00	30.10	O
ATOM	2199	CB	ARG	A	290	100.123	59.463	41.783	1.00	29.78	C
ATOM	2200	CG	ARG	A	290	100.653	58.884	43.073	1.00	31.76	C
ATOM	2201	CD	ARG	A	290	99.694	59.214	44.205	1.00	34.18	C
ATOM	2202	NE	ARG	A	290	99.812	60.610	44.623	1.00	37.25	N
ATOM	2203	CZ	ARG	A	290	98.786	61.440	44.789	1.00	38.76	C
ATOM	2204	NH1	ARG	A	290	97.544	61.019	44.567	1.00	41.18	N
ATOM	2205	NH2	ARG	A	290	99.001	62.685	45.195	1.00	38.72	N
ATOM	2206	N	ALA	A	291	100.774	57.194	39.673	1.00	28.72	N
ATOM	2207	CA	ALA	A	291	101.176	55.829	39.356	1.00	26.94	C
ATOM	2208	C	ALA	A	291	102.425	55.850	38.476	1.00	26.66	C
ATOM	2209	O	ALA	A	291	103.363	55.092	38.700	1.00	27.57	O
ATOM	2210	CB	ALA	A	291	100.041	55.096	38.649	1.00	24.83	C
ATOM	2211	N	LEU	A	292	102.437	56.723	37.473	1.00	26.41	N
ATOM	2212	CA	LEU	A	292	103.579	56.823	36.570	1.00	26.25	C
ATOM	2213	C	LEU	A	292	104.823	57.369	37.272	1.00	26.35	C
ATOM	2214	O	LEU	A	292	105.927	56.861	37.069	1.00	25.85	O
ATOM	2215	CB	LEU	A	292	103.221	57.688	35.356	1.00	25.03	C
ATOM	2216	CG	LEU	A	292	102.247	57.053	34.351	1.00	24.67	C
ATOM	2217	CD1	LEU	A	292	101.748	58.098	33.353	1.00	24.62	C
ATOM	2218	CD2	LEU	A	292	102.943	55.909	33.634	1.00	21.45	C
ATOM	2219	N	TYR	A	293	104.661	58.408	38.083	1.00	27.07	N
ATOM	2220	CA	TYR	A	293	105.809	58.947	38.804	1.00	28.43	C
ATOM	2221	C	TYR	A	293	106.353	57.853	39.710	1.00	29.43	C
ATOM	2222	O	TYR	A	293	107.555	57.601	39.738	1.00	29.87	O
ATOM	2223	CB	TYR	A	293	105.398	60.155	39.629	1.00	28.36	C
ATOM	2224	CG	TYR	A	293	105.192	61.411	38.812	1.00	29.78	C
ATOM	2225	CD1	TYR	A	293	104.175	62.310	39.134	1.00	29.30	C
ATOM	2226	CD2	TYR	A	293	106.038	61.725	37.744	1.00	29.08	C
ATOM	2227	CE1	TYR	A	293	104.000	63.485	38.417	1.00	28.70	C
ATOM	2228	CE2	TYR	A	293	105.868	62.905	37.020	1.00	28.90	C
ATOM	2229	CZ	TYR	A	293	104.844	63.776	37.367	1.00	28.75	C
ATOM	2230	OH	TYR	A	293	104.644	64.936	36.666	1.00	29.75	O
ATOM	2231	N	ASP	A	294	105.456	57.191	40.435	1.00	30.73	N
ATOM	2232	CA	ASP	A	294	105.846	56.104	41.325	1.00	32.03	C
ATOM	2233	C	ASP	A	294	106.533	54.961	40.573	1.00	33.10	C
ATOM	2234	O	ASP	A	294	107.287	54.185	41.167	1.00	34.97	O
ATOM	2235	CB	ASP	A	294	104.623	55.570	42.067	1.00	31.61	C
ATOM	2236	CG	ASP	A	294	104.081	56.554	43.080	1.00	32.26	C
ATOM	2237	OD1	ASP	A	294	103.034	56.266	43.700	1.00	33.58	O
ATOM	2238	OD2	ASP	A	294	104.704	57.615	43.267	1.00	32.44	O
ATOM	2239	N	ALA	A	295	106.275	54.854	39.271	1.00	32.83	N
ATOM	2240	CA	ALA	A	295	106.879	53.802	38.455	1.00	31.74	C
ATOM	2241	C	ALA	A	295	108.264	54.224	37.992	1.00	31.68	C
ATOM	2242	O	ALA	A	295	108.985	53.436	37.380	1.00	32.56	O
ATOM	2243	CB	ALA	A	295	105.997	53.482	37.251	1.00	30.93	C
ATOM	2244	N	GLY	A	296	108.630	55.470	38.269	1.00	30.95	N
ATOM	2245	CA	GLY	A	296	109.948	55.933	37.882	1.00	31.13	C
ATOM	2246	C	GLY	A	296	110.045	56.900	36.717	1.00	31.66	C
ATOM	2247	O	GLY	A	296	111.149	57.204	36.265	1.00	31.91	O
ATOM	2248	N	VAL	A	297	108.919	57.394	36.219	1.00	31.67	N
ATOM	2249	CA	VAL	A	297	108.978	58.328	35.101	1.00	31.83	C
ATOM	2250	C	VAL	A	297	109.416	59.716	35.586	1.00	29.98	C
ATOM	2251	O	VAL	A	297	109.171	60.092	36.730	1.00	29.21	O
ATOM	2252	CB	VAL	A	297	107.606	58.445	34.382	1.00	32.91	C
ATOM	2253	CG1	VAL	A	297	106.596	59.096	35.290	1.00	35.68	C
ATOM	2254	CG2	VAL	A	297	107.747	59.266	33.125	1.00	35.70	C
ATOM	2255	N	ASP	A	298	110.074	60.463	34.707	1.00	28.22	N
ATOM	2256	CA	ASP	A	298	110.545	61.801	35.022	1.00	27.00	C
ATOM	2257	C	ASP	A	298	109.528	62.852	34.607	1.00	27.20	C
ATOM	2258	O	ASP	A	298	109.281	63.813	35.332	1.00	26.86	O
ATOM	2259	CB	ASP	A	298	111.870	62.071	34.309	1.00	28.58	C
ATOM	2260	CG	ASP	A	298	112.974	61.149	34.776	1.00	30.31	C

TABLE 7-continued

ATOM	2261	OD1	ASP	A	298	113.221	61.114	35.994	1.00	34.37	O
ATOM	2262	OD2	ASP	A	298	113.600	60.462	33.943	1.00	31.52	O
ATOM	2263	N	VAL	A	299	108.942	62.664	33.430	1.00	26.94	N
ATOM	2264	CA	VAL	A	299	107.955	63.596	32.898	1.00	25.40	C
ATOM	2265	C	VAL	A	299	106.704	62.825	32.462	1.00	24.71	C
ATOM	2266	O	VAL	A	299	106.792	61.831	31.736	1.00	24.19	O
ATOM	2267	CB	VAL	A	299	108.526	64.371	31.667	1.00	25.18	C
ATOM	2268	CG1	VAL	A	299	107.573	65.493	31.255	1.00	23.30	C
ATOM	2269	CG2	VAL	A	299	109.908	64.920	31.985	1.00	24.81	C
ATOM	2270	N	VAL	A	300	105.544	63.287	32.916	1.00	23.99	N
ATOM	2271	CA	VAL	A	300	104.270	62.661	32.576	1.00	23.71	C
ATOM	2272	C	VAL	A	300	103.499	63.493	31.555	1.00	24.32	C
ATOM	2273	O	VAL	A	300	103.338	64.707	31.730	1.00	24.20	O
ATOM	2274	CB	VAL	A	300	103.370	62.486	33.825	1.00	23.42	C
ATOM	2275	CG1	VAL	A	300	101.967	62.116	33.407	1.00	23.29	C
ATOM	2276	CG2	VAL	A	300	103.923	61.391	34.722	1.00	23.23	C
ATOM	2277	N	LYS	A	301	103.033	62.854	30.484	1.00	24.40	N
ATOM	2278	CA	LYS	A	301	102.258	63.588	29.503	1.00	24.04	C
ATOM	2279	C	LYS	A	301	100.782	63.356	29.753	1.00	22.78	C
ATOM	2280	O	LYS	A	301	100.322	62.229	29.960	1.00	21.52	O
ATOM	2281	CB	LYS	A	301	102.686	63.259	28.065	1.00	24.29	C
ATOM	2282	CG	LYS	A	301	102.809	61.818	27.709	1.00	29.51	C
ATOM	2283	CD	LYS	A	301	103.757	61.674	26.489	1.00	32.99	C
ATOM	2284	CE	LYS	A	301	103.228	62.284	25.187	1.00	30.67	C
ATOM	2285	NZ	LYS	A	301	102.178	61.439	24.564	1.00	30.01	N
ATOM	2286	N	VAL	A	302	100.060	64.470	29.782	1.00	22.18	N
ATOM	2287	CA	VAL	A	302	98.641	64.485	30.061	1.00	22.10	C
ATOM	2289	C	VAL	A	302	97.793	64.628	28.807	1.00	22.59	C
ATOM	2289	O	VAL	A	302	98.082	65.457	27.938	1.00	22.52	O
ATOM	2290	CB	VAL	A	302	98.306	65.652	31.032	1.00	21.25	C
ATOM	2291	CG1	VAL	A	302	96.815	65.677	31.335	1.00	20.58	C
ATOM	2292	CG2	VAL	A	302	99.103	65.504	32.312	1.00	20.42	C
ATOM	2293	N	GLY	A	303	96.745	63.812	28.722	1.00	22.97	N
ATOM	2294	CA	GLY	A	303	95.854	63.892	27.582	1.00	22.25	C
ATOM	2295	C	GLY	A	303	95.160	62.618	27.153	1.00	22.34	C
ATOM	2296	O	GLY	A	303	95.784	61.750	26.566	1.00	23.71	O
ATOM	2297	N	ILE	A	304	93.873	62.493	27.453	1.00	22.67	N
ATOM	2298	CA	ILE	A	304	93.107	61.329	27.011	1.00	24.68	C
ATOM	2299	C	ILE	A	304	91.883	61.799	26.202	1.00	26.38	C
ATOM	2300	O	ILE	A	304	90.881	62.237	26.770	1.00	26.11	O
ATOM	2301	CB	ILE	A	304	92.625	60.446	28.195	1.00	23.24	C
ATOM	2302	CG1	ILE	A	304	93.818	59.799	28.906	1.00	22.41	C
ATOM	2303	CG2	ILE	A	304	91.711	59.346	27.680	1.00	21.36	C
ATOM	2304	CD1	ILE	A	304	94.503	56.718	28.113	1.00	22.43	C
ATOM	2305	N	GLY	A	305	91.996	61.747	24.872	1.00	28.56	N
ATOM	2306	CA	GLY	A	305	90.895	62.138	24.011	1.00	30.63	C
ATOM	2307	C	GLY	A	305	90.843	63.516	23.356	1.00	33.34	C
ATOM	2308	O	GLY	A	305	90.112	63.666	22.370	1.00	34.88	O
ATOM	2309	N	PRO	A	306	91.588	64.534	23.836	1.00	33.14	N
ATOM	2310	CA	PRO	A	306	91.541	65.875	23.226	1.00	33.01	C
ATOM	2311	C	PRO	A	306	92.126	66.054	21.814	1.00	33.06	C
ATOM	2312	O	PRO	A	306	91.928	67.104	21.191	1.00	33.29	O
ATO	2313	CB	PRO	A	306	92.275	66.728	24.256	1.00	30.93	C
ATOM	2314	CG	PRO	A	306	93.353	65.772	24.704	1.00	30.96	C
ATOM	2315	CD	PRO	A	306	92.504	64.547	24.992	1.00	31.97	C
ATOM	2316	N	GLY	A	307	92.833	65.044	21.313	1.00	33.26	N
ATOM	2317	CA	GLY	A	307	93.446	65.148	19.994	1.00	33.13	C
ATOM	2318	C	GLY	A	307	92.525	65.502	18.837	1.00	33.48	C
ATOM	2319	O	GLY	A	307	91.414	64.982	16.739	1.00	33.64	O
ATOM	2320	N	SER	A	308	92.992	66.382	17.950	1.00	32.89	N
ATOM	2321	CA	SER	A	308	92.209	66.802	16.783	1.00	33.08	C
ATOM	2322	C	SER	A	308	91.745	65.606	15.950	1.00	32.80	C
ATOM	2323	O	SER	A	308	90.623	65.577	15.452	1.00	33.12	O
ATOM	2324	CB	SER	A	308	93.038	67.743	15.898	1.00	32.26	C
ATOM	2325	OG	SER	A	308	94.229	67.114	15.448	1.00	31.53	O
ATOM	2326	N	ILE	A	309	92.625	64.625	15.809	1.00	33.27	N
ATOM	2327	CA	ILE	A	309	92.346	63.416	15.045	1.00	34.38	C
ATOM	2328	C	ILE	A	309	91.953	62.229	15.940	1.00	34.76	C
ATOM	2329	O	ILE	A	309	91.843	61.095	15.471	1.00	34.40	O
ATOM	2330	CB	ILE	A	309	93.590	63.033	14.176	1.00	35.31	C
ATOM	2331	CG1	ILE	A	309	94.878	63.132	15.004	1.00	35.26	C
ATOM	2332	CG2	ILE	A	309	93.709	63.974	12.980	1.00	34.04	C
ATOM	2333	CD1	ILE	A	309	94.957	62.199	16.191	1.00	36.80	C
ATOM	2334	N	CYS	A	310	91.743	62.506	17.227	1.00	35.32	N
ATOM	2335	CA	CYS	A	310	91.380	61.483	18.209	1.00	35.11	C
ATOM	2336	C	CYS	A	310	89.882	61.214	18.337	1.00	34.44	C
ATOM	2337	O	CYS	A	310	89.072	62.142	18.449	1.00	33.70	O
ATOM	2338	CB	CYS	A	310	91.922	61.873	19.587	1.00	36.64	C
ATOM	2339	SG	CYS	A	310	91.351	60.810	20.950	1.00	40.34	S

TABLE 7-continued

ATOM	2340	N	THR	A	311	89.529	59.931	18.351	1.00	33.48	N
ATOM	2341	CA	THR	A	311	88.143	59.500	18.487	1.00	33.03	C
ATOM	2342	C	THR	A	311	87.936	58.662	19.756	1.00	31.85	C
ATOM	2343	O	THR	A	311	86.911	58.016	19.924	1.00	32.55	O
ATOM	2344	CB	THR	A	311	87.720	58.657	17.287	1.00	34.00	C
ATOM	2345	OG1	THR	A	311	88.594	57.526	17.180	1.00	36.60	O
ATOM	2346	CG2	THR	A	311	87.797	59.474	16.004	1.00	34.76	C
ATOM	2347	N	THR	A	312	88.912	58.667	20.650	1.00	30.55	N
ATOM	2348	CA	THR	A	312	88.794	57.905	21.884	1.00	29.18	C
ATOM	2349	C	THR	A	312	87.523	58.238	22.661	1.00	28.00	C
ATOM	2350	O	THR	A	312	86.831	57.344	23.144	1.00	27.47	O
ATOM	2351	CB	THR	A	312	90.018	58.142	22.783	1.00	29.25	C
ATOM	2352	OG1	THR	A	312	91.174	57.572	22.159	1.00	31.01	O
ATOM	2353	CG2	THR	A	312	89.821	57.509	24.150	1.00	30.17	C
ATOM	2354	N	ARG	A	313	87.199	59.518	22.774	1.00	26.42	N
ATOM	2355	CA	ARG	A	313	86.015	59.899	23.519	1.00	26.82	C
ATOM	2356	C	ARG	A	313	84.712	59.469	22.858	1.00	27.41	C
ATOM	2357	O	ARG	A	313	83.699	59.237	23.531	1.00	28.22	O
ATOM	2358	CB	ARG	A	313	86.025	61.407	23.765	1.00	27.23	C
ATOM	2359	CG	ARG	A	313	87.207	61.837	24.616	1.00	28.90	C
ATOM	2360	CD	ARG	A	313	87.183	63.318	24.904	1.00	31.11	C
ATOM	2361	NE	ARG	A	313	88.414	63.773	25.552	1.00	32.48	N
ATOM	2362	CZ	ARG	A	313	88.674	65.046	25.840	1.00	32.07	C
ATOM	2363	NH1	ARG	A	313	87.790	65.996	25.540	1.00	30.54	N
ATOM	2364	NH2	ARG	A	313	89.817	65.366	26.430	1.00	31.87	N
ATOM	2365	N	VAL	A	314	84.746	59.339	21.540	1.00	26.45	N
ATOM	2366	CA	VAL	A	314	83.576	58.952	20.774	1.00	25.00	C
ATOM	2367	C	VAL	A	314	83.364	57.446	20.698	1.00	24.59	C
ATOM	2368	O	VAL	A	314	82.253	56.963	20.890	1.00	24.29	O
ATOM	2369	CB	VAL	A	314	83.672	59.496	19.338	1.00	26.31	C
ATOM	2370	CG1	VAL	A	314	82.429	59.127	18.558	1.00	26.03	C
ATOM	2371	CG2	VAL	A	314	83.866	60.998	19.371	1.00	25.74	C
ATOM	2372	N	VAL	A	315	84.428	56.704	20.416	1.00	24.12	N
ATOM	2373	CA	VAL	A	315	84.322	55.255	20.286	1.00	24.14	C
ATOM	2374	C	VAL	A	315	84.419	54.460	21.595	1.00	23.17	C
ATOM	2375	O	VAL	A	315	83.837	53.387	21.713	1.00	22.34	O
ATOM	2376	CB	VAL	A	315	85.351	54.737	19.266	1.00	23.99	C
ATOM	2377	CG1	VAL	A	315	85.058	55.352	17.897	1.00	24.71	C
ATOM	2378	CG2	VAL	A	315	86.754	55.099	19.705	1.00	25.41	C
ATOM	2379	N	ALA	A	316	85.137	54.992	22.577	1.00	22.80	N
ATOM	2380	CA	ALA	A	316	85.273	54.322	23.864	1.00	22.89	C
ATOM	2381	C	ALA	A	316	84.453	55.075	24.907	1.00	23.76	C
ATOM	2382	O	ALA	A	316	84.096	54.525	25.955	1.00	23.93	O
ATOM	2383	CB	ALA	A	316	86.739	54.277	24.278	1.00	21.84	C
ATOM	2384	N	GLY	A	317	84.154	56.337	24.607	1.00	24.54	N
ATOM	2385	CA	GLY	A	317	83.378	57.167	25.511	1.00	24.66	C
ATOM	2386	C	GLY	A	317	84.154	57.582	26.744	1.00	25.96	C
ATOM	2387	O	GLY	A	317	83.558	57.954	27.759	1.00	26.42	O
ATOM	2388	N	VAL	A	318	85.482	57.545	26.646	1.00	25.51	N
ATOM	2389	CA	VAL	A	318	86.369	57.879	27.760	1.00	24.79	C
ATOM	2390	C	VAL	A	318	87.219	59.133	27.554	1.00	25.38	C
ATOM	2391	O	VAL	A	318	87.633	59.437	26.438	1.00	25.50	O
ATOM	2392	CB	VAL	A	318	87.317	56.693	28.049	1.00	24.92	C
ATOM	2393	CG1	VAL	A	318	88.363	57.081	29.090	1.00	24.67	C
ATOM	2394	CG2	VAL	A	318	86.507	55.500	28.535	1.00	23.44	C
ATOM	2395	N	GLY	A	319	87.477	59.851	28.645	1.00	24.73	N
ATOM	2396	CA	GLY	A	319	88.304	61.043	28.578	1.00	25.39	C
ATOM	2397	C	GLY	A	319	87.980	62.097	29.620	1.00	25.66	C
ATOM	2398	O	GLY	A	319	87.076	61.926	30.437	1.00	25.40	O
ATOM	2399	N	VAL	A	320	88.737	63.188	29.609	1.00	24.72	N
ATOM	2400	CA	VAL	A	320	88.484	64.281	30.535	1.00	25.55	C
ATOM	2401	C	VAL	A	320	88.944	65.581	29.903	1.00	23.92	C
ATOM	2402	O	VAL	A	320	90.033	65.653	29.331	1.00	22.93	O
ATOM	2403	CB	VAL	A	320	89.203	64.087	31.899	1.00	27.29	C
ATOM	2404	CG1	VAL	A	320	90.667	64.017	31.693	1.00	32.20	C
ATOM	2405	CG2	VAL	A	320	88.884	65.241	32.838	1.00	26.56	C
ATOM	2406	N	PRO	A	321	88.100	66.625	29.980	1.00	23.64	N
ATOM	2407	CA	PRO	A	321	88.438	67.928	29.408	1.00	22.67	C
ATOM	2408	C	PRO	A	321	89.872	68.279	29.791	1.00	22.52	C
ATOM	2409	O	PRO	A	321	90.232	68.263	30.961	1.00	23.18	O
ATOM	2410	CB	PRO	A	321	87.381	68.823	30.028	1.00	23.67	C
ATOM	2411	CG	PRO	A	321	86.164	67.896	29.986	1.00	20.93	C
ATOM	2412	CD	PRO	A	321	86.780	66.686	30.640	1.00	22.53	C
ATOM	2413	N	GLN	A	322	90.679	68.588	28.786	1.00	22.16	N
ATOM	2414	CA	GLN	A	322	92.099	68.880	28.948	1.00	21.62	C
ATOM	2415	C	GLN	A	322	92.573	69.884	30.002	1.00	20.84	C
ATOM	2416	O	GLN	A	322	93.551	69.609	30.679	1.00	21.63	O
ATOM	2417	CB	GLN	A	322	92.684	69.245	27.578	1.00	22.97	C
ATOM	2418	CG	GLN	A	322	94.217	69.292	27.491	1.00	24.38	C

TABLE 7-continued

ATOM	2419	CD	GLN	A	322	94.896	67.951	27.725	1.00	23.75	C
ATOM	2420	OE1	GLN	A	322	96.067	67.776	27.390	1.00	26.82	O
ATOM	2421	NE2	GLN	A	322	94.176	67.011	28.314	1.00	23.57	N
ATOM	2422	N	VAL	A	323	91.932	71.037	30.151	1.00	19.60	N
ATOM	2423	CA	VAL	A	323	92.401	71.970	31.175	1.00	19.52	C
ATOM	2424	C	VAL	A	323	92.280	71.357	32.572	1.00	20.46	C
ATOM	2425	O	VAL	A	323	93.144	71.556	33.420	1.00	22.03	O
ATOM	2426	CB	VAL	A	323	91.645	73.322	31.143	1.00	17.80	C
ATOM	2427	CG1	VAL	A	323	92.026	74.177	32.359	1.00	17.57	C
ATOM	2428	CG2	VAL	A	323	92.009	74.070	29.888	1.00	18.00	C
ATOM	2429	N	THR	A	324	91.210	70.616	32.815	1.00	21.51	N
ATOM	2430	CA	THR	A	324	91.029	69.961	34.106	1.00	21.74	C
ATOM	2431	C	THR	A	324	92.056	68.845	34.307	1.00	22.09	C
ATOM	2432	O	THR	A	324	92.628	68.704	35.393	1.00	22.04	O
ATOM	2433	CB	THR	A	324	89.616	69.383	34.221	1.00	21.42	C
ATOM	2434	OG1	THR	A	324	88.696	70.448	34.469	1.00	23.37	O
ATOM	2435	CG2	THR	A	324	89.532	68.370	35.335	1.00	24.31	C
ATOM	2436	N	ALA	A	325	92.296	68.062	33.256	1.00	21.63	N
ATOM	2437	CA	ALA	A	325	93.253	66.958	33.324	1.00	23.09	C
ATOM	2438	C	ALA	A	325	94.669	67.437	33.668	1.00	23.65	C
ATOM	2439	O	ALA	A	325	95.325	66.865	34.540	1.00	23.99	O
ATOM	2440	CB	ALA	A	325	93.262	66.192	32.006	1.00	22.44	C
ATOM	2441	N	ILE	A	326	95.134	68.472	32.967	1.00	23.50	N
ATOM	2442	CA	ILE	A	326	96.458	69.067	33.182	1.00	23.40	C
ATOM	2443	C	ILE	A	326	96.576	69.483	34.641	1.00	24.71	C
ATOM	2444	O	ILE	A	326	97.520	69.124	35.337	1.00	24.66	O
ATOM	2445	CB	ILE	A	326	96.644	70.329	32.295	1.00	22.70	C
ATOM	2446	CG1	ILE	A	326	96.680	69.913	30.821	1.00	22.18	C
ATOM	2447	CG2	ILE	A	326	97.900	71.096	32.699	1.00	20.32	C
ATOM	2448	CD1	ILE	A	326	96.689	71.078	29.861	1.00	22.52	C
ATOM	2449	N	TYR	A	327	95.589	70.244	35.082	1.00	25.51	N
ATOM	2450	CA	TYR	A	327	95.512	70.739	36.439	1.00	27.53	C
ATOM	2451	C	TYR	A	327	95.493	69.644	37.506	1.00	26.67	C
ATOM	2452	O	TYR	A	327	96.234	69.706	38.470	1.00	26.34	O
ATOM	2453	CB	TYR	A	327	94.278	71.615	36.527	1.00	31.94	C
ATOM	2454	CG	TYR	A	327	93.867	72.043	37.900	1.00	36.64	C
ATOM	2455	CD1	TYR	A	327	93.354	71.127	38.812	1.00	40.23	C
ATOM	2456	CD2	TYR	A	327	93.868	73.375	38.243	1.00	38.78	C
ATOM	2457	CE1	TYR	A	327	92.839	71.536	40.027	1.00	42.47	C
ATOM	2458	CE2	TYR	A	327	93.358	73.790	39.431	1.00	42.01	C
ATOM	2459	CZ	TYR	A	327	92.838	72.873	40.329	1.00	43.22	C
ATOM	2460	OH	TYR	A	327	92.305	73.316	41.524	1.00	47.71	O
ATOM	2461	N	ASP	A	328	94.635	68.650	37.347	1.00	27.41	N
ATOM	2462	CA	ASP	A	328	94.573	67.559	38.312	1.00	28.23	C
ATOM	2463	C	ASP	A	328	95.910	66.825	38.383	1.00	28.97	C
ATOM	2464	O	ASP	A	328	96.342	66.414	39.455	1.00	30.49	O
ATOM	2465	CB	ASP	A	328	93.469	66.570	37.925	1.00	28.63	C
ATOM	2466	CG	ASP	A	328	92.074	67.171	38.042	1.00	29.55	C
ATOM	2467	OD1	ASP	A	328	91.096	66.496	37.643	1.00	28.91	O
ATOM	2468	OD2	ASP	A	328	91.954	68.312	38.541	1.00	30.66	O
ATOM	2469	N	ALA	A	329	96.568	66.666	37.237	1.00	28.70	N
ATOM	2470	CA	ALA	A	329	97.848	65.969	37.185	1.00	27.96	C
ATOM	2471	C	ALA	A	329	98.993	66.816	37.713	1.00	27.90	C
ATOM	2472	O	ALA	A	329	99.898	66.303	38.368	1.00	27.58	O
ATOM	2473	CB	ALA	A	329	98.150	65.534	35.755	1.00	28.88	C
ATOM	2474	N	ALA	A	330	98.950	68.112	37.417	1.00	27.54	N
ATOM	2475	CA	ALA	A	330	99.993	69.041	37.839	1.00	27.36	C
ATOM	2476	C	ALA	A	330	100.035	69.195	39.352	1.00	27.62	C
ATOM	2477	O	ALA	A	330	101.039	69.631	39.909	1.00	27.21	O
ATOM	2478	CB	ALA	A	330	99.784	70.397	37.175	1.00	26.61	C
ATOM	2479	N	ALA	A	331	98.941	68.841	40.016	1.00	28.38	N
ATOM	2480	CA	ALA	A	331	98.882	68.923	41.467	1.00	29.60	C
ATOM	2481	C	ALA	A	331	99.870	67.902	42.005	1.00	30.94	C
ATOM	2482	O	ALA	A	331	100.556	68.144	42.995	1.00	31.96	O
ATOM	2483	CB	ALA	A	331	97.489	68.601	41.955	1.00	29.46	C
ATOM	2484	N	VAL	A	332	99.941	66.756	41.334	1.00	31.86	N
ATOM	2485	CA	VAL	A	332	100.851	65.683	41.723	1.00	31.71	C
ATOM	2486	C	VAL	A	332	102.276	65.984	41.267	1.00	32.27	C
ATOM	2487	O	VAL	A	332	103.231	65.700	41.981	1.00	32.86	O
ATOM	2488	CB	VAL	A	332	100.408	64.328	41.122	1.00	30.47	C
ATOM	2489	CG1	VAL	A	332	101.394	63.229	41.512	1.00	29.17	C
ATOM	2490	CG2	VAL	A	332	99.009	63.989	41.602	1.00	29.70	C
ATOM	2491	N	ALA	A	333	102.412	66.561	40.078	1.00	32.53	N
ATOM	2492	CA	ALA	A	333	103.723	66.889	39.543	1.00	33.43	C
ATOM	2493	C	ALA	A	333	104.469	67.763	40.528	1.00	35.24	C
ATOM	2494	O	ALA	A	333	105.677	67.623	40.701	1.00	35.30	O
ATOM	2495	CB	ALA	A	333	103.587	67.607	38.218	1.00	32.68	C
ATOM	2496	N	ARG	A	334	103.757	68.675	41.178	1.00	36.59	N
ATOM	2497	CA	ARG	A	334	104.422	69.544	42.136	1.00	38.67	C

TABLE 7-continued

ATOM	2498	C	ARG	A	334	104.682	68.857	43.458	1.00	38.64	C
ATOM	2499	O	ARG	A	334	105.646	69.181	44.140	1.00	39.25	O
ATOM	2500	CB	ARG	A	334	103.650	70.853	42.343	1.00	39.27	C
ATOM	2501	CG	ARG	A	334	102.152	70.742	42.460	1.00	41.57	C
ATOM	2502	CD	ARG	A	334	101.611	72.112	42.821	1.00	42.79	C
ATOM	2503	NE	ARG	A	334	102.174	73.143	41.953	1.00	41.68	N
ATOM	2504	CZ	ARG	A	334	102.177	74.441	42.245	1.00	41.25	C
ATOM	2505	NH1	ARG	A	334	101.648	74.876	43.384	1.00	39.55	N
ATOM	2506	NH2	ARG	A	334	102.728	75.304	41.405	1.00	40.34	N
ATOM	2507	N	GLU	A	335	103.833	67.902	43.814	1.00	38.96	N
ATOM	2508	CA	GLU	A	335	104.029	67.158	45.046	1.00	39.04	C
ATOM	2509	C	GLU	A	335	105.352	66.414	44.911	1.00	37.56	C
ATOM	2510	O	GLU	A	335	106.158	66.383	45.836	1.00	39.04	O
ATOM	2511	CB	GLU	A	335	102.895	66.157	45.258	1.00	40.81	C
ATOM	2512	CG	GLU	A	335	103.154	65.182	46.393	1.00	45.59	C
ATOM	2513	CD	GLU	A	335	102.064	64.136	46.538	1.00	48.65	C
ATOM	2514	OE1	GLU	A	335	102.219	63.227	47.383	1.00	49.61	O
ATOM	2515	OE2	GLU	A	335	101.048	64.224	45.812	1.00	51.22	O
ATOM	2516	N	TYR	A	336	105.571	65.828	43.741	1.00	35.56	N
ATOM	2517	CA	TYR	A	336	106.786	65.075	43.458	1.00	33.65	C
ATOM	2518	C	TYR	A	336	107.915	65.956	42.950	1.00	32.06	C
ATOM	2519	O	TYR	A	336	109.037	65.493	42.753	1.00	31.27	O
ATOM	2520	CB	TYR	A	336	106.508	63.979	42.418	1.00	34.56	C
ATOM	2521	CG	TYR	A	336	105.700	62.806	42.928	1.00	35.16	C
ATOM	2522	CD1	TYR	A	336	106.183	61.504	42.802	1.00	35.01	C
ATOM	2523	CD2	TYR	A	336	104.465	62.992	43.544	1.00	35.65	C
ATOM	2524	CE1	TYR	A	336	105.460	60.418	43.278	1.00	35.67	C
ATOM	2525	CE2	TYR	A	336	103.730	61.910	44.025	1.00	36.28	C
ATOM	2526	CZ	TYR	A	336	104.234	60.624	43.890	1.00	35.77	C
ATOM	2527	OH	TYR	A	336	103.516	59.548	44.372	1.00	36.21	O
ATOM	2528	N	GLY	A	337	107.619	67.230	42.738	1.00	31.22	N
ATOM	2529	CA	GLY	A	337	108.635	68.122	42.229	1.00	29.58	C
ATOM	2530	C	GLY	A	337	109.068	67.679	40.847	1.00	29.59	C
ATOM	2531	O	GLY	A	337	110.232	67.802	40.488	1.00	30.15	O
ATOM	2532	N	LYS	A	338	108.128	67.142	40.073	1.00	29.98	N
ATOM	2533	CA	LYS	A	338	108.413	66.698	38.713	1.00	29.30	C
ATOM	2534	C	LYS	A	338	107.596	67.477	37.683	1.00	28.77	C
ATOM	2535	O	LYS	A	338	106.830	68.377	38.040	1.00	27.37	O
ATOM	2536	CB	LYS	A	338	108.180	65.191	38.585	1.00	30.27	C
ATOM	2537	CG	LYS	A	338	109.235	64.382	39.330	1.00	32.74	C
ATOM	2538	CD	LYS	A	338	109.034	62.886	39.194	1.00	36.45	C
ATOM	2539	CE	LYS	A	338	110.170	62.116	39.867	1.00	38.61	C
ATOM	2540	NZ	LYS	A	338	110.001	60.628	39.761	1.00	40.61	N
ATOM	2541	N	THR	A	339	107.749	67.131	36.407	1.00	27.82	N
ATOM	2542	CA	THR	A	339	107.056	67.863	35.356	1.00	26.32	C
ATOM	2543	C	THR	A	339	105.980	67.165	34.517	1.00	26.06	C
ATOM	2544	O	THR	A	339	105.806	65.943	34.542	1.00	25.01	O
ATOM	2545	CB	THR	A	339	108.072	68.484	34.409	1.00	26.34	C
ATOM	2546	OG1	THR	A	339	108.901	67.454	33.864	1.00	25.90	O
ATOM	2547	CG2	THR	A	339	108.934	69.484	35.155	1.00	26.42	C
ATOM	2548	N	ILE	A	340	105.267	67.988	33.757	1.00	25.60	N
ATOM	2549	CA	ILE	A	340	104.174	67.543	32.911	1.00	24.59	C
ATOM	2550	C	ILE	A	340	104.152	68.189	31.525	1.00	23.54	C
ATOM	2551	O	ILE	A	340	104.555	69.337	31.342	1.00	21.85	O
ATOM	2552	CB	ILE	A	340	102.842	67.794	33.644	1.00	25.00	C
ATOM	2553	CG1	ILE	A	340	102.598	66.631	34.599	1.00	26.20	C
ATOM	2554	CG2	ILE	A	340	101.707	68.034	32.668	1.00	25.49	C
ATOM	2555	CD1	ILE	A	340	101.382	66.774	35.436	1.00	29.56	C
ATOM	2556	N	ILE	A	341	103.695	67.414	30.548	1.00	22.21	N
ATOM	2557	CA	ILE	A	341	103.573	67.873	29.176	1.00	20.48	C
ATOM	2558	C	ILE	A	341	102.080	67.824	28.863	1.00	19.91	C
ATOM	2559	O	ILE	A	341	101.439	66.793	29.068	1.00	18.38	O
ATOM	2560	CB	ILE	A	341	104.346	66.941	28.210	1.00	21.69	C
ATOM	2561	CG1	ILE	A	341	105.849	67.038	28.496	1.00	23.08	C
ATOM	2562	CG2	ILE	A	341	104.043	67.290	26.755	1.00	19.22	C
ATOM	2563	CD1	ILE	A	341	106.695	66.098	27.657	1.00	23.45	C
ATOM	2564	N	ALA	A	342	101.530	68.958	28.427	1.00	19.15	N
ATOM	2565	CA	ALA	A	342	100.121	69.060	28.046	1.00	19.91	C
ATOM	2566	C	ALA	A	342	100.064	68.553	26.601	1.00	20.89	C
ATOM	2567	O	ALA	A	342	100.556	69.205	25.680	1.00	20.43	O
ATOM	2568	CB	ALA	A	342	99.663	70.504	28.125	1.00	19.17	C
ATOM	2569	N	ASP	A	343	99.451	67.388	26.418	1.00	21.90	N
ATOM	2570	CA	ASP	A	343	99.390	66.729	25.121	1.00	22.21	C
ATOM	2571	C	ASP	A	343	98.038	66.728	24.406	1.00	23.22	C
ATOM	2572	O	ASP	A	343	97.128	66.005	24.796	1.00	23.89	O
ATOM	2573	CB	ASP	A	343	99.863	65.283	25.318	1.00	23.79	C
ATOM	2574	CG	ASP	A	343	99.944	64.499	24.028	1.00	26.58	C
ATOM	2575	OD1	ASP	A	343	100.061	63.251	24.106	1.00	25.81	O
ATOM	2576	OD2	ASP	A	343	99.911	65.122	22.941	1.00	27.87	O

TABLE 7-continued

ATOM	2577	N	GLY	A	344	97.917	67.541	23.359	1.00	24.09	N
ATOM	2578	CA	GLY	A	344	96.696	67.569	22.565	1.00	24.48	C
ATOM	2579	C	GLY	A	344	95.592	68.587	22.818	1.00	24.98	C
ATOM	2580	O	GLY	A	344	95.510	69.210	23.888	1.00	25.91	O
ATOM	2581	N	GLY	A	345	94.737	68.753	21.809	1.00	23.62	N
ATOM	2582	CA	GLY	A	345	93.614	69.664	21.922	1.00	22.65	C
ATOM	2583	C	GLY	A	345	93.944	71.128	21.758	1.00	22.90	C
ATOM	2584	O	GLY	A	345	93.060	71.969	21.869	1.00	23.02	O
ATOM	2585	N	ILE	A	346	95.207	71.443	21.498	1.00	22.89	N
ATOM	2586	CA	ILE	A	346	95.637	72.827	21.322	1.00	23.44	C
ATOM	2587	C	ILE	A	346	95.528	73.267	19.869	1.00	25.23	C
ATOM	2588	O	ILE	A	346	96.157	72.681	18.992	1.00	26.62	O
ATOM	2589	CB	ILE	A	346	97.090	73.005	21.774	1.00	22.40	C
ATOM	2590	CG1	ILE	A	346	97.160	72.887	23.297	1.00	23.15	C
ATOM	2591	CG2	ILE	A	346	97.631	74.327	21.268	1.00	22.29	C
ATOM	2592	CD1	ILE	A	346	98.558	72.897	23.857	1.00	25.18	C
ATOM	2593	N	LYS	A	347	94.744	74.305	19.603	1.00	25.74	N
ATOM	2594	CA	LYS	A	347	94.605	74.756	18.228	1.00	26.93	C
ATOM	2595	C	LYS	A	347	95.037	76.200	18.004	1.00	26.46	C
ATOM	2596	O	LYS	A	347	95.310	76.602	16.874	1.00	27.31	O
ATOM	2597	CB	LYS	A	347	93.169	74.501	17.744	1.00	29.47	C
ATOM	2598	CG	LYS	A	347	92.093	75.047	18.644	1.00	32.60	C
ATOM	2599	CD	LYS	A	347	90.778	74.293	18.454	1.00	36.26	C
ATOM	2600	CE	LYS	A	347	89.680	74.859	19.374	1.00	39.81	C
ATOM	2601	NZ	LYS	A	347	90.034	74.868	20.845	1.00	39.97	N
ATOM	2602	N	TYR	A	348	95.136	76.968	19.081	1.00	24.97	N
ATOM	2603	CA	TYR	A	348	95.552	78.357	18.982	1.00	24.76	C
ATOM	2604	C	TYR	A	348	96.692	78.637	19.951	1.00	25.00	C
ATOM	2605	O	TYR	A	348	96.810	77.976	20.987	1.00	24.58	O
ATOM	2606	CB	TYR	A	348	94.384	79.280	19.313	1.00	25.92	C
ATOM	2607	CG	TYR	A	348	93.224	79.180	18.362	1.00	29.00	C
ATOM	2608	CD1	TYR	A	348	93.363	79.544	17.014	1.00	31.01	C
ATOM	2609	CD2	TYR	A	348	91.975	78.759	18.806	1.00	30.18	C
ATOM	2610	CE1	TYR	A	348	92.280	79.496	16.139	1.00	31.84	C
ATOM	2611	CE2	TYR	A	348	90.886	78.706	17.940	1.00	32.70	C
ATOM	2612	CZ	TYR	A	348	91.046	79.078	16.614	1.00	33.71	C
ATOM	2613	OH	TYR	A	348	89.960	79.054	15.775	1.00	37.15	O
ATOM	2614	N	SER	A	349	97.523	79.626	19.629	1.00	23.37	N
ATOM	2615	CA	SER	A	349	98.632	79.970	20.503	1.00	23.44	C
ATOM	2616	C	SER	A	349	98.093	80.308	21.894	1.00	23.36	C
ATOM	2617	O	SER	A	349	98.747	80.049	22.900	1.00	23.98	O
ATOM	2618	CB	SER	A	349	99.432	81.151	19.936	1.00	23.65	C
ATOM	2619	OG	SER	A	349	98.657	82.331	19.874	1.00	24.07	O
ATOM	2620	N	GLY	A	350	96.896	80.880	21.950	1.00	22.72	N
ATOM	2621	CA	GLY	A	350	96.310	81.212	23.234	1.00	22.54	C
ATOM	2622	C	GLY	A	350	96.093	79.964	24.071	1.00	23.59	C
ATOM	2623	O	GLY	A	350	96.186	80.009	25.291	1.00	23.00	O
ATOM	2624	N	ASP	A	351	95.798	78.847	23.407	1.00	23.75	N
ATOM	2625	CA	ASP	A	351	95.573	77.573	24.085	1.00	23.84	C
ATOM	2626	C	ASP	A	351	96.850	77.093	24.770	1.00	23.49	C
ATOM	2627	O	ASP	A	351	96.798	76.434	25.811	1.00	22.59	O
ATOM	2628	CB	ASP	A	351	95.097	76.509	23.088	1.00	25.03	C
ATOM	2629	CG	ASP	A	351	93.660	76.720	22.638	1.00	27.18	C
ATOM	2630	OD1	ASP	A	351	93.215	76.016	21.707	1.00	28.04	O
ATOM	2631	OD2	ASP	A	351	92.966	77.576	23.226	1.00	30.15	O
ATOM	2632	N	ILE	A	352	97.994	77.421	24.178	1.00	22.40	N
ATOM	2633	CA	ILE	A	352	99.274	77.032	24.749	1.00	20.34	C
ATOM	2634	C	ILE	A	352	99.452	77.716	26.102	1.00	21.36	C
ATOM	2635	O	ILE	A	352	99.879	77.084	27.069	1.00	22.39	O
ATOM	2636	CB	ILE	A	352	100.445	77.431	23.830	1.00	18.46	C
ATOM	2637	CG1	ILE	A	352	100.296	76.753	22.474	1.00	17.19	C
ATOM	2638	CG2	ILE	A	352	101.756	77.042	24.462	1.00	17.65	C
ATOM	2639	CD1	ILE	A	352	101.395	77.086	21.512	1.00	17.04	C
ATOM	2640	N	VAL	A	353	99.122	79.005	26.172	1.00	20.35	N
ATOM	2641	CA	VAL	A	353	99.269	79.753	27.413	1.00	20.32	C
ATOM	2642	C	VAL	A	353	98.328	79.228	28.496	1.00	19.94	C
ATOM	2643	O	VAL	A	353	98.671	79.204	29.671	1.00	20.43	O
ATOM	2644	CB	VAL	A	353	98.997	81.250	27.189	1.00	21.35	C
ATOM	2645	CG1	VAL	A	353	99.315	82.026	28.455	1.00	21.91	C
ATOM	2646	CG2	VAL	A	353	99.826	81.765	26.024	1.00	22.51	C
ATOM	2647	N	LYS	A	354	97.131	78.809	28.098	1.00	21.28	N
ATOM	2648	CA	LYS	A	354	96.168	78.266	29.049	1.00	20.46	C
ATOM	2649	C	LYS	A	354	96.674	76.925	29.563	1.00	20.59	C
ATOM	2650	O	LYS	A	354	96.587	76.640	30.758	1.00	21.00	O
ATOM	2651	CB	LYS	A	354	94.797	78.067	28.388	1.00	21.23	C
ATOM	2652	CG	LYS	A	354	94.090	79.344	27.951	1.00	20.48	C
ATOM	2653	CD	LYS	A	354	92.766	79.032	27.264	1.00	19.71	C
ATOM	2654	CE	LYS	A	354	92.118	80.297	26.720	1.00	22.52	C
ATOM	2655	NZ	LYS	A	354	90.917	80.013	25.879	1.00	21.12	N

TABLE 7-continued

ATOM	2656	N	ALA	A	355	97.191	76.099	28.656	1.00	19.85	N
ATOM	2657	CA	ALA	A	355	97.716	74.782	29.017	1.00	20.80	C
ATOM	2658	C	ALA	A	355	98.886	74.933	29.978	1.00	21.77	C
ATOM	2659	O	ALA	A	355	99.037	74.146	30.908	1.00	22.61	O
ATOM	2660	CB	ALA	A	355	98.163	74.022	27.773	1.00	19.41	C
ATOM	2661	N	LEU	A	356	99.722	75.940	29.753	1.00	21.62	N
ATOM	2662	CA	LEU	A	356	100.858	76.168	30.630	1.00	22.27	C
ATOM	2663	C	LEU	A	356	100.367	76.727	31.957	1.00	23.40	C
ATOM	2664	O	LEU	A	356	100.846	76.342	33.015	1.00	24.73	O
ATOM	2665	CB	LEU	A	356	101.843	77.145	29.986	1.00	21.42	C
ATOM	2666	CG	LEU	A	356	102.518	76.717	28.684	1.00	20.49	C
ATOM	2667	CD1	LEU	A	356	103.328	77.875	28.141	1.00	21.00	C
ATOM	2668	CD2	LEU	A	356	103.386	75.488	28.925	1.00	21.89	C
ATOM	2669	N	ALA	A	357	99.396	77.629	31.900	1.00	23.83	N
ATOM	2670	CA	ALA	A	357	98.858	78.243	33.109	1.00	24.49	C
ATOM	2671	C	ALA	A	357	98.115	77.252	34.002	1.00	24.83	C
ATOM	2672	O	ALA	A	357	98.034	77.445	35.210	1.00	24.39	O
ATOM	2673	CB	ALA	A	357	97.943	79.396	32.739	1.00	25.49	C
ATOM	2674	N	ALA	A	358	97.577	76.191	33.412	1.00	23.94	N
ATOM	2675	CA	ALA	A	358	96.856	75.192	34.189	1.00	23.85	C
ATOM	2676	C	ALA	A	358	97.818	74.209	34.853	1.00	24.49	C
ATOM	2677	O	ALA	A	358	97.391	73.320	35.595	1.00	24.74	O
ATOM	2678	CB	ALA	A	358	95.865	74.440	33.300	1.00	24.65	C
ATOM	2679	N	GLY	A	359	99.113	74.349	34.579	1.00	24.04	N
ATOM	2680	CA	GLY	A	359	100.074	73.460	35.206	1.00	23.58	C
ATOM	2681	C	GLY	A	359	101.065	72.763	34.300	1.00	23.49	C
ATOM	2682	O	GLY	A	359	101.964	72.073	34.786	1.00	24.97	O
ATOM	2683	N	GLY	A	360	100.924	72.929	32.990	1.00	22.19	N
ATOM	2684	CA	GLY	A	360	101.847	72.279	32.083	1.00	19.65	C
ATOM	2685	C	GLY	A	360	103.209	72.936	32.105	1.00	20.75	C
ATOM	2686	O	GLY	A	360	103.312	74.134	32.324	1.00	20.45	O
ATOM	2687	N	ASN	A	361	104.258	72.148	31.887	1.00	20.92	N
ATOM	2688	CA	ASN	A	361	105.630	72.655	31.855	1.00	22.23	C
ATOM	2689	C	ASN	A	361	106.051	72.782	30.402	1.00	22.46	C
ATOM	2690	O	ASN	A	361	107.060	73.407	30.079	1.00	22.58	O
ATOM	2691	CB	ASN	A	361	106.568	71.697	32.589	1.00	22.17	C
ATOM	2692	CG	ASN	A	361	106.338	71.703	34.085	1.00	25.53	C
ATOM	2693	OD1	ASN	A	361	106.646	72.688	34.763	1.00	27.16	O
ATOM	2694	ND2	ASN	A	361	105.766	70.624	34.607	1.00	25.19	N
ATOM	2695	N	ALA	A	362	105.251	72.178	29.530	1.00	22.54	N
ATOM	2696	CA	ALA	A	362	105.481	72.193	28.095	1.00	21.37	C
ATOM	2697	C	ALA	A	362	104.229	71.625	27.432	1.00	21.05	C
ATOM	2698	O	ALA	A	362	103.423	70.969	28.084	1.00	18.71	O
ATOM	2699	CB	ALA	A	362	106.704	71.341	27.753	1.00	20.68	C
ATOM	2700	N	VAL	A	363	104.058	71.895	26.142	1.00	22.66	N
ATOM	2701	CA	VAL	A	363	102.903	71.377	25.410	1.00	22.68	C
ATOM	2702	C	VAL	A	363	103.389	70.579	24.210	1.00	22.35	C
ATOM	2703	O	VAL	A	363	104.423	70.893	23.638	1.00	23.37	O
ATOM	2704	CE	VAL	A	363	101.964	72.521	24.910	1.00	22.34	C
ATOM	2705	CG1	VAL	A	363	101.440	73.333	26.088	1.00	21.37	C
ATOM	2706	CG2	VAL	A	363	102.702	73.418	23.929	1.00	22.84	C
HETATM	2707	N	MSE	A	364	102.662	69.530	23.851	1.00	21.88	N
HETATM	2708	CA	MSE	A	364	103.027	68.726	22.692	1.00	22.51	C
HETATM	2709	C	MSE	A	364	102.014	69.063	21.608	1.00	23.49	C
HETATM	2710	O	MSE	A	364	100.794	69.022	21.832	1.00	23.44	O
HETATM	2711	CB	MSE	A	364	103.011	67.231	23.028	1.00	24.05	C
HETATM	2712	CG	MSE	A	364	103.223	66.330	21.821	1.00	27.31	C
HETATM	2713	SE	MSE	A	364	103.374	64.556	22.241	1.00	35.51	SE
HETATM	2714	CE	MSE	A	364	105.096	64.508	22.891	1.00	32.69	C
ATOM	2715	N	LEU	A	365	102.531	69.420	20.436	1.00	23.87	N
ATOM	2716	CA	LEU	A	365	101.704	69.831	19.315	1.00	24.27	C
ATOM	2717	C	LEU	A	365	101.822	68.920	18.108	1.00	25.78	C
ATOM	2718	O	LEU	A	365	102.926	68.614	17.666	1.00	26.09	C
ATOM	2719	CB	LEU	A	365	102.104	71.238	18.905	1.00	22.73	C
ATOM	2720	CG	LEU	A	365	102.093	72.219	20.060	1.00	23.17	C
ATOM	2721	CD1	LEU	A	365	102.705	73.527	19.616	1.00	24.46	C
ATOM	2722	CD2	LEU	A	365	100.670	72.378	20.574	1.00	22.59	C
ATOM	2723	N	GLY	A	366	100.678	68.508	17.569	1.00	26.69	N
ATOM	2724	CA	GLY	A	366	100.667	67.651	16.398	1.00	28.30	C
ATOM	2725	C	GLY	A	366	100.045	68.365	15.213	1.00	29.57	C
ATOM	2726	O	GLY	A	366	100.717	68.663	14.226	1.00	29.34	O
ATOM	2727	N	SER	A	367	98.753	68.644	15.327	1.00	30.92	N
ATOM	2728	CA	SER	A	367	97.993	69.341	14.298	1.00	33.00	C
ATOM	2729	C	SER	A	367	98.648	70.637	13.803	1.00	34.00	C
ATOM	2730	O	SER	A	367	98.750	70.848	12.598	1.00	33.51	O
ATOM	2731	CB	SER	A	367	96.590	69.646	14.832	1.00	34.28	C
ATOM	2732	OG	SER	A	367	95.800	70.345	13.885	1.00	34.75	O
HETATM	2733	N	MSE	A	368	99.097	71.501	14.713	1.00	34.95	N
HETATM	2734	CA	MSE	A	368	99.712	72.765	14.296	1.00	37.45	C

TABLE 7-continued

HETATM	2735	C	MSE	A	368	100.963	72.668	13.424	1.00	36.66	C
HETATM	2736	O	MSE	A	368	101.316	73.635	12.748	1.00	36.99	O
HETATM	2737	CB	MSE	A	368	100.000	73.664	15.506	1.00	40.56	C
HETATM	2738	CG	MSE	A	368	98.719	74.111	16.191	1.00	46.02	C
HETATM	2739	SE	MSE	A	368	98.916	75.343	17.492	1.00	56.80	SE
HETATM	2740	CE	MSE	A	368	99.964	74.527	18.572	1.00	55.31	C
ATOM	2741	N	PHE	A	369	101.626	71.513	13.417	1.00	34.82	N
ATOM	2742	CA	PHE	A	369	102.830	71.339	12.603	1.00	31.76	C
ATOM	2743	C	PHE	A	369	102.600	70.421	11.416	1.00	31.43	C
ATOM	2744	O	PHE	A	369	103.378	70.425	10.467	1.00	30.91	O
ATOM	2745	CB	PHE	A	369	103.977	70.786	13.460	1.00	29.79	C
ATOM	2746	CG	PHE	A	369	104.507	71.765	14.473	1.00	26.59	C
ATOM	2747	CD1	PHE	A	369	104.387	71.518	15.829	1.00	27.53	C
ATOM	2748	CD2	PHE	A	369	105.121	72.947	14.062	1.00	27.73	C
ATOM	2749	CE1	PHE	A	369	104.872	72.444	16.771	1.00	27.77	C
ATOM	2750	CE2	PHE	A	369	105.605	73.874	14.990	1.00	27.15	C
ATOM	2751	CZ	PHE	A	369	105.481	73.622	16.345	1.00	26.83	C
ATOM	2752	N	ALA	A	370	101.510	69.658	11.479	1.00	32.61	N
ATOM	2753	CA	ALA	A	370	101.108	68.668	10.465	1.00	33.73	C
ATOM	2754	C	ALA	A	370	101.243	68.936	8.953	1.00	34.56	C
ATOM	2755	O	ALA	A	370	101.405	67.982	8.173	1.00	35.53	O
ATOM	2756	CB	ALA	A	370	99.682	68.213	10.761	1.00	33.78	C
ATOM	2757	N	GLY	A	371	101.165	70.191	8.518	1.00	33.99	N
ATOM	2758	CA	GLY	A	371	101.282	70.453	7.090	1.00	33.01	C
ATOM	2759	C	GLY	A	371	102.500	71.252	6.666	1.00	33.01	C
ATOM	2760	O	GLY	A	371	102.537	71.811	5.564	1.00	32.73	O
ATOM	2761	N	THR	A	372	103.508	71.299	7.530	1.00	32.22	N
ATOM	2762	CA	THR	A	372	104.724	72.055	7.244	1.00	32.27	C
ATOM	2763	C	THR	A	372	105.688	71.363	6.276	1.00	33.94	C
ATOM	2764	O	THR	A	372	105.448	70.244	5.828	1.00	35.02	O
ATOM	2765	CB	THR	A	372	105.479	72.426	8.567	1.00	30.26	C
ATOM	2766	OG1	THR	A	372	105.828	71.242	9.298	1.00	27.73	O
ATOM	2767	CG2	THR	A	372	104.601	73.299	9.440	1.00	28.61	C
ATOM	2768	N	ASP	A	373	106.771	72.052	5.937	1.00	35.72	N
ATOM	2769	CA	ASP	A	373	107.775	71.506	5.040	1.00	37.55	C
ATOM	2770	C	ASP	A	373	108.346	70.234	5.665	1.00	39.10	C
ATOM	2771	O	ASP	A	373	108.423	69.187	5.023	1.00	39.87	O
ATOM	2772	CB	ASP	A	373	108.893	72.531	4.844	1.00	39.43	C
ATOM	2773	CG	ASP	A	373	108.394	73.826	4.223	1.00	42.12	C
ATOM	2774	OD1	ASP	A	373	109.121	74.847	4.253	1.00	42.31	O
ATOM	2775	CD2	ASP	A	373	107.267	73.815	3.687	1.00	45.19	O
ATOM	2776	N	GLU	A	374	108.720	70.334	6.937	1.00	39.77	N
ATOM	2777	CA	GLU	A	374	109.312	69.224	7.676	1.00	40.52	C
ATOM	2778	C	GLU	A	374	108.430	67.991	7.949	1.00	40.61	C
ATOM	2779	O	GLU	A	374	108.938	66.870	7.961	1.00	41.45	O
ATOM	2780	CB	GLU	A	374	109.859	69.740	9.003	1.00	40.97	C
ATOM	2781	CG	GLU	A	374	110.940	70.800	8.893	1.00	43.47	C
ATOM	2782	CD	GLU	A	374	110.498	72.042	8.138	1.00	46.43	C
ATOM	2783	OE1	GLU	A	374	109.291	72.384	8.186	1.00	46.56	O
ATOM	2784	OE2	GLU	A	374	111.365	72.704	7.520	1.00	48.05	O
ATOM	2785	N	ALA	A	375	107.132	68.180	8.176	1.00	39.40	N
ATOM	2786	CA	ALA	A	375	106.237	67.053	8.467	1.00	39.33	C
ATOM	2787	C	ALA	A	375	106.201	65.981	7.367	1.00	39.58	C
ATOM	2788	O	ALA	A	375	105.988	66.289	6.194	1.00	40.42	O
ATOM	2789	CB	ALA	A	375	104.827	67.568	8.740	1.00	38.20	C
ATOM	2790	N	PRO	A	376	106.397	64.701	7.742	1.00	39.51	N
ATOM	2791	CA	PRO	A	376	106.400	63.547	6.833	1.00	40.37	C
ATOM	2792	C	PRO	A	376	105.074	63.223	6.115	1.00	42.60	C
ATOM	2793	O	PRO	A	376	105.034	62.339	5.257	1.00	44.07	O
ATOM	2794	CB	PRO	A	376	106.840	62.403	7.751	1.00	38.78	C
ATOM	2795	CG	PRO	A	376	107.612	63.112	8.842	1.00	37.80	C
ATOM	2796	CD	PRO	A	376	106.665	64.236	9.111	1.00	37.56	C
ATOM	2797	N	GLY	A	377	103.992	63.916	6.465	1.00	44.20	N
ATOM	2798	CA	GLY	A	377	102.704	63.657	5.829	1.00	45.51	C
ATOM	2799	C	GLY	A	377	102.780	63.611	4.312	1.00	47.08	C
ATOM	2800	O	GLY	A	377	103.714	64.150	3.720	1.00	47.51	O
ATOM	2801	N	GLU	A	378	101.801	62.968	3.681	1.00	48.24	N
ATOM	2802	CA	GLU	A	378	101.759	62.841	2.221	1.00	48.97	C
ATOM	2803	C	GLU	A	378	100.987	64.015	1.627	1.00	48.92	C
ATOM	2804	O	GLU	A	378	99.905	64.345	2.096	1.00	49.36	O
ATOM	2805	CB	GLU	A	378	101.082	61.523	1.828	1.00	50.65	C
ATOM	2806	CG	GLU	A	378	101.750	60.266	2.409	1.00	56.37	C
ATOM	2807	CD	GLU	A	378	101.682	60.184	3.950	1.00	60.26	C
ATOM	2808	OE1	GLU	A	378	100.554	60.078	4.493	1.00	61.73	O
ATOM	2809	OE2	GLU	A	378	102.752	60.225	4.619	1.00	60.95	O
ATOM	2810	N	THR	A	379	101.538	64.648	0.598	1.00	48.86	N
ATOM	2811	CA	THR	A	379	100.868	55.786	-0.030	1.00	49.21	C
ATOM	2812	C	THR	A	379	99.683	65.876	-0.911	1.00	49.89	C
ATOM	2813	O	THR	A	379	99.745	64.394	-1.658	1.00	49.37	O

TABLE 7-continued

ATOM	2814	CB	THR	A	379	101.845	66.617	-0.903	1.00	48.77	C
ATOM	2815	OG1	THR	A	379	102.921	67.089	-0.087	1.00	49.52	O
ATOM	2816	CG2	THR	A	379	101.133	67.821	-1.527	1.00	46.54	C
ATOM	2817	N	GLU	A	380	98.604	66.147	-0.814	1.00	50.46	N
ATOM	2818	CA	GLU	A	380	97.407	65.905	-1.601	1.00	51.12	C
ATOM	2819	C	GLU	A	380	96.897	67.228	-2.134	1.00	50.88	C
ATOM	2820	O	GLU	A	380	97.110	68.283	-1.538	1.00	49.94	O
ATOM	2821	CB	GLU	A	380	96.322	65.227	-0.758	1.00	51.47	C
ATOM	2822	CG	GLU	A	380	96.762	63.909	-0.168	1.00	53.35	C
ATOM	2823	CD	GLU	A	380	95.633	63.169	0.503	1.00	55.74	C
ATOM	2824	OE1	GLU	A	380	94.962	63.764	1.373	1.00	56.99	O
ATOM	2825	OE2	GLU	A	380	95.421	61.983	0.167	1.00	57.47	O
ATOM	2826	N	ILE	A	381	96.226	67.165	-3.272	1.00	52.06	N
ATOM	2827	CA	ILE	A	381	95.697	68.364	-3.884	1.00	53.51	C
ATOM	2828	C	ILE	A	381	94.196	68.250	-4.113	1.00	53.54	C
ATOM	2829	O	ILE	A	381	93.707	67.300	-4.731	1.00	53.35	O
ATOM	2830	CB	ILE	A	381	96.436	68.676	-5.219	1.00	54.46	C
ATOM	2831	CG1	ILE	A	381	96.307	67.515	-6.199	1.00	54.90	C
ATOM	2832	CG2	ILE	A	381	97.919	68.895	-4.947	1.00	55.14	C
ATOM	2833	CD1	ILE	A	381	97.141	67.712	-7.458	1.00	55.73	C
ATOM	2634	N	TYR	A	382	93.472	69.228	-3.579	1.00	53.11	N
ATOM	2835	CA	TYR	A	382	92.029	69.285	-3.699	1.00	52.90	C
ATOM	2836	C	TYR	A	382	91.669	70.747	-3.928	1.00	52.45	C
ATOM	2837	O	TYR	A	382	92.092	71.623	-3.173	1.00	51.87	O
ATOM	2838	CB	TYR	A	382	91.379	68.732	-2.419	1.00	53.99	C
ATOM	2839	CG	TYR	A	382	89.868	68.819	-2.388	1.00	55.14	C
ATOM	2840	CD1	TYR	A	382	89.221	69.793	-1.623	1.00	55.14	C
ATOM	2841	CD2	TYR	A	382	89.084	67.957	-3.161	1.00	55.70	C
ATOM	2842	CE1	TYR	A	382	87.827	69.910	-1.629	1.00	56.22	C
ATOM	2843	CE2	TYR	A	382	87.688	68.066	-3.177	1.00	56.34	C
ATOM	2844	CZ	TYR	A	382	87.066	69.046	-2.410	1.00	56.68	C
ATOM	2845	OH	TYR	A	382	85.693	69.174	-2.439	1.00	57.02	O
ATOM	2846	N	GLN	A	383	90.903	70.999	-4.987	1.00	52.24	N
ATOM	2847	CA	GLN	A	383	90.484	72.348	-5.358	1.00	52.02	C
ATOM	2848	C	GLN	A	383	91.687	73.210	-5.721	1.00	51.03	C
ATOM	2849	O	GLN	A	383	91.619	74.436	-5.661	1.00	50.67	O
ATOM	2850	CB	GLN	A	383	89.707	73.018	-4.218	1.00	53.91	C
ATOM	2851	CG	GLN	A	383	88.436	72.297	-3.794	1.00	56.88	C
ATOM	2852	CD	GLN	A	383	87.451	72.115	-4.934	1.00	59.26	C
ATOM	2853	OE1	GLN	A	383	87.746	71.441	-5.926	1.00	60.79	O
ATOM	2854	NE2	GLN	A	383	86.270	72.718	-4.800	1.00	59.95	N
ATOM	2855	N	GLY	A	384	92.788	72.562	-6.091	1.00	50.37	N
ATOM	2856	CA	GLY	A	384	93.985	73.292	-6.468	1.00	50.11	C
ATOM	2857	C	GLY	A	384	94.977	73.527	-5.341	1.00	49.99	C
ATOM	2858	O	GLY	A	384	96.185	73.637	-5.586	1.00	50.26	O
ATOM	2859	N	ARG	A	385	94.480	73.610	-4.109	1.00	49.41	N
ATOM	2860	CA	ARG	A	385	95.350	73.837	-2.958	1.00	48.78	C
ATOM	2861	C	ARG	A	385	96.049	72.559	-2.527	1.00	47.90	C
ATOM	2862	O	ARG	A	385	95.536	71.456	-2.727	1.00	47.68	O
ATOM	2863	CB	ARG	A	385	94.563	74.379	-1.761	1.00	49.61	C
ATOM	2864	CG	ARG	A	385	93.830	75.696	-1.980	1.00	51.31	C
ATOM	2865	CD	ARG	A	385	92.522	75.518	-2.727	1.00	52.37	C
ATOM	2866	NE	ARG	A	385	91.851	76.801	-2.898	1.00	54.89	N
ATOM	2867	CZ	ARG	A	385	90.660	76.958	-3.467	1.00	56.27	C
ATOM	2868	NH1	ARG	A	385	89.996	75.905	-3.925	1.00	57.58	N
ATOM	2869	NH2	ARG	A	385	90.135	78.170	-3.581	1.00	55.72	N
ATOM	2870	N	LYS	A	386	97.220	72.712	-1.920	1.00	47.18	N
ATOM	2871	CA	LYS	A	386	97.977	71.561	-1.450	1.00	46.53	C
ATOM	2872	C	LYS	A	386	97.702	71.259	0.022	1.00	45.66	C
ATOM	2873	O	LYS	A	386	97.602	72.166	0.857	1.00	45.07	O
ATOM	2874	CB	LYS	A	386	99.478	71.781	-1.642	1.00	46.65	C
ATOM	2875	CG	LYS	A	386	99.942	71.885	-3.082	1.00	48.06	C
ATOM	2876	CD	LYS	A	386	101.451	72.061	-3.101	1.00	50.09	C
ATOM	2877	CE	LYS	A	386	102.017	72.118	-4.505	1.00	51.55	C
ATOM	2878	HZ	LYS	A	386	103.505	72.226	-4.438	1.00	52.03	N
ATOM	2879	N	TYR	A	387	97.580	69.971	0.326	1.00	45.21	N
ATOM	2880	CA	TYR	A	387	97.335	69.515	1.689	1.00	45.09	C
ATOM	2881	C	TYR	A	387	98.420	68.561	2.155	1.00	44.05	C
ATOM	2882	O	TYR	A	387	99.270	68.119	1.380	1.00	44.31	C
ATOM	2883	CB	TYR	A	387	95.978	68.807	1.787	1.00	45.22	C
ATOM	2884	CG	TYR	A	387	94.799	69.725	1.580	1.00	45.09	C
ATOM	2885	CD1	TYR	A	387	94.537	70.291	0.332	1.00	45.10	C
ATOM	2886	CD2	TYR	A	387	93.981	70.063	2.652	1.00	45.00	C
ATOM	2887	CE1	TYR	A	387	93.492	71.194	0.160	1.00	45.13	C
ATOM	2888	CE2	TYR	A	387	92.941	70.979	2.491	1.00	45.41	C
ATOM	2889	CZ	TYR	A	387	92.707	71.531	1.246	1.00	45.60	C
ATOM	2890	OH	TYR	A	387	91.701	72.444	1.104	1.00	47.56	O
ATOM	2891	N	LYS	A	388	98.381	68.248	3.438	1.00	43.76	N
ATOM	2892	CA	LYS	A	388	99.328	67.326	4.034	1.00	43.49	C

TABLE 7-continued

ATOM	2893	C	LYS	A	388	98.501	66.389	4.865	1.00	41.84	C
ATOM	2894	O	LYS	A	388	97.731	66.834	5.703	1.00	40.70	O
ATOM	2895	CB	LYS	A	388	100.317	68.067	4.932	1.00	45.64	C
ATOM	2896	CG	LYS	A	388	101.504	68.715	4.213	1.00	48.31	C
ATOM	2897	CD	LYS	A	388	102.626	67.706	3.892	1.00	47.96	C
ATOM	2898	CE	LYS	A	388	103.901	68.437	3.466	1.00	47.56	C
ATOM	2899	NZ	LYS	A	388	105.097	67.563	3.426	1.00	46.67	N
ATOM	2900	N	THR	A	389	98.647	65.092	4.617	1.00	42.01	N
ATOM	2901	CA	THR	A	389	97.902	64.098	5.370	1.00	41.89	C
ATOM	2902	C	THR	A	389	98.290	64.224	6.833	1.00	42.40	C
ATOM	2903	O	THR	A	389	99.418	64.598	7.172	1.00	42.02	O
ATOM	2904	CB	THR	A	389	98.218	62.669	4.909	1.00	41.09	C
ATOM	2905	CG1	THR	A	389	99.623	62.427	5.042	1.00	41.52	O
ATOM	2906	CG2	THR	A	389	97.607	62.474	2.461	1.00	41.23	C
ATOM	2907	N	TYR	A	390	97.330	63.930	7.693	1.00	42.51	N
ATOM	2908	CA	TYR	A	390	97.533	63.980	9.125	1.00	42.75	C
ATOM	2909	C	TYR	A	390	96.624	62.882	9.670	1.00	43.43	C
ATOM	2910	O	TYR	A	390	95.406	62.969	9.551	1.00	44.28	O
ATOM	2911	CB	TYR	A	390	97.098	65.332	9.679	1.00	41.44	C
ATOM	2912	CG	TYR	A	390	97.362	65.467	11.159	1.00	40.95	C
ATOM	2913	CD1	TYR	A	390	96.609	66.343	11.944	1.00	41.25	C
ATOM	2914	CD2	TYR	A	390	98.373	64.729	11.777	1.00	39.46	C
ATOM	2915	CE1	TYR	A	390	96.852	66.478	13.312	1.00	40.17	C
ATOM	2916	CE2	TYR	A	390	98.623	64.856	13.136	1.00	40.26	C
ATOM	2917	CZ	TYR	A	390	97.857	65.732	13.896	1.00	39.92	C
ATOM	2918	OH	TYR	A	390	98.095	65.857	15.238	1.00	40.43	O
ATOM	2919	N	ARG	A	391	97.206	61.846	10.258	1.00	44.01	N
ATOM	2920	CA	ARG	A	391	96.399	60.750	10.772	1.00	44.87	C
ATOM	2921	C	ARG	A	391	96.778	60.387	12.202	1.00	45.41	C
ATOM	2922	O	ARG	A	391	97.954	60.450	12.580	1.00	45.88	O
ATOM	2923	CB	ARG	A	391	96.589	59.529	9.883	1.00	44.93	C
ATOM	2924	CG	ARG	A	391	97.990	58.967	9.986	1.00	46.56	C
ATOM	2925	CD	ARG	A	391	98.242	57.872	8.981	1.00	47.95	C
ATOM	2926	NE	ARG	A	391	99.535	57.232	9.200	1.00	48.70	N
ATOM	2927	CZ	ARG	A	391	100.072	56.357	8.363	1.00	49.29	C
ATOM	2928	NH1	ARG	A	391	99.425	56.024	7.252	1.00	50.30	N
ATOM	2929	NH2	ARG	A	391	101.245	55.805	8.638	1.00	49.69	N
ATOM	2930	N	GLY	A	392	95.782	60.009	12.999	1.00	45.56	N
ATOM	2931	CA	GLY	A	392	96.062	59.618	14.366	1.00	45.33	C
ATOM	2932	C	GLY	A	392	96.803	58.291	14.343	1.00	45.81	C
ATOM	2933	O	GLY	A	392	96.578	57.467	13.451	1.00	45.18	O
HETATM	2934	N	MSE	A	393	97.696	58.074	15.304	1.00	46.09	N
HETATM	2935	CA	MSE	A	393	98.437	56.818	15.344	1.00	46.91	C
HETATM	2936	C	MSE	A	393	97.514	55.638	15.668	1.00	45.83	C
HETATM	2937	O	MSE	A	393	97.905	54.474	15.553	1.00	45.29	O
HETATM	2938	CB	MSE	A	393	99.587	56.925	16.351	1.00	48.46	C
HETATM	2939	CG	MSE	A	393	100.671	57.905	15.906	1.00	51.44	C
HETATM	2940	SE	MSE	A	393	101.600	57.363	14.403	1.00	55.48	SE
HETATM	2941	CE	MSE	A	393	102.496	55.927	15.071	1.00	55.49	C
ATOM	2942	N	GLY	A	394	96.280	55.954	16.049	1.00	44.70	N
ATOM	2943	CA	GLY	A	394	95.307	54.926	16.364	1.00	44.19	C
ATOM	2944	C	GLY	A	394	94.355	54.686	15.206	1.00	44.14	C
ATOM	2945	O	GLY	A	394	93.416	53.896	15.311	1.00	43.61	O
ATOM	2946	N	SER	A	395	94.591	55.369	14.093	1.00	44.85	N
ATOM	2947	CA	SER	A	395	93.740	55.204	12.921	1.00	45.69	C
ATOM	2948	C	SER	A	395	94.061	53.866	12.265	1.00	46.80	C
ATOM	2949	O	SER	A	395	95.002	53.175	12.663	1.00	47.02	O
ATOM	2950	CB	SER	A	395	93.968	56.340	11.916	1.00	45.01	C
ATOM	2951	OG	SER	A	395	95.278	56.305	11.372	1.00	44.71	O
ATOM	2952	N	ILE	A	396	93.276	53.501	11.261	1.00	47.68	N
ATOM	2953	CA	ILE	A	396	93.488	52.245	10.554	1.00	49.11	C
ATOM	2954	C	ILE	A	396	94.830	52.246	9.797	1.00	49.53	C
ATOM	2955	O	ILE	A	396	95.705	51.418	10.070	1.00	48.83	O
ATOM	2956	CB	ILE	A	396	92.320	51.974	9.558	1.00	49.53	C
ATOM	2957	CG1	ILE	A	396	90.990	51.908	10.315	1.00	49.28	C
ATOM	2958	CG2	ILE	A	396	92.554	50.670	8.812	1.00	49.14	C
ATOM	2959	CD1	ILE	A	396	90.932	50.820	11.363	1.00	49.48	C
ATOM	2960	N	ALA	A	397	94.988	53.183	8.863	1.00	50.24	N
ATOM	2961	CA	ALA	A	397	96.206	53.291	8.062	1.00	51.94	C
ATOM	2962	C	ALA	A	397	97.475	53.255	8.903	1.00	53.51	C
ATOM	2963	O	ALA	A	397	98.414	52.533	8.576	1.00	53.35	O
ATOM	2964	CB	ALA	A	397	96.177	54.567	7.227	1.00	50.87	C
ATOM	2965	N	ALA	A	398	97.507	54.037	9.979	1.00	55.56	N
ATOM	2966	CA	ALA	A	398	98.677	54.074	10.851	1.00	57.66	C
ATOM	2967	C	ALA	A	398	98.878	52.719	11.529	1.00	59.35	C
ATOM	2968	O	ALA	A	398	99.988	52.181	11.541	1.00	59.25	O
ATOM	2969	CB	ALA	A	398	98.525	55.175	11.900	1.00	56.88	C
HETATM	2970	N	MSE	A	399	97.803	52.162	12.084	1.00	61.57	N
HETATM	2971	CA	MSE	A	399	97.883	50.868	12.753	1.00	63.53	C

TABLE 7-continued

HETATM	2972	C	MSE	A	399	98.165	49.736	11.778	1.00	64.22	C
HETATM	2973	O	MSE	A	399	98.294	48.586	12.181	1.00	64.45	O
HETATM	2974	CB	MSE	A	399	96.589	50.561	13.510	1.00	64.53	C
HETATM	2975	CG	MSE	A	399	96.335	51.428	14.726	1.00	66.17	C
HETATM	2976	SE	MSE	A	399	94.927	50.801	15.688	1.00	70.47	SE
HETATM	2977	CE	MSE	A	399	93.579	50.893	14.454	1.00	68.03	C
ATOM	2978	N	LYS	A	400	98.275	50.067	10.498	1.00	65.70	N
ATOM	2979	CA	LYS	A	400	98.535	49.076	9.461	1.00	67.25	C
ATOM	2980	C	LYS	A	400	99.753	48.195	9.743	1.00	68.24	C
ATOM	2981	O	LYS	A	400	100.162	48.015	10.888	1.00	68.63	O
ATOM	2982	CB	LYS	A	400	98.703	49.771	8.118	1.00	67.70	C
ATOM	2983	N	LYS	A	401	100.324	47.646	8.677	1.00	69.15	N
ATOM	2984	CA	LYS	A	401	101.487	46.771	8.773	1.00	70.20	C
ATOM	2985	C	LYS	A	401	102.588	47.357	9.662	1.00	71.05	C
ATOM	2986	O	LYS	A	401	102.394	48.471	10.197	1.00	71.27	O
ATOM	2987	CB	LYS	A	401	102.035	46.483	7.365	1.00	69.48	C
ATOM	2988	N	ASN	A	416	92.074	47.487	5.186	1.00	72.24	N
ATOM	2989	CA	ASN	A	416	91.155	46.876	6.194	1.00	72.64	C
ATOM	2990	C	ASN	A	416	91.165	47.666	7.501	1.00	72.60	C
ATOM	2991	O	ASN	A	416	92.209	48.176	7.915	1.00	73.31	O
ATOM	2992	CB	ASN	A	416	91.563	45.422	6.465	1.00	72.21	C
ATOM	2993	N	LYS	A	417	90.004	47.744	8.152	1.00	71.58	N
ATOM	2994	CA	LYS	A	417	89.858	48.463	9.419	1.00	70.32	C
ATOM	2995	C	LYS	A	417	89.985	47.484	10.580	1.00	69.53	C
ATOM	2996	O	LYS	A	417	89.416	46.386	10.515	1.00	70.17	O
ATOM	2997	CB	LYS	A	417	88.499	49.146	9.472	1.00	70.50	C
ATOM	2998	N	LEU	A	418	90.712	47.870	11.642	1.00	67.91	N
ATOM	2999	CA	LEU	A	418	90.903	46.996	12.826	1.00	64.90	C
ATOM	3000	C	LEU	A	418	90.637	47.647	14.211	1.00	62.37	C
ATOM	3001	O	LEU	A	418	91.478	47.559	15.111	1.00	62.60	O
ATOM	3002	CB	LEU	A	418	92.286	46.414	12.785	1.00	64.79	C
ATOM	3003	N	VAL	A	419	99.455	48.260	14.362	1.00	59.18	N
ATOM	3004	CA	VAL	A	419	88.983	48.973	15.576	1.00	56.04	C
ATOM	3005	C	VAL	A	419	89.820	50.195	15.995	1.00	53.39	C
ATOM	3006	O	VAL	A	419	90.533	50.180	17.005	1.00	51.68	O
ATOM	3007	CB	VAL	A	419	88.825	48.027	16.790	1.00	56.09	C
ATOM	3008	CG1	VAL	A	419	88.330	48.818	18.006	1.00	55.27	C
ATOM	3009	CG2	VAL	A	419	87.823	46.925	16.456	1.00	56.32	C
ATOM	3010	N	PRO	A	420	89.728	51.280	15.207	1.00	51.10	N
ATOM	3011	CA	PRO	A	420	90.430	52.548	15.402	1.00	49.87	C
ATOM	3012	C	PRO	A	420	89.937	53.428	16.559	1.00	48.67	C
ATOM	3013	O	PRO	A	420	88.758	53.419	16.924	1.00	47.55	O
ATOM	3014	CB	PRO	A	420	90.238	53.225	14.052	1.00	49.97	C
ATOM	3015	CG	PRO	A	420	88.824	52.828	13.734	1.00	49.16	C
ATOM	3016	CD	PRO	A	420	88.939	51.338	13.961	1.00	49.81	C
ATOM	3017	N	GLU	A	421	90.871	54.192	17.116	1.00	48.34	N
ATOM	3018	CA	GLU	A	421	90.610	55.123	18.208	1.00	47.97	C
ATOM	3019	C	GLU	A	421	90.154	56.506	17.668	1.00	46.84	C
ATOM	3020	O	GLU	A	421	91.005	57.481	18.409	1.00	47.51	O
ATOM	3021	CB	GLU	A	421	91.517	54.809	19.396	1.00	49.79	C
ATOM	3022	CG	GLU	A	421	91.207	53.512	20.149	1.00	53.19	C
ATOM	3023	CD	GLU	A	421	90.329	53.739	21.372	1.00	53.99	C
ATOM	3024	OE1	GLU	A	421	90.730	54.563	22.228	1.00	55.23	O
ATOM	3025	OE2	GLU	A	421	89.260	53.095	21.484	1.00	53.71	O
ATOM	3026	N	GLY	A	422	91.200	56.576	16.366	1.00	45.35	N
ATOM	3027	CA	GLY	A	422	91.541	57.834	15.736	1.00	44.97	C
ATOM	3028	C	GLY	A	422	91.214	57.813	14.253	1.00	44.86	C
ATOM	3029	O	GLY	A	422	90.918	56.760	13.684	1.00	44.42	O
ATOM	3030	N	ILE	A	423	91.279	58.974	13.611	1.00	44.45	N
ATOM	3031	CA	ILE	A	423	90.954	59.045	12.196	1.00	43.46	C
ATOM	3032	C	ILE	A	423	92.129	59.498	11.321	1.00	42.96	C
ATOM	3033	O	ILE	A	423	93.178	59.916	11.821	1.00	41.95	O
ATOM	3034	CB	ILE	A	423	89.703	59.963	11.970	1.00	43.06	C
ATOM	3035	CG1	ILE	A	423	89.978	61.412	12.403	1.00	42.83	C
ATOM	3036	CG2	ILE	A	423	88.534	59.439	12.788	1.00	41.55	O
ATOM	3037	CD1	ILE	A	423	90.868	62.208	11.461	1.00	43.42	C
ATOM	3038	N	GLU	A	424	91.934	59.387	10.012	1.00	42.19	N
ATOM	3039	CA	GLU	A	424	92.931	59.775	9.024	1.00	42.21	C
ATOM	3040	C	GLU	A	424	92.422	61.047	8.363	1.00	41.48	C
ATOM	3041	O	GLU	A	424	91.266	61.110	7.945	1.00	41.26	O
ATOM	3042	CB	GLU	A	424	93.071	58.680	7.963	1.00	43.26	C
ATOM	3043	CG	GLU	A	424	93.518	57.325	8.492	1.00	45.35	C
ATOM	3044	CD	GLU	A	424	93.357	56.225	7.453	1.00	46.93	C
ATOM	3045	OE1	GLU	A	424	93.818	56.423	6.305	1.00	48.20	O
ATOM	3046	OE2	GLU	A	424	92.780	55.162	7.780	1.00	46.63	O
ATOM	3047	N	GLY	A	425	93.276	62.060	8.270	1.00	41.08	N
ATOM	3048	CA	GLY	A	425	92.857	63.303	7.643	1.00	40.46	C
ATOM	3049	C	GLY	A	425	93.976	64.030	6.920	1.00	40.17	C
ATOM	3050	O	GLY	A	425	95.017	63.446	6.609	1.00	39.82	O

TABLE 7-continued

ATOM	3051	N	ARG	A	426	93.757	65.309	6.643	1.00	39.48	N
ATOM	3052	CA	ARG	A	426	94.753	66.117	5.967	1.00	39.94	C
ATOM	3053	C	ARG	A	426	94.571	67.562	6.375	1.00	40.26	C
ATOM	3054	O	ARG	A	426	93.486	67.963	6.792	1.00	41.45	O
ATOM	3055	CB	ARG	A	426	94.608	65.989	4.452	1.00	39.82	C
ATOM	3056	CG	ARG	A	426	93.320	66.554	3.892	1.00	41.77	C
ATOM	3057	CD	ARG	A	426	93.202	66.182	2.405	1.00	43.77	C
ATOM	3058	NE	ARG	A	426	92.026	66.747	1.751	1.00	45.14	N
ATOM	3059	CZ	ARG	A	426	91.654	66.455	0.506	1.00	46.18	C
ATOM	3060	NH1	ARG	A	426	92.366	65.604	-0.218	1.00	46.99	N
ATOM	3061	NH2	ARG	A	426	90.577	67.021	-0.021	1.00	47.23	N
ATOM	3062	N	VAL	A	427	95.640	68.342	6.267	1.00	40.61	N
ATOM	3063	CA	VAL	A	427	95.592	69.759	6.613	1.00	40.23	C
ATOM	3064	C	VAL	A	427	96.338	70.557	5.548	1.00	40.03	C
ATOM	3065	O	VAL	A	427	97.235	70.033	4.885	1.00	39.67	O
ATOM	3066	CE	VAL	A	427	96.225	70.029	8.001	1.00	39.28	C
ATOM	3067	CG1	VAL	A	427	95.457	69.280	9.079	1.00	37.97	C
ATOM	3068	CG2	VAL	A	427	97.681	69.609	7.993	1.00	39.20	C
ATOM	3069	N	ALA	A	429	95.945	71.815	5.381	1.00	40.23	N
ATOM	3070	CA	ALA	A	428	96.562	72.700	4.406	1.00	41.04	C
ATOM	3071	C	ALA	A	428	98.079	72.829	4.595	1.00	42.53	C
ATOM	3072	O	ALA	A	428	98.578	72.780	5.727	1.00	42.82	O
ATOM	3073	CB	ALA	A	428	95.918	74.074	4.496	1.00	39.46	C
ATOM	3074	N	TYR	A	429	98.801	72.975	3.480	1.00	42.74	N
ATOM	3075	CA	TYR	A	429	100.251	73.168	3.491	1.00	43.20	C
ATOM	3076	C	TYR	A	429	100.546	74.452	4.284	1.00	42.09	C
ATOM	3077	O	TYR	A	429	99.986	75.509	3.984	1.00	41.87	O
ATOM	3078	CB	TYR	A	429	100.757	73.332	2.061	1.00	44.90	C
ATOM	3079	CG	TYR	A	429	102.211	73.730	1.972	1.00	48.81	C
ATOM	3080	CD1	TYR	A	429	103.228	72.842	2.329	1.00	50.14	C
ATOM	3081	CD2	TYR	A	429	102.574	75.005	1.541	1.00	49.88	C
ATOM	3082	CE1	TYR	A	429	104.575	73.214	2.255	1.00	50.62	C
ATOM	3083	CE2	TYR	A	429	103.915	75.388	1.463	1.00	50.81	C
ATOM	3084	CZ	TYR	A	429	104.908	74.487	1.819	1.00	50.86	C
ATOM	3085	OH	TYR	A	429	106.226	74.863	1.718	1.00	50.47	O
ATOM	3086	N	LYS	A	430	101.429	74.372	5.276	1.00	40.05	N
ATOM	3087	CA	LYS	A	430	101.727	75.541	6.102	1.00	38.56	C
ATOM	3088	C	LYS	A	430	103.086	76.198	5.889	1.00	37.11	C
ATOM	3089	O	LYS	A	430	103.360	77.238	6.486	1.00	37.51	O
ATOM	3090	CB	LYS	A	430	101.610	75.178	7.589	1.00	38.70	C
ATOM	3091	CG	LYS	A	430	100.294	74.563	7.981	1.00	38.40	C
ATOM	3092	CD	LYS	A	430	100.284	74.152	9.434	1.00	38.43	C
ATOM	3093	CE	LYS	A	430	98.997	73.409	9.738	1.00	39.27	C
ATOM	3094	NZ	LYS	A	430	98.927	72.970	11.149	1.00	40.88	N
ATOM	3095	N	GLY	A	431	103.942	75.609	5.063	1.00	35.54	N
ATOM	3096	CA	GLY	A	431	105.256	76.199	4.867	1.00	32.89	C
ATOM	3097	C	GLY	A	431	106.199	75.798	5.991	1.00	31.20	C
ATOM	3098	O	GLY	A	431	105.927	74.847	6.710	1.00	30.24	C
ATOM	3099	N	ALA	A	432	107.296	76.528	6.157	1.00	30.60	N
ATOM	3100	CA	ALA	A	432	108.290	76.214	7.189	1.00	29.98	C
ATOM	3101	C	ALA	A	432	107.759	76.197	8.618	1.00	29.06	C
ATOM	3102	O	ALA	A	432	106.981	77.057	9.018	1.00	30.18	O
ATOM	3103	CB	ALA	A	432	109.462	77.188	7.097	1.00	29.00	C
ATOM	3104	N	ALA	A	433	108.206	75.216	9.390	1.00	27.87	N
ATOM	3105	CA	ALA	A	433	107.798	75.077	10.777	1.00	27.30	C
ATOM	3106	C	ALA	A	433	108.341	76.225	11.624	1.00	27.35	C
ATOM	3107	O	ALA	A	433	107.727	76.611	12.620	1.00	27.15	O
ATOM	3108	CB	ALA	A	433	108.289	73.739	11.333	1.00	28.08	C
ATOM	3109	N	SER	A	434	109.493	76.766	11.238	1.00	26.71	N
ATOM	3110	CA	SER	A	434	110.085	77.875	11.983	1.00	27.06	C
ATOM	3111	C	SER	A	434	109.131	79.070	12.036	1.00	26.79	C
ATOM	3112	O	SER	A	434	109.120	79.821	13.014	1.00	25.57	O
ATOM	3113	CB	SER	A	434	111.419	76.306	11.357	1.00	27.17	C
ATOM	3114	OG	SER	A	434	111.252	78.778	10.031	1.00	28.63	O
ATOM	3115	N	ASP	A	435	108.333	79.243	10.986	1.00	27.24	N
ATOM	3116	CA	ASP	A	435	107.363	80.333	10.928	1.00	28.29	C
ATOM	3117	C	ASP	A	435	106.188	80.060	11.868	1.00	27.92	C
ATOM	3118	O	ASP	A	435	105.714	80.959	12.565	1.00	28.07	O
ATOM	3119	CB	ASP	A	435	106.876	80.517	9.491	1.00	31.68	C
ATOM	3120	CG	ASP	A	435	107.949	81.120	8.579	1.00	35.77	C
ATOM	3121	OD1	ASP	A	435	107.761	81.087	7.341	1.00	38.23	O
ATOM	3122	OD2	ASP	A	435	108.968	81.643	9.096	1.00	36.12	O
ATOM	3123	N	ILE	A	436	105.726	78.815	11.886	1.00	26.54	N
ATOM	3124	CA	ILE	A	436	104.637	78.398	12.763	1.00	25.99	C
ATOM	3125	C	ILE	A	436	105.085	78.679	14.199	1.00	24.91	C
ATOM	3126	O	ILE	A	436	104.388	79.320	14.977	1.00	23.37	O
ATOM	3127	CB	ILE	A	436	104.357	76.867	12.617	1.00	26.46	C
ATOM	3128	CG1	ILE	A	436	104.016	76.524	11.166	1.00	28.02	C
ATOM	3129	CG2	ILE	A	436	103.236	76.437	13.536	1.00	26.46	C

TABLE 7-continued

ATOM	3130	CD1	ILE	A	436	102.860	77.292	10.604	1.00	30.24	C
ATOM	3131	N	VAL	A	437	106.268	76.191	14.539	1.00	25.92	N
ATOM	3132	CA	VAL	A	437	106.804	78.383	15.877	1.00	27.27	C
ATOM	3133	C	VAL	A	437	106.902	79.853	16.244	1.00	28.27	C
ATOM	3134	O	VAL	A	437	106.560	80.238	17.367	1.00	29.71	O
ATOM	3135	CB	VAL	A	437	108.200	77.747	16.022	1.00	26.18	C
ATOM	3136	CG1	VAL	A	437	108.770	78.055	17.395	1.00	25.87	C
ATOM	3137	CG2	VAL	A	437	108.105	76.244	15.821	1.00	26.99	C
ATOM	3138	N	PHE	A	438	107.367	80.678	15.307	1.00	29.44	N
ATOM	3139	CA	PHE	A	438	107.513	82.104	15.564	1.00	29.34	C
ATOM	3140	C	PHE	A	438	106.182	82.759	15.872	1.00	29.77	C
ATOM	3141	O	PHE	A	438	106.110	83.647	16.721	1.00	29.60	O
ATOM	3142	CE	PHE	A	438	108.183	82.799	14.382	1.00	30.41	C
ATOM	3143	CG	PHE	A	436	108.391	84.262	14.589	1.00	32.43	C
ATOM	3144	CD1	PHE	A	438	107.342	85.160	14.424	1.00	34.66	C
ATOM	3145	CD2	PHE	A	438	109.625	84.742	15.012	1.00	34.35	C
ATOM	3146	CE1	PHE	A	438	107.514	86.522	14.678	1.00	35.25	C
ATOM	3147	CE2	PHE	A	438	109.816	86.100	15.273	1.00	35.59	C
ATOM	3148	CZ	PHE	A	438	108.752	86.994	15.105	1.00	36.08	C
ATOM	3149	N	GLN	A	439	105.125	82.325	15.189	1.00	31.03	N
ATOM	3150	CA	GLN	A	439	103.801	82.885	15.440	1.00	31.99	C
ATOM	3151	C	GLN	A	439	103.280	82.473	16.803	1.00	32.50	C
ATOM	3152	O	GLN	A	439	102.669	83.282	17.502	1.00	33.67	O
ATOM	3153	CB	GLN	A	439	102.801	82.454	14.369	1.00	33.33	C
ATOM	3154	CG	GLN	A	439	102.962	83.175	13.052	1.00	36.37	C
ATOM	3155	CD	GLN	A	439	102.863	84.685	13.204	1.00	38.29	C
ATOM	3156	NE1	GLN	A	439	101.882	85.212	13.746	1.00	39.62	O
ATOM	3157	NE2	GLN	A	439	103.880	85.393	12.720	1.00	39.30	N
HETATM	3158	N	MSE	A	440	103.519	81.225	17.199	1.00	31.91	N
HETATM	3159	CA	MSE	A	440	103.036	80.797	18.498	1.00	32.48	C
HETATM	3160	C	MSE	A	440	103.802	81.394	19.682	1.00	30.42	C
HETATM	3161	O	MSE	A	440	103.199	81.680	20.718	1.00	29.98	O
HETATM	3162	CB	MSE	A	440	102.958	79.261	18.577	1.00	36.61	C
HETATM	3163	CG	MSE	A	440	104.200	78.483	18.205	1.00	44.35	C
HETATM	3164	SE	MSE	A	440	103.911	76.661	18.242	1.00	53.13	SE
HETATM	3165	CE	MSE	A	440	102.652	76.462	16.958	1.00	51.30	C
ATOM	3166	N	LEU	A	441	105.107	81.620	19.543	1.00	27.53	N
ATOM	3167	CA	LEU	A	441	105.867	82.206	20.648	1.00	25.82	C
ATOM	3168	C	LEU	A	441	105.407	83.644	20.911	1.00	25.88	C
ATOM	3169	O	LEU	A	441	105.348	84.092	22.053	1.00	26.91	O
ATOM	3170	CB	LEU	A	441	107.370	82.194	20.353	1.00	25.33	C
ATOM	3171	CG	LEU	A	441	108.062	80.839	20.155	1.00	25.97	C
ATOM	3172	CD1	LEU	A	441	109.552	81.080	19.937	1.00	25.09	C
ATOM	3173	CD2	LEU	A	441	107.849	79.940	21.362	1.00	25.75	C
ATOM	3174	N	GLY	A	442	105.076	84.366	19.850	1.00	24.13	N
ATOM	3175	CA	GLY	A	442	104.621	85.731	20.019	1.00	23.31	C
ATOM	3176	C	GLY	A	442	103.358	85.780	20.849	1.00	23.82	C
ATOM	3177	O	GLY	A	442	103.200	86.656	21.693	1.00	22.98	O
ATOM	3178	N	GLY	A	443	102.456	84.834	20.605	1.00	24.50	N
ATOM	3179	CA	GLY	A	443	101.207	84.775	21.347	1.00	24.02	C
ATOM	3180	C	GLY	A	443	101.449	84.354	22.781	1.00	24.08	C
ATOM	3181	O	GLY	A	443	100.773	84.822	23.696	1.00	23.64	O
ATOM	3182	N	ILE	A	444	102.419	83.465	22.970	1.00	24.21	N
ATOM	3183	CA	ILE	A	444	102.780	82.979	24.300	1.00	24.08	C
ATOM	3184	C	ILE	A	444	103.376	84.135	25.106	1.00	24.11	C
ATOM	3185	O	ILE	A	444	103.005	84.346	26.261	1.00	23.54	O
ATOM	3186	CB	ILE	A	444	103.798	81.801	24.209	1.00	23.72	C
ATOM	3187	CG1	ILE	A	444	103.152	80.622	23.466	1.00	22.82	C
ATOM	3188	CG2	ILE	A	444	104.241	81.360	25.612	1.00	22.84	C
ATOM	3189	CD1	ILE	A	444	104.110	79.479	23.146	1.00	22.36	C
ATOM	3190	N	ARG	A	445	104.289	84.890	24.500	1.00	23.72	N
ATOM	3191	CA	ARG	A	445	104.883	86.030	25.195	1.00	24.00	C
ATOM	3192	C	ARG	A	445	103.837	87.106	25.514	1.00	23.44	C
ATOM	3193	O	ARG	A	445	103.891	87.721	26.576	1.00	24.01	O
ATOM	3194	CB	ARG	A	445	106.026	86.625	24.372	1.00	22.89	C
ATOM	3195	CG	ARG	A	445	107.275	85.752	24.332	1.00	24.88	C
ATOM	3196	CD	ARG	A	445	105.356	86.373	23.456	1.00	26.53	C
ATOM	3197	NE	ARG	A	445	109.592	85.596	23.462	1.00	27.53	N
ATOM	3198	CZ	ARG	A	445	110.470	85.579	24.464	1.00	30.01	C
ATOM	3199	NH1	ARG	A	445	110.262	86.303	25.561	1.00	28.96	N
ATOM	3200	NH2	ARG	A	445	111.559	84.823	24.372	1.00	29.00	N
ATOM	3201	N	SER	A	446	102.882	87.333	24.615	1.00	23.77	N
ATOM	3202	CA	SER	A	446	101.835	88.322	24.878	1.00	24.75	C
ATOM	3203	C	SER	A	446	100.953	87.831	26.004	1.00	23.48	C
ATOM	3204	O	SER	A	446	100.605	88.585	26.902	1.00	24.41	O
ATOM	3205	CB	SER	A	446	100.953	88.558	23.656	1.00	25.42	C
ATOM	3206	OG	SER	A	446	101.715	89.056	22.574	1.00	34.14	O
ATOM	3207	N	GLY	A	447	100.587	86.559	25.946	1.00	22.70	N
ATOM	3208	CA	GLY	A	447	99.740	85.996	26.974	1.00	23.15	C

TABLE 7-continued

ATOM	3209	C	GLY	A	447	100.366	86.119	28.338	1.00	23.47	C
ATOM	3210	O	GLY	A	447	99.707	86.531	29.288	1.00	24.01	O
HETATM	3211	N	MSE	A	448	101.641	85.754	28.435	1.00	24.62	N
HETATM	3212	CA	MSE	A	448	102.369	85.834	29.693	1.00	25.24	C
HETATM	3213	C	MSE	A	448	102.566	87.302	30.112	1.00	24.99	C
HETATM	3214	O	MSE	A	448	102.632	87.613	31.300	1.00	25.75	O
HETATM	3215	CB	MSE	A	448	103.704	85.090	29.569	1.00	27.58	C
HETATM	3216	CG	MSE	A	448	103.522	83.600	29.220	1.00	31.58	C
HETATM	3217	SE	MSE	A	448	105.040	82.559	29.094	1.00	37.58	SE
HETATM	3218	CE	MSE	A	448	105.621	82.613	30.821	1.00	34.91	C
ATOM	3219	N	GLY	A	449	102.639	88.208	29.145	1.00	24.08	N
ATOM	3220	CA	GLY	A	449	102.770	89.613	29.487	1.00	24.66	C
ATOM	3221	C	GLY	A	449	101.497	90.132	20.154	1.00	25.65	C
ATOM	3222	O	GLY	A	449	101.550	90.876	31.131	1.00	25.66	C
ATOM	3223	N	TYR	A	450	100.341	89.739	29.626	1.00	25.60	N
ATOM	3224	CA	TYR	A	450	99.059	90.166	30.178	1.00	25.77	C
ATOM	3225	C	TYR	A	450	98.831	89.753	31.623	1.00	24.83	C
ATOM	3226	O	TYR	A	450	98.211	90.485	32.375	1.00	25.34	O
ATOM	3227	CB	TYR	A	450	97.899	89.622	29.344	1.00	26.05	C
ATOM	3228	CG	TYR	A	450	97.590	90.402	28.096	1.00	27.41	C
ATOM	3229	CD1	TYR	A	450	97.111	91.706	28.167	1.00	28.14	C
ATOM	3230	CD2	TYR	A	450	97.749	89.826	26.839	1.00	28.61	C
ATOM	3231	CE1	TYR	A	450	96.793	92.419	27.007	1.00	29.06	C
ATOM	3232	CE2	TYR	A	450	97.436	90.530	25.678	1.00	29.51	C
ATOM	3233	CZ	TYR	A	450	96.959	91.822	25.770	1.00	29.28	C
ATOM	3234	OH	TYR	A	450	96.640	92.501	24.618	1.00	30.87	O
ATOM	3235	N	VAL	A	451	99.305	88.576	32.010	1.00	24.89	N
ATOM	3236	CA	VAL	A	451	99.098	88.121	33.376	1.00	25.62	C
ATOM	3237	C	VAL	A	451	100.316	88.418	34.251	1.00	26.97	C
ATOM	3238	O	VAL	A	451	100.343	88.080	35.434	1.00	27.47	O
ATOM	3239	CB	VAL	A	451	98.758	86.605	33.417	1.00	24.80	C
ATOM	3240	CG1	VAL	A	451	97.465	86.346	32.657	1.00	22.49	C
ATOM	3241	CG2	VAL	A	451	99.884	85.787	32.822	1.00	24.04	C
ATOM	3242	N	GLY	A	452	101.318	89.061	33.655	1.00	28.11	N
ATOM	3243	CA	GLY	A	452	102.518	89.425	34.384	1.00	28.84	C
ATOM	3244	C	GLY	A	452	103.396	88.273	34.816	1.00	30.29	C
ATOM	3245	O	GLY	A	452	104.016	88.325	35.873	1.00	30.53	O
ATOM	3246	N	ALA	A	453	103.461	87.231	33.998	1.00	30.98	N
ATOM	3247	CA	ALA	A	453	104.278	86.065	34.312	1.00	31.22	C
ATOM	3248	C	ALA	A	453	105.623	86.177	33.612	1.00	31.80	C
ATOM	3249	O	ALA	A	453	105.694	86.079	32.386	1.00	32.94	O
ATOM	3250	CB	ALA	A	453	103.567	84.800	33.862	1.00	30.42	C
ATOM	3251	N	GLY	A	454	106.686	86.380	4.387	1.00	31.10	N
ATOM	3252	CA	GLY	A	454	108.015	86.497	33.806	1.00	30.70	C
ATOM	3253	C	GLY	A	454	108.595	85.166	33.359	1.00	30.23	C
ATOM	3254	O	GLY	A	454	109.509	85.117	32.534	1.00	29.71	O
ATOM	3255	N	ASP	A	455	108.076	84.086	33.930	1.00	30.07	N
ATOM	3256	CA	ASP	A	455	108.504	82.742	33.583	1.00	30.58	C
ATOM	3257	C	ASP	A	455	107.326	81.825	33.830	1.00	30.31	C
ATOM	3258	O	ASP	A	455	106.353	82.228	34.463	1.00	30.69	O
ATOM	3259	CB	ASP	A	455	109.701	82.290	34.426	1.00	32.56	C
ATOM	3260	CG	ASP	A	455	109.415	82.301	35.919	1.00	34.66	C
ATOM	3261	OD1	ASP	A	455	108.311	81.896	36.331	1.00	36.16	O
ATOM	3262	OD2	ASP	A	455	110.313	82.688	36.694	1.00	38.54	O
ATOM	3263	N	ILE	A	456	107.412	80.593	33.343	1.00	29.95	N
ATOM	3264	CA	ILE	A	456	106.326	79.634	33.502	1.00	30.50	C
ATOM	3265	C	ILE	A	456	105.976	79.367	34.957	1.00	31.87	C
ATOM	3266	O	ILE	A	456	104.820	79.103	35.274	1.00	32.52	O
ATOM	3267	CB	ILE	A	456	106.657	78.302	32.791	1.00	29.40	C
ATOM	3268	CG1	ILE	A	456	106.775	78.555	31.287	1.00	29.89	C
ATOM	3269	CG2	ILE	A	456	105.589	77.259	33.082	1.00	28.25	C
ATOM	3270	CD1	ILE	A	456	107.179	77.342	30.477	1.00	31.58	C
ATOM	3271	N	GLN	A	457	106.964	79.445	35.844	1.00	32.73	N
ATOM	3272	CA	GLN	A	457	106.718	79.207	37.264	1.00	33.99	C
ATOM	3273	C	GLN	A	457	105.672	80.193	37.801	1.00	33.89	C
ATOM	3274	O	GLN	A	457	104.718	79.800	38.477	1.00	33.85	C
ATOM	3275	CB	GLN	A	457	108.021	79.349	38.049	1.00	36.03	C
ATOM	3276	CG	GLN	A	457	107.883	79.030	39.528	1.00	41.19	C
ATOM	3277	CD	GLN	A	457	109.173	79.257	40.300	1.00	44.64	C
ATOM	3278	OE1	GLN	A	457	110.235	78.745	39.930	1.00	46.35	O
ATOM	3279	NE2	GLN	A	457	109.084	80.019	41.386	1.00	46.46	N
ATOM	3280	N	GLU	A	458	105.860	81.475	37.494	1.00	33.67	N
ATOM	3281	CA	GLU	A	458	104.937	82.523	37.925	1.00	32.88	C
ATOM	3282	C	GLU	A	458	103.574	82.270	37.315	1.00	30.94	C
ATOM	3283	O	GLU	A	458	102.542	82.607	37.889	1.00	30.37	O
ATOM	3284	CB	GLU	A	458	105.436	83.899	37.478	1.00	33.84	C
ATOM	3285	CG	GLU	A	458	106.617	84.441	38.255	1.00	36.71	C
ATOM	3286	CD	GLU	A	458	107.151	85.736	37.661	1.00	39.24	C
ATOM	3287	OE1	GLU	A	458	106.336	86.630	37.337	1.00	39.29	O

TABLE 7-continued

ATOM	3288	OE2	GLU	A	458	108.390	85.867	37.532	1.00	41.42	O
ATOM	3289	N	LEU	A	459	103.587	81.673	36.137	1.00	30.11	N
ATOM	3290	CA	LEU	A	459	102.365	81.363	35.424	1.00	29.90	C
ATOM	3291	C	LEU	A	459	101.543	80.371	36.251	1.00	30.10	C
ATOM	3292	O	LEU	A	459	100.340	80.560	36.446	1.00	30.22	O
ATOM	3293	CB	LEU	A	459	102.725	80.779	34.056	1.00	29.44	C
ATOM	3294	CG	LEU	A	459	101.699	80.716	32.938	1.00	28.07	C
ATOM	3295	CD1	LEU	A	459	101.087	82.092	32.708	1.00	27.42	C
ATOM	3296	CD2	LEU	A	459	102.404	80.226	31.689	1.00	26.36	C
ATOM	3297	N	HIS	A	460	102.190	79.322	36.754	1.00	30.22	N
ATOM	3298	CA	HIS	A	460	101.483	78.337	37.561	1.00	30.19	C
ATOM	3299	C	HIS	A	460	100.980	78.973	38.850	1.00	30.56	C
ATOM	3300	O	MIS	A	460	99.824	78.792	39.228	1.00	30.63	O
ATOM	3301	CB	HIS	A	460	102.378	77.138	37.927	1.00	30.63	C
ATOM	3302	CC	MIS	A	460	102.860	76.337	36.753	1.00	31.06	C
ATOM	3303	ND1	HIS	A	460	102.178	76.270	35.558	1.00	31.79	N
ATOM	3304	CD2	HIS	A	460	103.925	75.507	36.620	1.00	31.34	C
ATOM	3305	CE1	HIS	A	460	102.802	75.437	34.742	1.00	31.58	C
ATOM	3306	NE2	HIS	A	460	103.865	74.959	35.361	1.00	30.54	N
ATOM	3307	N	GLU	A	461	101.853	79.733	39.509	1.00	31.26	N
ATOM	3308	CA	GLU	A	461	101.538	80.387	40.789	1.00	32.15	C
ATOM	3309	C	GLU	A	461	100.548	81.562	40.795	1.00	30.88	C
ATOM	3310	O	GLU	A	461	99.740	81.687	41.715	1.00	29.77	O
ATOM	3311	CB	GLU	A	461	102.833	80.887	41.457	1.00	33.27	C
ATOM	3312	CG	GLU	A	461	103.899	79.832	41.728	1.00	35.31	C
ATOM	3313	CD	GLU	A	461	103.422	78.711	42.633	1.00	36.84	C
ATOM	3314	OE1	GLU	A	461	102.952	78.986	43.758	1.00	37.87	O
ATOM	3315	OE2	GLU	A	461	103.533	77.543	42.214	1.00	40.15	O
ATOM	3316	N	ASN	A	462	100.616	82.417	39.779	1.00	29.95	N
ATOM	3317	CA	ASN	A	462	99.779	83.611	39.733	1.00	30.16	C
ATOM	3318	C	ASN	A	462	98.589	83.674	38.774	1.00	29.60	C
ATOM	3319	O	ASN	A	462	97.568	84.282	39.107	1.00	30.16	O
ATOM	3320	CB	ASN	A	462	100.683	84.817	39.484	1.00	31.63	C
ATOM	3321	CG	ASN	A	462	101.759	84.960	40.543	1.00	32.75	C
ATOM	3322	OD1	ASN	A	462	102.725	85.696	40.367	1.00	35.69	O
ATOM	3323	ND2	ASN	A	462	101.588	84.262	41.656	1.00	31.98	N
ATOM	3324	N	ALA	A	463	98.711	83.066	37.598	1.00	27.52	N
ATOM	3325	CA	ALA	A	463	97.634	83.103	36.610	1.00	26.51	C
ATOM	3326	C	ALA	A	463	96.338	82.451	37.076	1.00	25.73	C
ATOM	3327	O	ALA	A	463	96.348	81.386	37.679	1.00	25.89	O
ATOM	3328	CB	ALA	A	463	98.096	82.465	35.313	1.00	24.91	C
ATOM	3329	N	GLN	A	464	95.222	83.113	36.785	1.00	25.80	N
ATOM	3330	CA	GLN	A	464	93.888	82.619	37.136	1.00	25.60	C
ATOM	3331	C	GLN	A	464	92.959	82.601	35.923	1.00	24.30	C
ATOM	3332	C	GLN	A	464	93.147	83.369	34.977	1.00	23.88	O
ATOM	3333	CB	GLN	A	464	93.270	83.492	38.214	1.00	25.18	C
ATOM	3334	CG	GLN	A	464	93.996	83.413	39.517	1.00	28.22	C
ATOM	3335	CD	GLN	A	464	93.378	84.314	40.545	1.00	29.41	C
ATOM	3336	OE1	GLN	A	464	93.378	85.539	40.395	1.00	30.21	O
ATOM	3337	NE2	GLN	A	464	92.829	83.716	41.596	1.00	30.03	N
ATOM	3338	N	PHE	A	465	91.962	81.721	35.959	1.00	22.93	N
ATOM	3339	CA	PHE	A	465	91.009	81.614	34.868	1.00	22.72	C
ATOM	3340	C	PHE	A	465	89.627	82.121	35.246	1.00	23.14	C
ATOM	3341	O	PHE	A	465	89.199	82.035	36.404	1.00	23.64	O
ATOM	3342	CB	PHE	A	465	90.820	80.162	34.415	1.00	22.18	C
ATOM	3343	CG	PHE	A	465	92.042	79.513	33.836	1.00	23.68	C
ATOM	3344	CD1	PHE	A	465	92.775	78.594	34.577	1.00	25.25	C
ATOM	3345	CD2	PHE	A	465	92.437	79.780	32.533	1.00	23.42	C
ATOM	3346	CE1	PHE	A	465	93.884	77.947	34.025	1.00	24.49	C
ATOM	3347	CE2	PHE	A	465	93.544	79.138	31.974	1.00	23.33	C
ATOM	3348	CZ	PHE	A	465	94.265	78.220	32.724	1.00	24.38	C
ATOM	3349	N	VAL	A	466	88.932	82.656	34.251	1.00	22.63	N
ATOM	3350	CA	VAL	A	466	87.556	83.094	34.415	1.00	21.20	C
ATOM	3351	C	VAL	A	466	86.828	82.188	33.423	1.00	21.50	C
ATOM	3352	O	VAL	A	466	87.281	81.994	32.300	1.00	19.95	O
ATOM	3353	CB	VAL	A	466	87.352	84.586	34.061	1.00	19.34	C
ATOM	3354	CG1	VAL	A	466	87.897	84.887	32.698	1.00	18.84	C
ATOM	3355	CG2	VAL	A	466	85.872	84.924	34.123	1.00	18.58	C
ATOM	3356	N	GLU	A	467	85.726	81.601	33.854	1.00	22.06	N
ATOM	3357	CA	GLU	A	467	84.979	80.698	33.005	1.00	24.06	C
ATOM	3358	C	GLU	A	467	84.050	81.439	32.068	1.00	24.75	C
ATOM	3359	O	GLU	A	467	83.415	82.413	32.465	1.00	25.25	O
ATOM	3360	CB	GLU	A	467	84.151	79.763	33.858	1.00	24.21	C
ATOM	3361	CG	GLU	A	467	83.546	78.653	33.077	1.00	28.44	C
ATOM	3362	CD	GLU	A	467	82.524	77.934	33.879	1.00	32.19	C
ATOM	3363	OE1	GLU	A	467	82.756	77.771	35.093	1.00	34.37	O
ATOM	3364	OE2	GLU	A	467	81.502	77.521	33.298	1.00	35.05	O
HETATM	3365	N	MSE	A	468	83.956	80.981	30.826	1.00	24.94	N
HETATM	3366	CA	MSE	A	468	83.066	81.631	29.878	1.00	26.54	C

TABLE 7-continued

HETATM	3367	C	MSE	A	468	82.086	80.645	29.274	1.00	26.74	C
HETATM	3368	O	MSE	A	468	82.353	79.444	29.218	1.00	26.45	O
HETATM	3369	CB	MSE	A	468	83.858	82.322	28.763	1.00	28.88	C
HETATM	3370	CG	MSE	A	468	84.730	81.421	27.918	1.00	31.63	C
HETATM	3371	SE	MSE	A	468	85.425	82.387	26.542	1.00	39.89	SE
HETATM	3372	CE	MSE	A	468	86.595	81.206	25.795	1.00	34.18	C
ATOM	3373	N	SER	A	469	80.945	81.156	28.827	1.00	27.65	N
ATOM	3374	CA	SER	A	469	79.919	80.314	28.212	1.00	28.52	C
ATOM	3375	C	SER	A	469	80.148	80.275	26.705	1.00	29.26	C
ATOM	3376	O	SER	A	469	81.093	80.886	26.197	1.00	28.60	O
ATOM	3377	CB	SER	A	469	78.532	80.888	28.488	1.00	27.30	C
ATOM	3378	OG	SER	A	469	78.385	82.148	27.847	1.00	27.56	O
ATOM	3379	N	GLY	A	470	79.271	79.566	25.996	1.00	31.42	N
ATOM	3380	CA	GLY	A	470	79.384	79.479	24.549	1.00	33.33	C
ATOM	3381	C	GLY	A	470	79.362	80.860	23.920	1.00	35.22	C
ATOM	3382	O	GLY	A	470	80.083	81.131	22.956	1.00	36.54	O
ATOM	3383	N	ALA	A	471	78.530	81.738	24.477	1.00	35.45	N
ATOM	3384	CA	ALA	A	471	78.408	83.106	23.992	1.00	36.13	C
ATOM	3385	C	ALA	A	471	79.720	83.867	24.206	1.00	36.97	C
ATOM	3386	O	ALA	A	471	80.182	84.595	23.321	1.00	37.26	O
ATOM	3387	CB	ALA	A	471	77.268	83.809	24.722	1.00	35.98	C
ATOM	3388	N	GLY	A	472	80.311	83.701	25.388	1.00	37.72	N
ATOM	3389	CA	GLY	A	472	81.565	84.369	25.691	1.00	38.01	C
ATOM	3390	C	GLY	A	472	82.656	83.924	24.730	1.00	38.54	C
ATOM	3391	O	GLY	A	472	83.558	84.695	24.385	1.00	38.01	O
ATOM	3392	N	LEU	A	473	82.573	82.667	24.296	1.00	38.34	N
ATOM	3393	CA	LEU	A	473	83.550	82.125	23.363	1.00	37.79	C
ATOM	3394	C	LEU	A	473	83.349	82.890	22.050	1.00	37.07	C
ATOM	3395	O	LEU	A	473	84.316	83.285	21.395	1.00	36.58	O
ATOM	3396	CB	LEU	A	473	83.306	80.624	23.152	1.00	38.74	C
ATOM	3397	CG	LEU	A	473	84.497	79.733	22.761	1.00	39.23	C
ATOM	3398	CD1	LEU	A	473	83.986	78.347	22.459	1.00	38.60	C
ATOM	3399	CD2	LEU	A	473	85.229	80.274	21.558	1.00	40.46	C
ATOM	3400	N	ILE	A	474	82.084	83.108	21.687	1.00	36.82	N
ATOM	3401	CA	ILE	A	474	81.737	83.841	20.463	1.00	36.70	C
ATOM	3402	C	ILE	A	474	82.348	85.238	20.536	1.00	36.56	C
ATOM	3403	O	ILE	A	474	82.968	85.707	19.582	1.00	36.03	O
ATOM	3404	CB	ILE	A	474	80.198	84.001	20.294	1.00	36.35	C
ATOM	3405	CG1	ILE	A	474	79.516	82.630	20.276	1.00	36.33	C
ATOM	3406	CG2	ILE	A	474	79.889	84.760	19.006	1.00	35.09	C
ATOM	3407	CD1	ILE	A	474	79.989	81.719	19.171	1.00	35.80	C
ATOM	3408	N	GLU	A	475	82.159	85.899	21.674	1.00	35.95	&
ATOM	3409	CA	GLU	A	475	82.700	87.233	21.880	1.00	36.17	C
ATOM	3410	C	GLU	A	475	84.216	87.235	21.791	1.00	36.53	C
ATOM	3411	O	GLU	A	475	84.807	88.209	21.327	1.00	36.42	O
ATOM	3412	CB	GLU	A	475	82.263	87.776	23.254	1.00	37.61	C
ATOM	3413	CG	GLU	A	475	83.143	88.914	23.827	1.00	37.08	C
ATOM	3414	CD	GLU	A	475	82.626	89.458	25.164	1.00	37.58	C
ATOM	3415	OE1	GLU	A	475	81.614	90.188	25.161	1.00	38.57	O
ATOM	2416	OE2	GLU	A	475	83.216	89.146	26.221	1.00	33.85	O
ATOM	2417	N	SER	A	476	84.841	86.145	22.237	1.00	37.04	N
ATOM	2418	CA	SER	A	476	86.300	86.039	22.242	1.00	37.27	C
ATOM	2419	C	SER	A	476	86.924	85.973	20.851	1.00	37.06	C
ATOM	2420	O	SER	A	476	88.046	86.442	20.638	1.00	37.30	O
ATOM	3421	CB	SER	A	476	86.728	84.830	23.068	1.00	36.80	C
ATOM	3422	OG	SER	A	476	86.251	84.963	24.391	1.00	36.30	O
ATOM	3423	N	HIS	A	477	86.197	85.391	19.908	1.00	36.25	N
ATOM	3424	CA	HIS	A	477	86.667	85.288	18.533	1.00	36.22	C
ATOM	3425	C	HIS	A	477	86.181	86.477	17.724	1.00	36.09	C
ATOM	3426	O	HIS	A	477	85.207	87.141	18.100	1.00	34.72	O
ATOM	3427	CB	HIS	A	477	86.132	84.008	17.897	1.00	36.36	C
ATOM	3428	CG	HIS	A	477	86.901	82.789	18.267	1.00	36.15	C
ATOM	3429	ND1	HIS	A	477	88.077	82.440	17.644	1.00	37.86	N
ATOM	3430	CD2	HIS	A	477	86.690	81.858	19.224	1.00	37.82	C
ATOM	3431	CE1	HIS	A	477	88.559	81.343	18.200	1.00	38.68	C
ATOM	3432	NE2	HIS	A	477	87.736	80.969	19.162	1.00	38.42	N
ATOM	3433	N	PRO	A	478	86.865	86.778	16.606	1.00	36.62	N
ATOM	3434	CA	PRO	A	478	86.409	87.910	15.801	1.00	37.52	C
ATOM	3435	C	PRO	A	478	84.974	87.589	15.387	1.00	38.47	C
ATOM	3436	O	PRO	A	478	84.626	86.417	15.192	1.00	37.19	O
ATOM	3437	CB	PRO	A	478	87.391	87.901	14.624	1.00	36.75	C
ATOM	3438	CG	PRO	A	478	88.651	87.370	15.266	1.00	36.00	C
ATOM	3439	CD	PRO	A	478	88.056	86.173	15.987	1.00	36.59	C
ATOM	3440	N	RIS	A	479	84.141	88.617	15.271	1.00	40.10	N
ATOM	3441	CA	HIS	A	479	82.749	88.409	14.898	1.00	41.71	C
ATOM	3442	C	HIS	A	479	82.163	89.607	14.178	1.00	43.00	C
ATOM	3443	O	HIS	A	479	82.691	90.723	14.263	1.00	42.96	O
ATOM	3444	CB	HIS	A	479	81.906	88.138	16.142	1.00	42.19	C
ATOM	3445	CG	HIS	A	479	82.004	89.217	17.175	1.00	42.96	C

TABLE 7-continued

ATOM	3446	ND1	HIS	A	479	83.105	89.373	17.989	1.00	44.02	N
ATOM	3447	CD2	HIS	A	479	81.154	90.221	17.499	1.00	44.12	C
ATOM	3448	CE1	HIS	A	479	82.929	90.423	18.773	1.00	43.65	C
ATOM	3449	NE2	HIS	A	479	81.753	90.956	18.495	1.00	44.04	N
ATOM	3450	N	ASP	A	480	81.055	89.355	13.482	1.00	44.35	N
ATOM	3451	CA	ASP	A	480	80.321	90.373	12.741	1.00	45.86	C
ATOM	3452	C	ASP	A	480	81.196	91.161	11.787	1.00	45.95	C
ATOM	3453	O	ASP	A	480	81.074	92.381	11.676	1.00	46.64	O
ATOM	3454	CB	ASP	A	480	79.631	91.326	13.716	1.00	47.55	C
ATOM	3455	CG	ASP	A	480	78.698	90.601	14.672	1.00	50.07	C
ATOM	3456	OD1	ASP	A	480	77.750	89.935	14.191	1.00	50.68	O
ATOM	3457	OD2	ASP	A	480	78.912	90.698	15.904	1.00	52.11	O
ATOM	3458	N	VAL	A	481	82.083	90.457	11.099	1.00	46.00	N
ATOM	3459	CA	VAL	A	481	82.975	91.093	10.141	1.00	45.97	C
ATOM	3460	C	VAL	A	481	83.437	90.069	9.105	1.00	45.58	C
ATOM	3461	O	VAL	A	481	83.781	88.934	9.438	1.00	44.87	O
ATOM	3462	CB	VAL	A	481	84.199	91.748	10.861	1.00	46.24	C
ATOM	3463	CG1	VAL	A	481	84.888	90.733	11.769	1.00	46.53	C
ATOM	3464	CG2	VAL	A	481	85.177	92.301	9.834	1.00	45.43	C
ATOM	3465	N	GLN	A	482	83.416	90.475	7.842	1.00	45.62	N
ATOM	3466	CA	GLN	A	482	83.822	89.600	6.756	1.00	45.66	C
ATOM	3467	C	GLN	A	482	85.331	89.650	6.600	1.00	45.00	C
ATOM	3468	O	GLN	A	482	85.898	90.706	6.353	1.00	44.56	O
ATOM	3469	CB	GLN	A	482	83.129	90.035	5.466	1.00	46.54	C
ATOM	3470	CG	GLN	A	482	83.384	89.130	4.279	1.00	49.29	C
ATOM	3471	CD	GLN	A	482	82.506	89.489	3.095	1.00	51.02	C
ATOM	3472	OE1	GLN	A	482	81.280	89.447	3.190	1.00	53.04	O
ATOM	3473	NE2	GLN	A	482	83.126	89.847	1.976	1.00	50.81	N
ATOM	3474	N	ILE	A	483	85.977	88.500	6.760	1.00	45.70	N
ATOM	3475	CA	ILE	A	483	87.431	88.406	6.643	1.00	46.40	C
ATOM	3476	C	ILE	A	483	87.797	87.626	5.378	1.00	46.80	C
ATOM	3477	O	ILE	A	483	87.378	86.479	5.209	1.00	47.10	O
ATOM	3478	CB	ILE	A	483	88.045	87.668	7.870	1.00	46.86	C
ATOM	3479	CG1	ILE	A	483	87.565	88.314	9.172	1.00	47.22	C
ATOM	3480	CG2	ILE	A	483	89.566	87.721	7.804	1.00	46.15	C
ATOM	3481	CD1	ILE	A	483	88.107	87.641	10.430	1.00	47.26	C
ATOM	3482	N	THR	A	484	88.573	88.240	4.491	1.00	47.02	N
ATOM	3483	CA	THR	A	484	88.970	87.565	3.258	1.00	47.69	C
ATOM	3484	C	THR	A	484	90.448	87.182	3.316	1.00	47.46	C
ATOM	3485	O	THR	A	484	90.908	86.296	2.599	1.00	46.97	O
ATOM	3486	CB	THR	A	484	88.710	98.453	2.002	1.00	48.12	C
ATOM	3487	CG1	THR	A	484	89.451	89.676	2.114	1.00	49.12	O
ATOM	3488	CG2	THR	A	484	87.219	88.767	1.861	1.00	47.18	C
ATOM	3489	N	ASN	A	485	91.184	87.894	4.171	1.00	47.14	N
ATOM	3490	CA	ASN	A	485	92.605	87.644	4.356	1.00	47.75	C
ATOM	3491	C	ASN	A	485	92.864	87.515	5.854	1.00	47.58	C
ATOM	3492	O	ASN	A	485	92.851	88.507	6.594	1.00	47.74	O
ATOM	3493	CB	ASN	A	485	93.436	88.785	3.767	1.00	48.75	C
ATOM	3494	CG	ASN	A	485	94.934	88.540	3.890	1.00	50.65	C
ATOM	3495	OD1	ASN	A	485	95.453	87.518	3.429	1.00	50.94	O
ATOM	3496	ND2	ASN	A	485	95.636	89.483	4.508	1.00	51.72	N
ATOM	3497	N	GLU	A	486	93.099	86.276	6.281	1.00	46.65	N
ATOM	3498	CA	GLU	A	486	93.332	85.930	7.680	1.00	45.73	C
ATOM	3499	C	GLU	A	486	94.720	86.252	8.207	1.00	45.11	C
ATOM	3500	O	GLU	A	486	95.660	86.465	7.443	1.00	45.20	O
ATOM	3501	CB	GLU	A	486	93.057	84.441	7.867	1.00	46.18	C
ATOM	3502	CG	GLU	A	486	91.649	84.047	7.462	1.00	46.84	C
ATOM	3503	CD	GLU	A	486	91.503	82.556	7.259	1.00	47.48	C
ATOM	3504	OE1	GLU	A	486	90.380	82.105	6.946	1.00	47.47	O
ATOM	3505	OE2	GLU	A	486	92.518	81.838	7.402	1.00	47.64	O
ATOM	3506	N	ALA	A	487	94.835	86.284	9.530	1.00	44.77	N
ATOM	3507	CA	ALA	A	487	96.106	86.563	10.187	1.00	44.41	C
ATOM	3508	C	ALA	A	487	96.892	85.264	10.290	1.00	44.54	C
ATOM	3509	O	ALA	A	487	96.314	84.184	10.407	1.00	43.71	O
ATOM	3510	CB	ALA	A	487	95.867	87.143	11.563	1.00	44.17	C
ATOM	3511	N	PRO	A	488	98.227	85.350	10.227	1.00	45.67	N
ATOM	3512	CA	PRO	A	488	99.083	84.168	10.317	1.00	46.18	C
ATOM	3513	C	PRO	A	488	98.978	83.485	11.675	1.00	46.38	C
ATOM	3514	O	PRO	A	488	99.572	82.434	11.892	1.00	47.49	O
ATOM	3515	CB	PRO	A	488	100.474	84.751	10.064	1.00	46.01	C
ATOM	3516	CG	PRO	A	488	100.351	66.122	10.696	1.00	46.03	C
ATOM	3517	CD	PRO	A	488	99.059	86.551	10.034	1.00	46.59	C
ATOM	3518	N	ASN	A	489	98.218	84.075	12.587	1.00	46.12	N
ATOM	3519	CA	ASN	A	489	98.073	83.499	13.918	1.00	46.19	C
ATOM	3520	C	ASN	A	489	96.604	83.237	14.261	1.00	45.99	C
ATOM	3521	O	ASN	A	489	96.258	82.970	15.415	1.00	45.30	O
ATOM	3522	CB	ASN	A	489	98.712	84.433	14.948	1.00	45.82	C
ATOM	3523	CG	ASN	A	489	97.953	85.736	15.101	1.00	47.05	C
ATOM	3524	OD1	ASN	A	489	97.335	86.229	14.152	1.00	47.80	O

TABLE 7-continued

ATOM	3525	ND2	ASN	A	489	98.019	86.320	16.293	1.00	47.88	N
ATOM	3526	N	TYR	A	490	95.741	83.327	13.253	1.00	45.80	N
ATOM	3527	CA	TYR	A	490	94.319	83.069	13.447	1.00	45.86	C
ATOM	3528	C	TYR	A	490	93.669	82.536	12.168	1.00	46.13	C
ATOM	3529	C	TYR	A	490	93.361	83.295	11.246	1.00	45.86	O
ATOM	3530	CB	TYR	A	490	93.576	84.328	13.916	1.00	44.08	C
ATOM	3531	CG	TYR	A	490	92.148	84.013	14.302	1.00	42.82	C
ATOM	3532	CD1	TYR	A	490	91.871	83.222	15.419	1.00	41.48	C
ATOM	3533	CD2	TYR	A	490	91.080	84.402	13.489	1.00	42.13	C
ATOM	3534	CE1	TYR	A	490	90.570	82.816	15.709	1.00	41.83	C
ATOM	3535	CE2	TYR	A	490	89.776	84.001	13.772	1.00	41.77	C
ATOM	3536	CZ	TYR	A	490	89.529	83.204	14.881	1.00	41.35	C
ATOM	3537	OH	TYR	A	490	88.248	82.771	15.141	1.00	40.05	O
ATOM	3536	N	SER	A	491	93.475	81.220	12.135	1.00	47.86	N
ATOM	3539	CA	SER	A	491	92.880	80.512	11.005	1.00	49.91	C
ATOM	3540	C	SER	A	491	93.583	80.739	9.661	1.00	51.25	C
ATOM	3541	O	SER	A	491	94.408	81.674	9.551	1.00	53.12	O
ATOM	3542	CB	SER	A	491	91.402	80.881	10.887	1.00	50.03	C
ATOM	3543	OG	SER	A	491	90.700	80.462	12.043	1.00	51.19	O
ATOM	3544	N	VAL	A	492	93.288	79.975	8.714	1.00	52.00	N
TER	3545		VAL	A	492						
HETATM	3546	P	IMP		500	96.855	67.484	18.145	1.00	36.20	P
HETATM	3547	O1P	IMP		500	96.567	66.958	16.764	1.00	35.78	O
HETATM	3548	O2P	IMP		500	97.831	68.643	18.107	1.00	37.27	O
HETATM	3549	O3P	IMP		500	95.630	67.848	18.926	1.00	37.73	O
HETATM	3550	O5*	IMP		500	97.576	66.348	19.098	1.00	39.55	C
HETATM	3551	C5*	IMP		500	96.906	65.102	19.379	1.00	43.52	C
HETATM	3552	C4*	IMP		500	97.725	64.188	20.314	1.00	46.38	C
HETATM	3553	O4*	IMP		500	96.849	63.056	20.510	1.00	47.93	O
HETATM	3554	C3*	IMP		500	99.128	63.615	19.896	1.00	47.80	C
HETATM	3555	O3*	IMP		500	100.283	64.165	20.566	1.00	48.27	O
HETATM	3556	C2*	IMP		500	99.063	62.138	20.401	1.00	48.14	C
HETATM	3557	O2*	IMP		500	99.459	61.962	21.777	1.00	47.86	O
HETATM	3558	C1*	IMP		500	97.568	61.820	20.391	1.00	48.84	C
HETATM	3559	N9	IMP		500	97.172	60.952	19.187	1.00	49.35	N
HETATM	3560	C8	IMP		500	97.769	60.762	17.934	1.00	49.94	C
HETATM	3561	N7	IMP		500	96.960	59.811	17.195	1.00	49.47	N
HETATM	3562	C5	IMP		500	95.903	59.489	18.092	1.00	49.72	C
HETATM	3563	C6	IMP		500	94.774	58.548	17.851	1.00	49.49	C
HETATM	3564	O6	IMP		500	94.520	57.868	16.852	1.00	49.17	O
HETATM	3565	N1	IMP		500	93.959	58.521	15.994	1.00	50.36	N
HETATM	3566	C2	IMP		500	94.155	59.256	20.190	1.00	50.39	C
HETATM	3567	N3	IMP		500	95.182	60.067	20.313	1.00	49.12	N
HETATM	3568	C4	IMP		500	96.016	60.150	19.259	1.00	49.43	C
HETATM	3569	O	HOH		501	100.576	78.275	17.774	1.00	32.86	O
HETATM	3570	O	HOH		503	91.095	64.490	36.206	1.00	28.90	O
HETATM	3571	O	HOH		504	94.498	58.629	33.377	1.00	29.01	O
HETATM	3572	O	HOH		505	121.994	54.382	32.283	1.00	29.34	O
HETATM	3573	O	HOH		506	103.325	52.600	39.850	1.00	30.92	O
HETATM	3574	O	HOH		506	114.082	79.200	14.020	1.00	31.09	O
HETATM	3575	O	HOH		509	111.782	75.357	9.474	1.00	41.74	O
HETATM	3576	O	HOH		510	130.431	69.550	6.520	1.00	33.07	O
HETATM	3577	O	HOH		511	139.704	72.872	5.502	1.00	28.29	O
HETATM	3578	O	HOH		512	138.165	79.843	7.558	1.00	37.74	O
HETATM	3579	O	HOH		513	110.012	65.496	9.942	1.00	27.19	O
HETATM	3580	O	HOH		514	95.709	85.791	36.220	1.00	26.84	O
HETATM	3581	O	HOH		515	97.359	70.230	25.703	1.00	26.44	O
HETATM	3582	O	HOH		516	111.343	65.984	36.009	1.00	27.68	O
HETATM	3583	O	HOH		517	92.610	64.734	28.562	1.00	25.19	O
HETATM	3584	O	HOH		518	136.337	83.402	18.230	1.00	44.74	O
HETATM	3585	O	HOH		519	125.872	72.828	24.786	1.00	56.58	O
HETATM	3586	O	HOH		520	123.394	85.143	17.982	1.00	44.83	O
HETATM	3587	O	HOH		521	114.051	75.607	10.822	1.00	28.33	O
HETATM	3588	O	HOH		522	95.439	56.751	21.398	1.00	35.18	O
HETATM	3589	O	HOH		523	126.131	73.771	18.625	1.00	28.52	O
HETATM	3590	O	HOH		524	88.573	61.550	21.356	1.00	35.43	O
HETATM	3591	O	HOH		525	84.159	71.151	29.206	1.00	24.40	O
HETATM	3592	O	HOH		526	133.284	55.863	10.735	1.00	36.12	O
HETATM	3593	O	HOH		527	127.221	75.361	20.788	1.00	31.12	O
HETATM	3594	O	HOH		528	144.500	73.437	21.138	1.00	37.89	O
HETATM	3595	O	HOH		529	104.651	89.119	21.108	1.00	45.21	O
HETATM	3596	O	HOH		530	97.113	80.827	16.767	1.00	29.31	O
HETATM	3597	O	HOH		531	115.587	76.287	34.279	1.00	41.57	O
HETATM	3598	O	HOH		532	110.085	78.952	34.960	1.00	36.98	O
HETATM	3599	O	HOH		533	113.576	64.235	37.324	1.00	44.04	O
HETATM	3600	O	HOH		536	113.308	82.910	26.870	1.00	35.47	O
HETATM	3601	O	HOH		537	135.913	65.420	20.988	1.00	42.04	O
HETATM	3602	O	HOH		538	81.878	61.168	23.889	1.00	37.18	O
HETATM	3603	O	HOH		539	112.973	80.799	18.829	1.00	46.80	O

TABLE 7-continued

HETATM	3604	O	HOH	540	114.422	67.736	18.471	1.00	21.38	O
HETATM	3605	O	HOH	541	149.015	73.669	7.625	1.00	31.27	O
HETATM	3606	O	HOH	542	94.881	66.686	41.661	1.00	28.69	O
HETATM	3607	O	HOH	544	100.410	54.930	42.976	1.00	40.88	O
HETATM	3608	O	HOH	546	123.513	59.702	10.409	1.00	32.15	O
HETATM	3609	O	HOH	547	146.434	72.633	24.076	1.00	36.35	O
HETATM	3610	O	HOH	548	88.886	71.737	36.970	1.00	30.08	O
HETATM	3611	O	HOH	549	107.710	87.920	18.571	1.00	46.77	O
HETATM	3612	O	HOH	550	89.670	63.104	37.776	1.00	47.36	O
HETATM	3613	O	HOH	552	122.692	77.602	19.074	1.00	36.80	O
HETATM	3614	O	HOH	553	98.993	52.226	5.651	1.00	57.87	O
HETATM	3615	O	HOH	554	113.536	82.903	22.647	1.00	41.61	O
HETATM	3616	O	HOH	555	115.587	74.041	10.297	1.00	38.20	O
HETATM	3617	O	HOH	557	98.458	49.507	39.120	1.00	62.44	O
HETATM	3618	O	HOH	558	112.138	63.863	8.254	1.00	24.96	O
HETATM	3619	O	HOH	560	118.847	70.191	28.617	1.00	45.38	O
HETATM	3620	O	HOH	561	146.469	68.284	24.114	1.00	37.59	O
HETATM	3621	O	HOH	562	128.262	63.501	17.485	1.00	38.06	O
HETATM	3622	O	HOH	563	119.639	64.695	7.607	1.00	46.90	O
HETATM	3623	O	HOH	564	103.490	70.881	36.574	1.00	31.68	O
HETATM	3624	O	HOH	565	98.314	86.799	37.005	1.00	30.76	O
HETATM	3625	O	HOH	567	131.484	71.418	23.548	1.00	36.31	O
HETATM	3626	O	HOH	568	76.343	60.795	41.874	1.00	35.52	O
HETATM	3627	O	HOH	569	126.027	59.075	12.269	1.00	43.45	O
HETATM	3628	O	HOH	570	109.042	74.363	33.675	1.00	39.31	O
HETATM	3629	O	HOM	573	80.409	90.280	22.579	1.00	34.21	O
HETATM	3630	O	HOH	574	132.441	66.786	9.212	1.00	43.87	O
HETATM	3631	O	HOH	575	109.944	79.697	32.230	1.00	32.32	O
HETATM	3632	O	HOH	577	144.216	66.858	24.156	1.00	40.46	O
HETATM	3633	O	HOH	578	129.414	81.484	16.530	1.00	61.51	O
HETATM	3634	O	HOH	579	96.972	92.020	39.467	1.00	39.03	O
HETATM	3635	O	HOH	580	94.372	70.562	18.189	1.00	26.74	O
HETATM	3636	O	HOH	581	88.506	73.637	23.695	1.00	31.00	O
HETATM	3637	O	HOH	584	100.007	84.003	17.987	1.00	28.74	O
HETATM	3638	O	HOH	585	121.405	52.600	17.537	1.00	40.20	O
HETATM	3639	O	HOH	588	119.167	48.434	16.339	1.00	65.21	O
HETATM	3640	O	HOH	589	102.348	55.052	4.902	1.00	39.64	O
HETATM	3641	O	HOH	595	97.908	70.027	21.031	1.00	34.06	O
HETATM	3642	O	HOH	596	146.572	53.248	20.725	1.00	45.62	O
HETATM	3643	O	HOH	598	90.443	55.094	8.608	1.00	49.49	O
HETATM	3644	O	HOH	599	109.411	77.677	2.747	1.00	53.11	O
HETATM	3645	O	HOH	600	107.764	45.882	37.351	1.00	45.02	O
HETATM	3646	O	HOH	601	87.454	73.205	28.703	1.00	45.44	O
HETATM	3647	O	HOH	602	80.069	88.678	20.249	1.00	42.72	O
HETATM	3648	O	HOH	603	117.159	79.599	17.309	1.00	30.98	O
HETATM	3649	O	HOH	604	84.446	85.847	6.609	1.00	66.35	O
HETATM	3650	O	HOH	605	142.262	74.880	21.888	1.00	42.69	O
HETATM	3651	O	HOH	606	133.945	64.662	5.678	1.00	39.03	O
HETATM	3652	O	HOH	607	110.322	88.556	20.860	1.00	51.80	O
HETATM	3653	O	HOH	608	118.514	60.464	29.384	1.00	33.39	O
HETATM	3654	O	HOH	609	82.950	78.301	25.302	1.00	33.55	O
HETATM	3655	O	HOH	610	111.407	75.421	34.632	1.00	44.58	O
HETATM	3656	O	HOH	612	96.558	63.438	23.644	1.00	34.09	O
HETATM	3657	O	HOH	613	122.627	63.063	23.597	1.00	26.90	O
HETATM	3658	O	HOH	614	131.169	69.077	14.358	1.00	34.02	O
HETATM	3659	O	HOH	618	96.690	54.179	40.860	1.00	32.89	O
HETATM	3660	O	HOH	619	126.711	73.763	15.905	1.00	32.41	O
HETATM	3661	O	HOH	621	92.253	63.599	39.103	1.00	25.94	O
HETATM	3662	O	HOH	622	97.813	87.700	39.424	1.00	55.96	O
HETATM	3663	O	HOH	623	95.535	56.002	20.767	1.00	65.87	O
HETATM	3664	O	HOH	624	129.489	78.975	20.616	1.00	46.43	O
HETATM	3665	O	HOH	625	119.866	48.017	8.457	1.00	69.76	O
HETATM	3666	O	HOH	627	134.345	53.135	10.168	1.00	47.96	O
HETATM	3667	O	HOH	628	96.130	73.007	12.133	1.00	65.41	O
HETATM	3668	O	HOH	629	87.800	55.819	15.251	1.00	45.94	O
HETATM	3669	O	HOH	630	112.422	70.233	37.715	1.00	55.93	O
HETATM	3670	O	HOH	632	121.366	74.739	24.939	1.00	57.43	O
HETATM	3671	O	HOH	633	101.115	80.540	12.424	1.00	53.67	O
HETATM	3672	O	HOH	634	124.882	64.152	26.715	1.00	65.56	O
HETATM	3673	O	HOH	635	97.480	87.029	5.748	1.00	41.53	O
HETATM	3674	O	HOH	636	98.153	71.085	17.480	1.00	23.05	O
HETATM	3675	O	HOH	638	109.916	53.593	7.340	1.00	60.03	O
HETATM	3676	O	HOH	639	109.356	46.219	43.098	1.00	74.41	O
HETATM	3677	O	HOH	640	123.090	65.562	2.087	1.00	64.16	O
HETATM	3678	O	HOH	641	121.091	58.113	37.981	1.00	53.09	O
HETATM	3679	O	HOH	642	106.879	71.024	39.823	1.00	49.73	O
HETATM	3680	O	HOH	644	125.842	60.086	22.102	1.00	57.75	O
HETATM	3681	O	HOH	645	89.792	80.261	21.919	1.00	65.49	O
HETATM	3682	O	HOH	646	127.581	71.494	10.877	1.00	41.56	O

TABLE 7-continued

HETATM	3683	O	HOH	647	116.711	52.692	38.666	1.00	55.88	O
HETATM	3684	O	HOH	648	137.352	49.806	16.559	1.00	67.37	O
HETATM	3685	O	HOH	649	93.707	89.594	38.028	1.00	28.70	O
HETATM	3686	O	HOH	650	102.722	58.313	7.082	1.00	52.26	O
HETATM	3687	O	HOH	651	99.494	73.756	-9.807	1.00	57.10	O
HETATM	3688	O	HOH	652	100.369	60.404	12.181	1.00	24.56	O
HETATM	3689	O	HOH	653	86.387	73.114	22.271	1.00	36.14	O
HETATM	3690	O	HOH	655	82.774	85.056	16.980	1.00	29.50	O
HETATM	3691	O	HOH	656	138.719	75.750	24.731	1.00	43.44	O
HETATM	3692	O	HOH	657	135.443	63.373	23.553	1.00	62.79	O
HETATM	3693	O	HOH	658	136.532	59.341	22.164	1.00	61.51	O
HETATM	3694	O	HOH	659	112.228	46.754	14.166	1.00	44.56	O
HETATM	3695	O	HOH	661	85.056	77.737	37.011	1.00	51.97	O
HETATM	3696	O	HOH	664	93.862	94.123	24.058	1.00	44.59	O
HETATM	3697	O	HOH	665	125.115	50.268	16.057	1.00	50.48	O
HETATM	3698	O	HOH	666	109.792	82.218	39.304	1.00	41.41	O
HETATM	3699	O	HOH	667	81.419	71.538	32.800	1.00	43.84	O
HETATM	3700	O	HOH	671	100.872	91.979	23.613	1.00	64.05	O
HETATM	3701	O	HOH	672	121.924	64.730	9.693	1.00	40.99	O
HETATM	3702	O	HOH	673	103.164	53.450	45.794	1.00	46.76	O
HETATM	3703	O	HOH	674	112.887	44.758	35.892	1.00	60.15	O
HETATM	3704	O	HOH	675	121.226	52.298	40.410	1.00	59.96	O
HETATM	3705	O	HOH	676	114.778	79.883	12.588	1.00	53.72	O
HETATM	3706	O	HOH	677	111.493	44.375	26.336	1.00	44.91	O
HETATM	3707	O	HOH	680	125.672	77.196	7.641	1.00	62.63	O
HETATM	3708	O	HOH	681	149.427	68.734	21.594	1.00	69.45	O
HETATM	3709	O	HOH	682	130.498	68.890	11.409	1.00	43.07	O
HETATM	3710	O	HOH	684	97.027	74.301	-8.091	1.00	51.74	O
HETATM	3711	O	HOH	685	93.468	57.644	35.310	1.00	25.70	O
HETATM	3712	O	HOH	687	120.082	63.118	33.794	1.00	66.97	O
HETATM	3713	O	HOH	688	91.794	50.180	5.365	1.00	61.88	O
HETATM	3714	O	HOH	691	120.955	66.509	26.956	1.00	57.92	O
HETATM	3715	O	HOH	692	147.976	65.172	14.279	1.00	58.48	O
HETATM	3716	O	HOH	693	90.415	78.310	23.880	1.00	38.31	O
HETATM	3717	O	HOH	694	113.372	43.333	17.881	1.00	68.93	O
HETATM	3718	O	HOH	695	101.223	90.113	38.606	1.00	45.49	O
HETATM	3719	O	HOH	696	108.151	50.895	41.168	1.00	59.49	O
HETATM	3720	O	HOH	697	90.431	44.244	14.620	1.00	43.55	O
HETATM	3721	O	HOH	698	146.554	70.443	18.977	1.00	32.63	O
HETATM	3722	O	HOH	702	107.324	89.479	37.117	1.00	65.35	O
HETATM	3723	O	HOH	706	181.406	55.047	15.937	1.00	56.70	C
HETATM	3724	O	HOH	707	101.778	67.697	-5.655	1.00	34.92	O
HETATM	3725	O	HOH	709	136.699	62.881	-10.241	1.00	53.86	O
HETATM	3726	O	HOH	710	115.523	70.686	9.393	1.00	35.01	O
HETATM	3727	O	HOH	714	140.987	80.163	24.272	1.00	65.37	O
HETATM	3728	O	HOH	715	144.845	70.181	8.359	1.00	45.96	O
HETATM	3729	O	HOH	716	127.420	64.712	10.814	1.00	50.93	O
HETATM	3730	O	HbH	717	112.586	85.955	35.733	1.00	63.37	O
HETATM	3731	O	HOH	718	96.397	65.225	43.866	1.00	54.78	O
HETATM	3732	O	HOH	719	149.381	55.765	8.190	1.00	46.95	O
HETATM	3733	O	HOH	723	115.502	77.990	9.376	1.00	46.76	O
HETATM	3734	O	HOH	725	76.437	79.568	26.459	1.00	59.19	O
HETATM	3735	O	HOH	726	95.324	49.183	27.259	1.00	51.94	O
HETATM	3736	O	HOH	727	111.936	82.375	12.461	1.00	38.86	O
HETATM	3737	O	HOH	728	133.312	81.928	11.453	1.00	51.26	O
HETATM	3738	O	HOH	729	107.996	85.280	18.442	1.00	39.71	O
HETATM	3739	O	HOH	730	148.848	63.651	-10.490	1.00	48.09	O
HETATM	3740	O	HOH	733	134.306	63.018	10.766	1.00	31.65	O
HETATM	3741	O	HOH	735	124.671	60.360	17.610	1.00	52.69	O
HETATM	3742	O	HOH	736	111.727	60.489	42.963	1.00	62.15	O
HETATM	3743	O	HOH	737	134.980	50.157	7.477	1.00	60.92	O
HETATM	3744	O	HOH	738	146.654	76.277	6.833	1.00	40.87	O
HETATM	3745	O	HOH	739	89.251	64.149	19.814	1.00	33.88	O
HETATM	3746	O	HOH	741	105.433	55.341	8.828	1.00	58.55	O
HETATM	3747	O	HOH	749	88.458	78.199	19.817	1.00	66.31	O
HETATM	3748	O	HOH	750	106.898	44.639	18.376	1.00	56.87	O
HETATM	3749	O	HOH	751	105.309	68.078	49.132	1.00	66.24	O
HETATM	3750	O	HOH	752	92.980	48.934	17.873	1.00	42.58	O
HETATM	3751	O	HOH	753	100.420	53.758	15.446	1.00	60.31	O
HETATM	3752	O	HOH	754	120.798	66.196	40.717	1.00	66.93	O
HETATM	3753	O	HOH	755	108.406	89.679	12.448	1.00	61.48	O
HETATM	3754	O	HOH	757	132.463	72.528	4.509	1.00	59.31	O
HETATM	3755	O	HOH	761	127.038	77.545	21.661	1.00	47.91	O
HETATM	3756	O	HOH	762	106.459	50.413	17.617	1.00	59.90	O
HETATM	3757	O	HOH	765	119.622	72.534	26.691	1.00	51.38	O
HETATM	3758	O	HOH	766	118.174	72.450	5.241	1.00	68.42	O
HETATM	3759	O	HOH	768	105.322	87.067	41.471	1.00	68.21	O
HETATM	3760	O	HOH	770	105.218	41.445	29.836	1.00	63.03	O
HETATM	3761	O	HOH	771	83.989	78.004	39.580	1.00	67.38	O

TABLE 7-continued

HETATM	3762	O	HOH	772	148.829	67.245	20.069	1.00	44.56	O
HETATM	3763	O	HOH	773	106.544	84.270	11.229	1.00	40.15	O
HETATM	3764	O	HOH	775	105.699	39.006	23.992	1.00	68.38	O
HETATM	3765	O	HOH	778	114.007	85.900	33.916	1.00	42.88	O
HETATM	3766	O	HOH	780	93.889	60.095	23.291	1.00	62.44	O
HETATM	3767	O	HOH	781	129.215	73.681	21.887	1.00	37.93	O
HETATM	3768	O	HOH	787	81.781	76.779	28.784	1.00	61.15	O
HETATM	3769	O	HOH	788	147.918	62.639	14.966	1.00	39.80	O
HETATM	3770	O	HOH	789	79.084	63.731	35.792	1.00	60.46	O
HETATM	3771	O	HOH	791	106.162	72.361	37.935	1.00	51.27	O
HETATM	3772	O	HOH	793	113.985	72.209	7.836	1.00	54.33	O
HETATM	3773	O	HOH	794	147.561	84.941	11.984	1.00	59.95	O
HETATM	3774	O	HOH	796	117.356	86.976	18.333	1.00	57.65	O
HETATM	3775	O	HOH	797	96.398	58.891	24.526	1.00	48.25	O
HETATM	3776	O	HOH	799	113.947	81.311	24.929	1.00	48.99	O
HETATM	3777	O	HOH	800	130.861	56.862	14.557	1.00	67.81	O
HETATM	3778	O	HOH	803	136.966	56.000	-10.559	1.00	66.93	O
HETATM	3779	O	HOH	807	120.744	54.584	40.505	1.00	65.23	O
HETATM	3780	O	HOH	809	111.191	79.767	14.798	1.00	39.00	O
HETATM	3781	O	HOH	810	100.504	80.761	16.287	1.00	40.40	O
HETATM	3782	O	HOH	812	119.309	46.953	19.630	1.00	58.74	O
HETATM	3783	O	HOH	817	79.924	78.741	21.466	1.00	62.43	O
HETATM	3784	O	HOH	819	114.995	48.374	8.804	1.00	68.51	O
HETATM	3785	O	HOH	823	121.219	69.376	9.088	1.00	61.14	O
HETATM	3786	O	HOH	824	83.259	52.990	49.620	1.00	42.61	O
HETATM	3787	O	HOH	826	73.121	53.007	46.366	1.00	51.95	O
HETATM	3788	O	HOH	829	125.131	57.072	24.888	1.00	43.39	O
HETATM	3789	O	HOH	830	117.478	81.142	25.399	1.00	63.97	O
HETATM	3790	O	HOH	832	118.060	80.843	9.442	1.00	68.90	O
HETATM	3791	O	HOH	833	125.309	81.768	10.259	1.00	36.71	O
HETATM	3792	O	HOH	834	106.669	69.383	1.728	1.00	62.38	O
HETATM	3793	O	HOH	836	134.415	57.557	20.513	1.00	51.26	O
HETATM	3794	O	HOH	837	138.774	48.063	14.052	1.00	62.75	O
HETATM	3795	O	HOH	838	105.034	90.698	36.793	1.00	43.22	O
HETATM	3796	O	HOH	839	94.179	62.599	22.253	1.00	39.73	O
HETATM	3797	O	HOH	840	102.012	56.721	46.229	1.00	49.59	O
HETATM	3798	O	HOH	842	129.445	55.023	4.305	1.00	44.96	O
HETATM	3799	O	HOH	843	95.363	50.937	5.969	1.00	60.45	O
HETATM	3800	O	HOH	847	148.499	52.780	8.080	1.00	60.01	O
HETATM	3801	O	HOH	852	90.466	70.795	38.792	1.00	60.50	O
HETATM	3802	O	HOH	853	138.576	76.612	2.592	1.00	62.24	O
HETATM	3803	O	HOH	855	116.588	74.760	7.223	1.00	60.72	O
HETATM	3804	O	HOH	860	113.703	91.874	24.531	1.00	68.47	O
HETATM	3805	O	HOH	861	130.923	52.830	6.921	1.00	62.84	O
HETATM	3806	O	HOH	862	142.316	48.653	13.579	1.00	50.41	O
HETATM	3807	O	HOH	863	132.567	53.947	3.095	1.00	68.97	O
HETATM	3808	O	HOH	865	100.473	47.680	26.060	1.00	65.28	O
HETATM	3809	O	HOH	866	133.655	75.864	1.041	1.00	69.12	O
HETATM	3810	O	HOH	867	122.519	76.254	7.931	1.00	61.12	O
HETATM	3811	O	HOH	868	84.905	74.842	20.730	1.00	46.62	O
HETATM	3812	O	HOH	869	148.011	52.884	0.797	1.00	66.79	O
HETATM	3813	O	HOH	872	94.647	87.503	38.810	1.00	38.25	O
HETATM	3814	O	HOH	873	101.350	92.083	26.520	1.00	62.62	O
HETATM	3815	O	HOH	875	126.984	55.912	-0.651	1.00	69.71	O
HETATM	3816	O	HOH	878	127.346	68.643	12.063	1.00	33.35	O
HETATM	3817	O	HOH	879	117.590	70.113	8.367	1.00	32.01	O
HETATM	3818	O	HOH	884	94.685	91.830	3.118	1.00	53.98	O
HETATM	3819	O	HOM	886	94.421	91.554	39.231	1.00	35.13	O
HETATM	3820	O	HOH	887	90.370	90.226	5.222	1.00	36.45	O
HETATM	3821	O	HOH	888	138.171	82.094	23.696	1.00	43.62	O
HETATM	3822	O	HOH	890	145.344	74.873	18.144	1.00	52.45	O
HETATM	3823	C	HOH	891	86.699	56.553	44.193	1.00	59.80	O
HETATM	3824	O	HOH	895	110.253	51.388	39.073	1.00	64.37	O
HETATM	3825	O	HOH	899	142.548	59.418	25.624	1.00	68.03	O
HETATM	3826	O	HOH	902	96.309	63.463	47.551	1.00	68.27	O
HETATM	3827	O	HOH	904	103.052	43.719	26.788	1.00	64.56	O
HETATM	3828	O	HOH	905	148.314	72.538	19.514	1.00	53.02	O
HETATM	3829	O	HOH	906	115.081	80.764	15.768	1.00	37.40	O
HETATM	3830	O	HOH	907	111.660	74.882	5.430	1.00	36.15	O
HETATM	3831	O	HOH	908	91.410	88.940	39.058	1.00	40.21	O
HETATM	3832	O	HOH	909	92.100	65.397	41.837	1.00	42.61	O
HETATM	3833	O	HOH	910	135.015	70.210	22.164	1.00	32.10	O
HETATM	3834	O	HOH	911	124.196	60.165	24.502	1.00	68.95	O
HETATM	3835	O	HOH	912	104.972	48.595	38.399	1.00	50.34	O
HETATM	3836	O	HOH	913	143.458	60.042	28.053	1.00	36.04	O
HETATM	3837	O	HOH	916	101.435	59.347	18.933	1.00	50.24	O
HETATM	3838	O	HOH	917	112.207	49.761	38.732	1.00	26.79	O
HETATM	3839	O	HOH	918	129.684	70.406	8.637	1.00	46.40	O
HETATM	3840	O	HOH	921	80.125	93.172	15.865	1.00	52.80	O

TABLE 7-continued

HETATM	3841	O	HOH	922	149.474	69.335	14.961	1.00	54.64	O
HETATM	3842	O	HOH	926	102.735	61.951	20.408	1.00	35.26	O
HETATM	3843	O	HOH	927	70.905	53.569	44.583	1.00	70.52	O
HETATM	3844	O	HOH	929	114.913	79.874	33.698	1.00	57.49	O
HETATM	3845	O	HOH	930	150.193	75.660	8.945	1.00	35.94	O
HETATM	3846	O	HOH	931	108.648	54.745	43.966	1.00	62.03	O
HETATM	3847	O	HOH	936	121.915	58.864	24.758	1.00	55.08	O
HETATM	3848	O	HOH	937	79.417	58.337	48.896	1.00	68.62	O
HETATM	3849	O	HOH	938	113.378	43.843	23.780	1.00	41.09	O
HETATM	3850	O	HOH	939	120.219	59.743	27.131	1.00	44.37	O
HETATM	3851	O	HOH	941	105.234	64.396	-0.669	1.00	73.28	O
HETATM	3852	O	HOH	942	141.057	80.868	-0.762	1.00	67.90	O
HETATM	3853	O	HOH	944	119.413	75.184	6.755	1.00	98.67	O
HETATM	3854	O	HOH	945	95.626	74.384	14.294	1.00	63.69	O
HETATM	3855	O	HOH	946	95.387	53.160	20.326	1.00	59.76	O
HETATM	3856	O	HOH	947	112.354	72.038	3.479	1.00	55.13	O
HETATM	3857	O	HOH	961	116.417	63.126	34.645	1.00	53.04	O
HETATM	3858	O	HOH	962	91.960	70.760	43.791	1.00	62.09	O
HETATM	3859	O	HOH	964	80.831	84.466	14.233	1.00	66.83	O
HETATM	3860	O	HOH	966	111.313	64.422	5.416	1.00	43.56	O
HETATM	3861	O	HOH	968	133.045	80.261	24.904	1.00	59.86	O
HETATM	3862	O	HOH	971	113.856	45.592	40.153	1.00	68.81	O
HETATM	3863	O	HOH	973	149.882	57.333	6.661	1.00	61.17	O
HETATM	3864	O	HOH	974	114.479	45.337	23.893	1.00	48.82	O
HETATM	3865	O	HOH	976	122.683	49.979	23.699	1.00	54.50	O
HETATM	3866	O	HOH	977	107.449	93.037	22.262	1.00	67.52	O
HETATM	3867	O	HOH	980	71.623	55.665	43.963	1.00	50.43	O
HETATM	3868	O	HOH	983	81.115	79.690	16.340	1.00	68.34	O
HETATM	3869	O	HOH	984	146.095	68.641	21.063	1.00	40.33	O
HETATM	3870	O	HOH	989	84.591	87.656	11.809	1.00	61.62	O
HETATM	3871	O	HOH	990	101.284	84.890	35.573	1.00	66.53	O
HETATM	3872	O	HOH	991	132.290	57.405	16.338	1.00	66.86	O
HETATM	3873	O	HOH	992	107.181	71.461	43.131	1.00	68.43	O
HETATM	3874	O	HOH	996	121.732	77.353	22.459	1.00	56.10	O
HETATM	3875	O	HOH	997	123.339	62.223	9.181	1.00	53.79	O
HETATM	3876	O	HOH	999	118.564	57.129	2.150	1.00	64.38	O
HETATM	3877	O	HOH	1002	113.406	85.261	25.792	1.00	54.44	O
HETATM	3878	O	HOH	1003	132.676	51.930	17.206	1.00	68.65	O
HETATM	3879	O	HOH	1006	82.100	75.518	31.280	1.00	51.37	O
HETATM	3880	O	HOH	1007	91.217	86.172	10.703	1.00	68.50	O
HETATM	3881	O	HOH	1011	148.150	63.664	-4.949	1.00	66.39	O
HETATM	3882	O	HOH	1012	108.584	47.618	13.690	1.00	63.35	O
HETATM	3883	O	HOH	1014	104.916	54.259	6.694	1.00	66.63	O
HETATM	3884	O	HOH	1021	127.338	67.350	-0.507	1.00	68.51	O
HETATM	3885	O	HOH	1024	100.255	43.755	35.224	1.00	49.55	O
HETATM	3886	O	HOH	1026	113.002	85.034	18.817	1.00	68.03	O
HETATM	3887	O	HOH	1027	74.446	56.955	41.184	1.00	34.26	O
HETATM	3888	O	HOH	1032	123.923	66.490	27.749	1.00	51.93	O
HETATM	3889	O	HOH	1037	105.661	94.018	14.310	1.00	48.05	O
HETATM	3890	O	HOH	1045	85.110	67.600	42.845	1.00	61.60	O
HETATM	3891	O	HOH	1049	72.485	57.802	45.989	1.00	68.63	O
HETATM	3892	O	HOH	1051	104.785	74.784	39.154	1.00	60.69	C
HETATM	3893	O	HOH	1053	104.639	40.347	24.518	1.00	61.31	O
HETATM	3894	O	HOH	1054	142.840	80.523	20.021	1.00	68.20	O
HETATM	3895	O	HOH	1056	123.658	55.426	39.072	1.00	68.01	O
HETATM	3896	O	HOH	1057	122.409	54.809	6.777	1.00	68.72	O
HETATM	3897	O	HOH	1060	148.405	75.478	20.015	1.00	68.99	O
HETATM	3898	O	HOH	1066	101.285	46.434	21.329	1.00	69.66	O
HETATM	3899	O	HOH	1068	101.265	47.738	38.183	1.00	52.34	O
HETATM	3900	O	HOH	1072	116.191	83.171	15.683	1.00	63.11	O
HETATM	3901	O	HOH	1076	124.162	83.118	19.379	1.00	65.19	O
HETATM	3902	O	HOH	1077	114.649	91.913	27.612	1.00	63.68	O
HETATM	3903	O	HOH	1078	131.138	72.022	1.639	1.00	65.80	O
HETATM	3904	O	HOH	1079	104.565	95.248	23.931	1.00	67.66	O
HETATM	3905	O	HOH	1080	130.600	83.061	14.460	1.00	68.73	O
HETATM	3906	O	HOH	1081	108.024	57.385	44.494	1.00	68.47	O
HETATM	3907	O	HOH	1089	98.180	52.040	22.425	1.00	57.82	O
HETATM	3908	O	HOH	1095	123.035	48.662	12.121	1.00	49.75	O
HETATM	3909	O	HOH	1100	116.951	82.153	13.434	1.00	47.33	O
HETATM	3910	O	HOH	1109	93.000	74.011	11.563	1.00	65.00	O
HETATM	3911	O	HOH	1110	84.826	60.423	43.980	1.00	68.47	O
HETATM	3912	O	HOH	1114	95.995	48.302	8.024	1.00	46.89	O
HETATM	3913	O	HOH	1115	146.331	50.245	-5.119	1.00	55.03	O
HETATM	3914	O	HOH	1117	93.037	80.264	22.271	1.00	36.08	O
HETATM	3915	O	HOH	1118	127.120	59.841	19.240	1.00	36.51	O
HETATM	3916	O	HOH	1123	130.326	80.122	18.283	1.00	54.14	O
HETATM	3917	O	HOH	1127	122.797	71.467	7.444	1.00	61.33	O
HETATM	3918	O	HOH	1128	86.326	63.775	40.835	1.00	65.83	O
HETATM	3919	O	HOH	1129	129.934	60.674	26.265	1.00	67.06	O

TABLE 7-continued

HETATM	3920	O	HOH	1132	91.126	55.593	11.580	1.00	55.91	O
HETATM	3921	O	HOH	1136	131.604	57.222	-9.584	1.00	62.55	O
HETATM	3922	O	HOH	1137	122.963	68.163	16.106	1.00	33.32	O
HETATM	3923	O	HOH	1140	107.890	88.486	9.887	1.00	61.56	C
HETATM	3924	O	HOH	1142	143.969	58.642	-10.289	1.00	69.08	O
HETATM	3925	O	HOH	1143	88.527	78.564	-1.195	1.00	66.36	O
HETATM	3926	O	HOH	1146	109.850	50.598	43.199	1.00	64.27	O
HETATM	3927	O	HOH	1151	112.701	76.952	6.277	1.00	55.30	O
HETATM	3928	O	HOH	1154	102.564	50.394	12.484	1.00	59.53	O
HETATM	3929	O	HOH	1161	95.856	79.770	13.615	1.00	60.09	O
HETATM	3930	O	HOH	1162	149.220	72.694	15.463	1.00	36.11	O
HETATM	3931	O	HOH	1167	134.026	86.608	28.831	1.00	55.75	O
HETATM	3932	O	HOH	1168	137.288	47.676	-0.383	1.00	58.53	O
HETATM	3933	O	HOH	1169	96.461	76.369	-1.039	1.00	40.84	O
HETATM	3934	O	HOH	1170	146.839	76.924	18.226	1.00	62.40	O
HETATM	3935	O	HOH	1173	84.778	62.413	46.009	1.00	56.40	O
HETATM	3936	O	HOH	1174	104.665	61.328	-0.147	1.00	68.18	O
HETATM	3937	O	HOH	1176	148.238	49.557	15.253	1.00	68.84	O
HETATM	3938	O	HOH	1180	96.826	57.686	5.466	1.00	68.82	O
HETATM	3939	O	HOH	1181	97.848	45.596	18.230	1.00	68.53	O
HETATM	3940	O	HOH	1183	105.561	78.152	46.280	1.00	55.13	O
HETATM	3941	O	HOH	1184	148.363	55.663	18.453	1.00	67.78	O
HETATM	3942	O	HOH	1188	117.761	72.763	3.201	1.00	49.39	O
HETATM	3943	O	HOH	1190	129.206	55.861	-5.442	1.00	69.86	O
HETATM	3944	O	HOH	1195	107.481	76.284	39.087	1.00	57.19	O
HETATM	3945	O	HOH	1206	122.685	66.549	4.934	1.00	62.97	O
HETATM	3946	O	HOH	1207	150.879	41.867	5.427	1.00	67.80	O
HETATM	3947	O	HOH	1216	134.077	45.934	8.123	1.00	68.54	O
HETATM	3948	O	HOH	1217	92.702	54.498	4.335	1.00	68.29	O
HETATM	3949	O	HOH	1227	133.307	89.606	16.031	1.00	55.60	O
HETATM	3950	O	HOH	1228	145.314	58.907	23.524	1.00	57.48	O
HETATM	3951	O	HOH	1231	121.333	47.473	28.343	1.00	42.57	O
HETATM	3952	O	HOH	1237	80.672	64.102	43.307	1.00	62.67	O
HETATM	3953	O	HOH	1239	79.197	76.085	29.202	1.00	42.02	O
HETATM	3954	O	HOH	1240	147.532	79.940	6.435	1.00	49.20	O
HETATM	3955	O	HOH	1241	105.341	73.622	43.925	1.00	46.80	O
HETATM	3956	O	HOH	1242	108.748	84.315	11.317	1.00	43.50	O
HETATM	3957	O	HOH	1243	113.748	76.205	13.481	1.00	31.05	O
HETATM	3958	O	HOH	1244	106.486	82.249	41.211	1.00	53.73	O
HETATM	3959	O	HOH	1245	123.229	67.990	30.863	1.00	67.62	O
HETATM	3960	O	HOH	1246	97.244	56.293	3.245	1.00	59.53	O
HETATM	3961	O	HOH	1247	84.115	75.748	18.158	1.00	47.44	O
HETATM	3962	O	HOH	1248	92.641	62.480	43.494	1.00	56.54	O
HETATM	3963	O	HOH	1249	126.850	67.707	7.524	1.00	63.22	O
HETATM	3964	O	HOH	1250	116.737	46.525	9.414	1.00	60.31	O
HETATM	3965	O	HOH	1251	99.435	55.524	20.442	1.00	68.76	O
HETATM	3966	O	HOH	1252	93.533	48.432	11.284	1.00	64.31	O
HETATM	3967	O	HOH	1253	115.458	55.820	8.527	1.00	68.91	O
HETATM	3968	O	HOH	1254	94.383	48.132	30.166	1.00	55.54	O
HETATM	3969	O	HOH	1255	136.004	53.964	17.602	1.00	50.55	O
HETATM	3970	O	HOH	1256	97.765	60.337	0.278	1.00	67.66	O
HETATM	3971	O	HOH	1257	81.887	70.128	40.015	1.00	60.06	O
HETATM	3972	O	HOH	1258	98.568	43.853	36.969	1.00	60.96	O
HETATM	3973	O	HOH	1259	102.312	50.226	23.207	1.00	69.15	O
HETATM	3974	O	HOH	1260	93.845	73.542	7.463	1.00	62.17	O
HETATM	3975	O	HOH	1261	122.247	50.835	30.996	1.00	66.32	O
HETATM	3976	O	HOH	1262	137.839	46.740	1.638	1.00	44.22	O
HETATM	3977	O	HOH	1263	107.295	79.492	3.520	1.00	56.86	O
HETATM	3978	O	HOH	1264	108.339	49.640	21.504	1.00	48.82	O
HETATM	3979	O	HOH	1265	105.132	63.518	48.797	1.00	62.13	O
HETATM	3960	O	HOH	1266	139.420	62.113	23.787	1.00	50.94	O
HETATM	3981	O	HOH	1267	144.043	77.286	3.516	1.00	68.14	O
HETATM	3982	O	HOH	1268	149.733	53.900	4.381	1.00	56.17	O
HETATM	3983	O	HOH	1269	103.004	91.675	22.454	1.00	51.28	O
HETATM	3984	O	HOH	1270	102.342	79.977	8.282	1.00	60.86	O
HETATM	3985	O	HOH	1271	104.432	79.198	8.137	1.00	49.45	O
HETATM	3986	O	HOH	1272	96.642	78.325	15.154	1.00	49.69	O
HETATM	3987	O	HOH	1273	123.113	83.532	10.129	1.00	46.69	O
HETATM	3988	O	HOH	1274	108.924	75.712	35.457	1.00	44.24	O
HETATM	3989	O	HOH	1275	120.284	52.133	13.839	1.00	49.42	O
HETATM	3990	O	HOH	1276	153.804	67.675	3.008	1.00	68.53	C
HETATM	3991	O	HOH	1277	132.756	49.791	2.618	1.00	54.77	O
HETATM	3992	O	HOH	1278	123.687	61.097	-1.686	1.00	66.47	O
HETATM	3993	O	HOH	1279	79.098	85.995	16.502	1.00	68.34	O
HETATM	3994	O	HOH	1280	81.604	77.273	22.663	1.00	51.85	O
HETATM	3995	O	HOH	1281	97.665	46.523	21.377	1.00	66.98	O
HETATM	3996	O	HOH	1282	124.226	53.393	42.604	1.00	56.65	O
HETATM	3997	O	HOH	1283	70.053	51.433	45.374	1.00	31.76	O
HETATM	3998	O	HOH	1284	133.004	59.283	22.298	1.00	51.14	O

TABLE 7-continued

HETATM	3999	O	HOH	1285	110.435	58.745	9.141	1.00	66.24	O
HETATM	4000	O	M0H	1286	131.690	83.699	10.424	1.00	50.89	O
HETATM	4001	O	HOH	1287	87.121	83.954	6.897	1.00	61.10	O
HETATM	4002	O	HOH	1289	103.343	70.654	47.251	1.00	59.87	O
HETATM	4003	O	HOH	1290	151.878	57.545	4.368	1.00	68.93	O
HETATM	4004	O	HOH	1291	109.757	52.533	5.140	1.00	68.61	O
HETATM	4005	O	HOH	1292	137.500	85.244	14.713	1.00	48.53	O
HETATM	4006	O	HOH	1293	99.481	43.592	30.277	1.00	56.76	O
HETATM	4007	O	HOH	1294	79.393	66.499	44.205	1.00	51.03	O
HETATM	4008	O	HOH	1295	93.025	76.731	12.952	1.00	68.06	O
HETATM	4009	O	HOH	1296	104.177	39.636	37.064	1.00	66.28	O
HETATM	4010	C	HOH	1297	131.482	71.092	26.769	1.00	63.53	O
HETATM	4011	O	HOH	1299	108.732	64.733	46.862	1.00	59.61	O
HETATM	4012	O	HOH	1300	85.693	84.234	8.773	1.00	61.29	O
HETATM	4013	O	HOH	1301	130.439	55.137	19.928	1.00	68.52	O
HETATM	4014	O	HOH	1302	126.942	81.225	22.497	1.00	68.12	O
HETATM	4015	O	HOH	1303	85.867	53.208	45.199	1.00	54.32	O
HETATM	4016	O	HOH	1304	104.487	89.634	40.115	1.00	64.91	O
HETATM	4017	O	HOH	1305	106.217	68.163	-1.625	1.00	55.54	O
HETATM	4018	O	HOH	1306	105.015	51.028	40.376	1.00	45.33	O
HETATM	4019	O	HOH	1307	120.170	70.835	39.052	1.00	58.73	O
HETATM	4020	O	HOH	1308	121.326	61.115	30.539	1.00	67.23	O
HETATM	4021	O	HOH	1309	107.923	60.643	46.488	1.00	69.06	O
HETATM	4022	O	HOH	1310	78.786	53.486	48.325	1.00	55.45	O
HETATM	4023	O	HOH	1311	130.804	55.401	22.465	1.00	59.73	O
HETATM	4024	O	HOH	1312	150.487	50.345	12.892	1.00	61.66	O
HETATM	4025	O	HOH	1313	100.834	38.834	32.531	1.00	62.67	O
HETATM	4026	O	HOH	1314	111.244	65.102	1.801	1.00	68.69	O
HETATM	4027	O	HOH	1315	132.117	79.062	22.385	1.00	40.28	O
HETATM	4025	O	HOH	1316	91.048	57.371	42.981	1.00	57.35	O
HETATM	4029	O	HOH	1317	144.712	49.327	0.134	1.00	49.54	O
HETATM	4030	O	HOH	1318	147.789	61.584	-9.156	1.00	68.51	C
HETATM	4031	O	HOH	1319	123.090	61.674	6.437	1.00	69.05	C
HETATM	4032	O	HOH	1320	116.358	60.623	35.690	1.00	69.30	O
HETATM	4033	O	HOH	1321	113.530	91.177	21.954	1.00	52.62	O
HETATM	4034	O	HOH	1322	110.177	74.769	14.221	1.00	65.83	O
HETATM	4035	O	HOH	1323	135.219	50.902	-6.112	1.00	68.00	O
HETATM	4036	O	HOH	1324	121.026	52.096	9.382	1.00	68.04	O
HETATM	4037	O	HOH	1325	86.410	84.214	10.939	1.00	54.69	O
HETATM	4036	O	HOH	1326	92.066	62.207	-0.340	1.00	62.69	O
HETATM	4039	O	HOH	1327	108.159	72.272	1.047	1.00	69.41	C
HETATM	4040	O	HOH	1328	136.575	47.899	9.387	1.00	67.46	O
HETATM	4041	O	HOH	1329	112.693	55.745	39.945	1.00	50.31	O
HETATM	4042	O	HOH	1330	142.437	65.379	-12.250	1.00	63.99	O
HETATM	4043	O	HOH	1331	97.845	53.121	3.695	1.00	68.33	O
HETATM	4044	O	HOH	1332	135.048	60.985	20.232	1.00	43.95	O
HETATM	4045	O	HOH	1334	131.683	75.485	22.258	1.00	35.53	O
HETATM	4046	O	HOH	1335	105.140	83.991	8.520	1.00	63.09	O
HETATM	4047	C	HOH	1336	119.421	70.763	31.673	1.00	42.24	O
HETATM	4048	O	HOH	1337	100.568	48.021	23.330	1.00	49.89	O
HETATM	4049	O	HOH	1338	133.982	54.355	16.339	1.00	62.13	O
HETATM	4050	O	HOH	1339	139.885	47.835	4.658	1.00	63.64	O
HETATM	4051	O	HOH	1340	150.581	62.937	15.908	1.00	63.60	O
HETATM	4052	O	HOH	1341	152.210	51.862	8.757	1.00	61.88	O
HETATM	4053	C	HOH	1342	92.864	62.277	3.434	1.00	57.80	O
HETATM	4054	O	HOH	1343	111.310	79.489	44.276	1.00	67.97	O
HETATM	4055	O	HOH	1344	149.427	48.324	7.299	1.00	59.90	O
HETATM	4056	O	HOH	1345	111.003	79.259	3.914	1.00	66.53	O
HETATM	4057	O	HOH	1346	116.893	54.202	7.477	1.00	47.23	O
HETATM	4058	O	HOH	1347	86.047	83.848	13.378	1.00	53.04	O
HETATM	4059	O	HOH	1348	117.820	76.586	7.356	1.00	57.31	O
HETATM	4060	O	HOH	1349	111.270	97.127	33.425	1.00	48.23	O
HETATM	4061	O	HOH	1350	129.000	77.928	24.673	1.00	44.60	O
HETATM	4062	O	HOH	1351	124.726	89.092	16.877	1.00	59.34	O
HETATM	4063	O	HOH	1352	93.181	64.700	49.080	1.00	52.82	O
HETATM	4064	O	HOH	1353	79.571	72.862	32.787	1.00	68.35	O
HETATM	4065	O	HOH	1354	115.741	90.948	32.009	1.00	48.04	O
HETATM	4066	C	HOH	1356	85.780	75.697	15.005	1.00	50.57	O
HETATM	4067	O	HOH	1357	112.933	95.254	27.038	1.00	44.69	O
CONNECT	403	404								
CONNECT	404	403	405	407						
CONNECT	405	404	406							
CONNECT	406	405								
CONNECT	407	404	408							
CONNECT	408	407	409							
CONNECT	409	408	410							
CONNECT	410	409								
CONNECT	459	460								
CONNECT	460	459	461	463						

TABLE 7-continued

CNECT	461	460	462	
CNECT	462	461		
CNECT	463	460	464	
CNECT	464	463	465	
CNECT	465	464	466	
CNECT	466	465		
CNECT	576	577		
CNECT	577	576	578	580
CNECT	578	577	579	
CNECT	579	578		
CNECT	580	577	581	
CNECT	581	580	582	
CNECT	582	581	583	
CNECT	583	582		
CNECT	882	883		
CNECT	883	882	884	886
CNECT	884	883	885	
CNECT	885	884		
CNECT	886	883	887	
CNECT	887	886	888	
CNECT	888	887	889	
CNECT	889	888		
CNECT	1094	1095		
CNECT	1095	1094	1096	1098
CNECT	1096	1095	1097	
CNECT	1097	1096		
CNECT	1098	1095	1099	
CNECT	1099	1010	1100	
CNECT	1100	1099	1101	
CNECT	1101	1100		
CNECT	1211	1212		
CNECT	1212	1211	1213	1215
CNECT	1213	1212	1214	
CNECT	1214	1213		
CNECT	1215	1212	1216	
CNECT	1216	1215	1217	
CNECT	1217	1216	1218	
CNECT	1218	1217		
CNECT	2707	2708		
CNECT	2708	2707	2709	2711
CNECT	2709	2708	2710	
CNECT	2710	2709		
CNECT	2711	2708	2712	
CNECT	2712	2711	2713	
CNECT	2713	2712	2714	
CNECT	2714	2713		
CNECT	2733	2734		
CNECT	2734	2733	2735	2737
CNECT	2735	2734	2736	
CNECT	2736	2735		
CNECT	2737	2734	2738	
CNECT	2738	2737	2739	
CNECT	2739	2738	2740	
CNECT	2740	2739		
CNECT	2934	2935		
CNECT	2935	2934	2936	2938
CNECT	2936	2935	2937	
CNECT	2937	2936		
CNECT	2938	2935	2939	
CNECT	2939	2938	2940	
CNECT	2940	2939	2941	
CNECT	2941	2940		
CNECT	2970	2971		
CNECT	2971	2970	2972	2974
CNECT	2972	2971	2973	
CNECT	2973	2972		
CNECT	2974	2971	2975	
CNECT	2975	2974	2976	
CNECT	2976	2975	2977	
CNECT	2977	2976		
CNECT	3158	3159		
CNECT	3159	3158	3160	3162
CNECT	3160	3159	3161	
CNECT	3161	3160		
CNECT	3162	3159	3163	
CNECT	3163	3162	3164	
CNECT	3164	3163	3165	
CNECT	3165	3164		
CNECT	3211	3212		

TABLE 7-continued

CONNECT	3212	3211	3213	3215						
CONNECT	3213	3212	3214							
CONNECT	3214	3213								
CONNECT	3215	3212	3216							
CONNECT	3216	3215	3217							
CONNECT	3217	3216	3218							
CONNECT	3218	3217								
CONNECT	3365	3366								
CONNECT	3366	3365	3367	3369						
CONNECT	3367	3366	3368							
CONNECT	3368	3367								
CONNECT	3369	3366	3370							
CONNECT	3370	3369	3371							
CONNECT	3371	3370	3372							
CONNECT	3372	3371								
CONNECT	3546	3547	3548	3549	3550					
CONNECT	3547	3546								
CONNECT	3548	3546								
CONNECT	3549	3546								
CONNECT	3550	3546	3551							
CONNECT	3551	3550	3552							
CONNECT	3552	3551	3553	3554						
CONNECT	3553	3552	3558							
CONNECT	3554	3552	3555	3556						
CONNECT	3555	3554								
CONNECT	3556	3554	3557	3558						
CONNECT	3557	3556								
CONNECT	3558	3553	3556	3559						
CONNECT	3559	3558	3560	3568						
CONNECT	3560	3559	3561							
CONNECT	3561	3560	3562							
CONNECT	3562	3561	3563	3568						
CONNECT	3563	3562	3564	3565						
CONNECT	3564	3563								
CONNECT	3565	3563	3566							
CONNECT	3566	3565	3567							
CONNECT	3567	3566	3568							
CONNECT	3568	3559	3562	3567						
MASTER	437	0	14	18	16	0	1	64066	1	127 37
END										

ATOM	1749	O	ALA	A	228	109.788	55.149	20.153	1.00	28.65	O
ATOM	1750	CB	ALA	A	228	107.697	57.575	20.792	1.00	28.14	C
ATOM	1751	N	VAL	A	229	108.662	54.901	22.091	1.00	30.70	N
ATOM	1752	CA	VAL	A	229	108.654	53.447	22.082	1.00	31.77	C
ATOM	1753	C	VAL	A	229	107.354	53.075	22.785	1.00	33.71	C
ATOM	1754	O	VAL	A	229	106.778	53.897	23.508	1.00	34.20	O
ATOM	1755	CB	VAL	A	229	109.847	52.850	22.876	1.00	31.31	C
ATOM	1756	CG1	VAL	A	229	111.156	53.346	22.298	1.00	31.39	C
ATOM	1757	CG2	VAL	A	229	109.739	53.208	24.357	1.00	31.01	C
ATOM	1758	N	GLY	A	230	106.871	51.858	22.570	1.00	34.88	N
ATOM	1759	CA	GLY	A	230	105.652	51.453	23.240	1.00	35.58	C
ATOM	1760	C	GLY	A	230	105.976	50.476	24.352	1.00	36.88	C
ATOM	1761	O	GLY	A	230	107.100	50.411	24.840	1.00	36.39	O
ATOM	1762	N	VAL	A	231	104.975	49.722	24.772	1.00	39.52	N
ATOM	1763	CA	VAL	A	231	105.176	48.719	25.801	1.00	41.92	C
ATOM	1764	C	VAL	A	231	104.905	47.363	25.140	1.00	43.78	C
ATOM	1765	O	VAL	A	231	103.779	46.858	25.143	1.00	44.73	O
ATOM	1766	CB	VAL	A	231	104.240	48.966	26.997	1.00	41.08	C
ATOM	1767	CG1	VAL	A	231	104.639	50.257	27.691	1.00	40.96	C
ATOM	1768	CG2	VAL	A	231	102.810	49.071	26.526	1.00	40.96	C
ATOM	1769	N	THR	A	232	105.954	46.807	24.538	1.00	44.60	N
ATOM	1770	CA	THR	A	232	105.881	45.532	23.845	1.00	45.87	C
ATOM	1771	C	THR	A	232	107.106	44.710	24.200	1.00	46.68	C
ATOM	1772	O	THR	A	232	107.838	45.059	25.120	1.00	47.51	O
ATOM	1773	CB	THR	A	232	105.842	45.739	22.328	1.00	46.37	C
ATOM	1774	OG1	THR	A	232	107.038	46.404	21.906	1.00	46.75	O
ATOM	1775	CG2	THR	A	232	104.645	46.590	21.946	1.00	46.43	C
ATOM	1776	N	SER	A	233	107.342	43.626	23.468	1.00	48.35	N
ATOM	1777	CA	SER	A	233	108.491	42.768	23.755	1.00	49.99	C
ATOM	1778	C	SER	A	233	109.804	43.315	23.199	1.00	50.98	C
ATOM	1779	O	SER	A	233	110.887	42.949	23.667	1.00	52.13	O
ATOM	1780	CB	SER	A	233	108.256	41.355	23.211	1.00	49.80	C
ATOM	1781	OG	SER	A	233	108.089	41.370	21.809	1.00	51.16	O

-continued

ATOM	1782	N	ASP	A	234	109.710	44.197	22.210	1.00	51.06	N
ATOM	1783	CA	ASP	A	234	110.901	44.779	21.606	1.00	51.16	C
ATOM	1784	C	ASP	A	234	111.207	46.174	22.142	1.00	50.20	C
ATOM	1785	O	ASP	A	234	112.024	46.892	21.570	1.00	50.68	O
ATOM	1786	CB	ASP	A	234	110.733	44.835	20.092	1.00	52.65	C
ATOM	1787	CG	ASP	A	234	109.474	45.563	19.686	1.00	55.59	C
ATOM	1788	OD1	ASP	A	234	108.388	45.134	20.138	1.00	57.24	O
ATOM	1789	OD2	ASP	A	234	109.566	46.556	18.924	1.00	56.62	O
ATOM	1790	N	THR	A	235	110.559	46.553	23.239	1.00	48.92	N
ATOM	1791	CA	THR	A	235	110.775	47.866	23.837	1.00	48.36	C
ATOM	1792	C	THR	A	235	112.219	48.115	24.279	1.00	48.23	C
ATOM	1793	O	THR	A	235	112.835	49.092	23.855	1.00	48.06	O
ATOM	1794	CB	THR	A	235	109.844	48.080	25.035	1.00	48.22	C
ATOM	1795	OG1	THR	A	235	108.492	48.121	24.572	1.00	48.44	O
ATOM	1796	CG2	THR	A	235	110.164	49.382	25.740	1.00	48.44	C
ATOM	1797	N	PHE	A	236	112.755	47.248	25.138	1.00	47.72	N
ATOM	1798	CA	PHE	A	236	114.133	47.403	25.594	1.00	46.43	C
ATOM	1799	C	PHE	A	236	115.075	47.536	24.420	1.00	45.57	C
ATOM	1800	O	PHE	A	236	115.856	48.480	24.342	1.00	45.91	O
ATOM	1801	CB	PHE	A	236	114.568	46.209	26.434	1.00	47.23	C
ATOM	1802	CG	PHE	A	236	114.351	46.394	27.892	1.00	48.55	C
ATOM	1803	CD1	PHE	A	236	115.014	47.402	28.572	1.00	49.39	C
ATOM	1804	CD2	PHE	A	236	113.483	45.567	28.591	1.00	50.16	C
ATOM	1805	CE1	PHE	A	236	114.817	47.588	29.931	1.00	51.05	C
ATOM	1806	CE2	PHE	A	236	113.276	45.742	29.959	1.00	51.03	C
ATOM	1807	CZ	PHE	A	236	113.945	46.755	30.630	1.00	51.13	C
ATOM	1808	N	GLU	A	237	114.998	46.570	23.513	1.00	44.78	N
ATOM	1809	CA	GLU	A	237	115.835	46.548	22.320	1.00	44.06	C
ATOM	1810	C	GLU	A	237	115.749	47.901	21.626	1.00	41.89	C
ATOM	1811	O	GLU	A	237	116.756	48.466	21.210	1.00	41.21	O
ATOM	1812	CB	GLU	A	237	115.334	45.461	21.375	1.00	46.63	C
ATOM	1813	CG	GLU	A	237	116.258	45.132	20.226	1.00	50.92	C
ATOM	1814	CD	GLU	A	237	115.598	44.192	19.233	1.00	54.10	C
ATOM	1815	OE1	GLU	A	237	114.939	43.224	19.686	1.00	55.04	O
ATOM	1816	OE2	GLU	A	237	115.749	44.410	18.004	1.00	55.45	O
ATOM	1817	N	ARG	A	238	114.524	48.410	21.521	1.00	40.47	N
ATOM	1818	CA	ARG	A	238	114.244	49.691	20.880	1.00	39.30	C
ATOM	1819	C	ARG	A	238	114.820	50.864	21.667	1.00	38.27	C
ATOM	1820	O	ARG	A	238	115.508	51.715	21.109	1.00	37.62	O
ATOM	1821	CB	ARG	A	238	112.738	49.888	20.743	1.00	38.03	C
ATOM	1822	CG	ARG	A	238	112.380	50.858	19.656	1.00	38.82	C
ATOM	1823	CD	ARG	A	238	110.901	51.126	19.586	1.00	39.86	C
ATOM	1824	NE	ARG	A	238	110.555	51.547	18.236	1.00	42.82	N
ATOM	1825	CZ	ARG	A	238	110.332	50.707	17.233	1.00	43.08	C
ATOM	1826	NH1	ARG	A	238	110.410	49.402	17.430	1.00	44.36	N
ATOM	1827	NH2	ARG	A	238	110.066	51.170	16.025	1.00	43.46	N
ATOM	1828	N	ALA	A	239	114.518	50.904	22.962	1.00	38.15	N
ATOM	1829	CA	ALA	A	239	114.991	51.960	23.848	1.00	37.99	C
ATOM	1830	C	ALA	A	239	116.516	52.030	23.869	1.00	39.80	C
ATOM	1831	O	ALA	A	239	117.093	53.121	23.815	1.00	39.71	O
ATOM	1832	CB	ALA	A	239	114.461	51.729	25.249	1.00	36.95	C
ATOM	1833	N	GLU	A	240	117.174	50.873	23.944	1.00	41.10	N
ATOM	1834	CA	GLU	A	240	118.631	50.852	23.965	1.00	41.70	C
ATOM	1835	C	GLU	A	240	119.239	51.237	22.621	1.00	40.70	C
ATOM	1836	O	GLU	A	240	120.358	51.744	22.570	1.00	40.79	O
ATOM	1837	CB	GLU	A	240	119.157	49.486	24.428	1.00	44.05	C
ATOM	1838	CG	GLU	A	240	118.629	48.286	23.678	1.00	48.07	C
ATOM	1839	CD	GLU	A	240	119.141	46.973	24.266	1.00	51.41	C
ATOM	1840	OE1	GLU	A	240	119.010	46.776	25.499	1.00	51.93	O
ATOM	1841	OE2	GLU	A	240	119.664	46.135	23.496	1.00	52.53	O
ATOM	1842	N	ALA	A	241	118.508	51.005	21.536	1.00	39.57	N
ATOM	1843	CA	ALA	A	241	118.999	51.373	20.208	1.00	39.09	C
ATOM	1844	C	ALA	A	241	118.911	52.893	20.071	1.00	38.48	C
ATOM	1845	O	ALA	A	241	119.805	53.533	19.521	1.00	38.30	O
ATOM	1846	CB	ALA	A	241	118.161	50.701	19.125	1.00	39.36	C
ATOM	1847	N	LEU	A	242	117.822	53.460	20.579	1.00	37.48	N
ATOM	1848	CA	LEU	A	242	117.603	54.902	20.549	1.00	36.64	C
ATOM	1849	C	LEU	A	242	118.607	55.648	21.421	1.00	36.34	C
ATOM	1850	O	LEU	A	242	119.217	56.620	20.973	1.00	35.49	O
ATOM	1851	CB	LEU	A	242	116.177	55.212	20.999	1.00	36.24	C
ATOM	1852	CG	LEU	A	242	115.079	55.051	19.940	1.00	37.63	C
ATOM	1853	CD1	LEU	A	242	115.390	53.933	18.970	1.00	37.59	C
ATOM	1854	CD2	LEU	A	242	113.748	54.825	20.654	1.00	37.84	C
ATOM	1855	N	PHE	A	243	118.785	55.209	22.666	1.00	36.35	N
ATOM	1856	CA	PHE	A	243	119.749	55.879	23.534	1.00	36.90	C
ATOM	1857	C	PHE	A	243	121.143	55.806	22.930	1.00	37.73	C
ATOM	1858	O	PHE	A	243	121.890	56.781	22.958	1.00	38.96	O
ATOM	1859	CB	PHE	A	243	119.769	55.262	24.938	1.00	35.66	C
ATOM	1860	CG	PHE	A	243	118.619	55.683	25.803	1.00	34.47	C

-continued

ATOM	1861	CD1	PHE	A	243	118.325	57.032	25.980	1.00	34.10	C
ATOM	1862	CD2	PHE	A	243	117.850	54.739	26.474	1.00	33.97	C
ATOM	1863	CE1	PHE	A	243	117.280	57.432	26.818	1.00	33.89	C
ATOM	1864	CE2	PHE	A	243	116.802	55.130	27.317	1.00	33.03	C
ATOM	1865	CZ	PHE	A	243	116.517	56.474	27.489	1.00	32.69	C
ATOM	1866	N	GLU	A	244	121.477	54.650	22.370	1.00	38.32	N
ATOM	1867	CA	GLU	A	244	122.779	54.431	21.763	1.00	39.15	C
ATOM	1868	C	GLU	A	244	122.974	55.304	20.531	1.00	37.76	C
ATOM	1869	O	GLU	A	244	124.103	55.550	20.103	1.00	37.31	O
ATOM	1870	CB	GLU	A	244	122.932	52.959	21.380	1.00	43.06	C
ATOM	1871	CG	GLU	A	244	124.297	52.595	20.823	1.00	48.69	C
ATOM	1872	CD	GLU	A	244	124.375	51.141	20.407	1.00	53.07	C
ATOM	1873	OE1	GLU	A	244	124.097	50.272	21.266	1.00	55.43	O
ATOM	1874	OE2	GLU	A	244	124.713	50.866	19.228	1.00	54.65	O
ATOM	1875	N	ALA	A	245	121.873	55.767	19.951	1.00	36.29	N
ATOM	1876	CA	ALA	A	245	121.964	56.619	18.770	1.00	35.13	C
ATOM	1877	C	ALA	A	245	122.120	58.061	19.224	1.00	33.93	C
ATOM	1878	O	ALA	A	245	122.455	58.935	18.437	1.00	34.56	O
ATOM	1879	CB	ALA	A	245	120.723	56.463	17.897	1.00	35.38	C
ATOM	1880	N	GLY	A	246	121.873	58.301	20.506	1.00	32.96	N
ATOM	1881	CA	GLY	A	246	122.022	59.640	21.039	1.00	32.17	C
ATOM	1882	C	GLY	A	246	120.812	60.256	21.720	1.00	31.72	C
ATOM	1883	O	GLY	A	246	120.919	61.358	22.265	1.00	32.01	O
ATOM	1884	N	ALA	A	247	119.673	59.570	21.710	1.00	30.21	N
ATOM	1885	CA	ALA	A	247	118.465	60.123	22.328	1.00	29.83	C
ATOM	1886	C	ALA	A	247	118.739	60.676	23.718	1.00	29.13	C
ATOM	1887	O	ALA	A	247	119.392	60.038	24.529	1.00	29.36	O
ATOM	1888	CB	ALA	A	247	117.365	59.064	22.398	1.00	29.66	C
ATOM	1889	N	ASP	A	248	118.231	61.874	23.976	1.00	29.42	N
ATOM	1890	CA	ASP	A	248	118.401	62.541	25.262	1.00	29.22	C
ATOM	1891	C	ASP	A	248	117.283	62.141	26.218	1.00	28.93	C
ATOM	1892	O	ASP	A	248	117.334	62.412	27.416	1.00	28.35	O
ATOM	1893	CB	ASP	A	248	118.400	64.049	25.032	1.00	31.00	C
ATOM	1894	CG	ASP	A	248	119.557	64.495	24.153	1.00	33.31	C
ATOM	1895	OD1	ASP	A	248	120.674	64.660	24.689	1.00	34.76	O
ATOM	1896	OD2	ASP	A	248	119.359	64.648	22.922	1.00	33.85	O
ATOM	1897	N	ALA	A	249	116.268	61.487	25.666	1.00	28.79	N
ATOM	1898	CA	ALA	A	249	115.127	61.020	26.439	1.00	28.18	C
ATOM	1899	C	ALA	A	249	114.279	60.097	25.568	1.00	28.88	C
ATOM	1900	O	ALA	A	249	114.314	60.181	24.341	1.00	28.79	O
ATOM	1901	CB	ALA	A	249	114.298	62.209	26.903	1.00	27.25	C
ATOM	1902	N	ILE	A	250	113.543	59.189	26.192	1.00	28.48	N
ATOM	1903	CA	ILE	A	250	112.669	58.324	25.421	1.00	29.55	C
ATOM	1904	C	ILE	A	250	111.260	58.577	25.916	1.00	29.65	C
ATOM	1905	O	ILE	A	250	111.056	58.932	27.085	1.00	29.05	O
ATOM	1906	CB	ILE	A	250	113.000	56.813	25.587	1.00	30.94	C
ATOM	1907	CG1	ILE	A	250	113.023	56.441	27.070	1.00	32.35	C
ATOM	1908	CG2	ILE	A	250	114.303	56.479	24.876	1.00	30.20	C
ATOM	1909	CD1	ILE	A	250	113.296	54.968	27.328	1.00	34.16	C
ATOM	1910	N	VAL	A	251	110.289	58.414	25.024	1.00	29.98	N
ATOM	1911	CA	VAL	A	251	108.894	58.615	25.385	1.00	30.11	C
ATOM	1912	C	VAL	A	251	108.119	57.310	25.254	1.00	31.15	C
ATOM	1913	O	VAL	A	251	107.939	56.777	24.157	1.00	31.33	O
ATOM	1914	CB	VAL	A	251	108.222	59.698	24.499	1.00	29.28	C
ATOM	1915	CG1	VAL	A	251	106.749	59.837	24.869	1.00	28.74	C
ATOM	1916	CG2	VAL	A	251	108.924	61.032	24.689	1.00	28.73	C
ATOM	1917	N	ILE	A	252	107.686	56.791	26.394	1.00	32.25	N
ATOM	1918	CA	ILE	A	252	106.907	55.567	26.445	1.00	34.36	C
ATOM	1919	C	ILE	A	252	105.488	56.052	26.169	1.00	35.92	C
ATOM	1920	O	ILE	A	252	104.796	56.541	27.055	1.00	35.07	O
ATOM	1921	CB	ILE	A	252	107.030	54.933	27.838	1.00	34.93	C
ATOM	1922	CG1	ILE	A	252	108.516	54.658	28.119	1.00	34.36	C
ATOM	1923	CG2	ILE	A	252	106.190	53.662	27.918	1.00	34.35	C
ATOM	1924	CD1	ILE	A	252	108.830	54.276	29.536	1.00	35.76	C
ATOM	1925	N	ASP	A	253	105.084	55.928	24.911	1.00	37.82	N
ATOM	1926	CA	ASP	A	253	103.793	56.405	24.439	1.00	38.30	C
ATOM	1927	C	ASP	A	253	102.759	55.298	24.528	1.00	36.33	C
ATOM	1928	O	ASP	A	253	102.900	54.256	23.897	1.00	35.52	O
ATOM	1929	CB	ASP	A	253	103.969	56.886	22.987	1.00	42.68	C
ATOM	1930	CG	ASP	A	253	103.027	58.024	22.608	1.00	47.26	C
ATOM	1931	OD1	ASP	A	253	103.007	59.059	23.324	1.00	49.54	O
ATOM	1932	OD2	ASP	A	253	102.326	57.895	21.574	1.00	49.50	O
ATOM	1933	N	THR	A	254	101.720	55.535	25.319	1.00	35.67	N
ATOM	1934	CA	THR	A	254	100.654	54.553	25.507	1.00	35.99	C
ATOM	1935	C	THR	A	254	99.267	55.208	25.434	1.00	33.80	C
ATOM	1936	O	THR	A	254	99.115	56.398	25.716	1.00	33.46	O
ATOM	1937	CB	THR	A	254	100.769	53.870	26.894	1.00	37.36	C
ATOM	1938	OG1	THR	A	254	102.127	53.489	27.131	1.00	40.12	O
ATOM	1939	CG2	THR	A	254	99.898	52.617	26.943	1.00	39.58	C

-continued

ATOM	1940	N	ALA	A	255	98.257	54.424	25.076	1.00	32.56	N
ATOM	1941	CA	ALA	A	255	96.901	54.943	25.000	1.00	31.89	C
ATOM	1942	C	ALA	A	255	96.381	55.122	26.419	1.00	31.60	C
ATOM	1943	O	ALA	A	255	95.756	56.131	26.743	1.00	31.27	O
ATOM	1944	CB	ALA	A	255	96.021	53.983	24.239	1.00	31.75	C
ATOM	1945	N	HIS	A	256	96.646	54.133	27.266	1.00	31.05	N
ATOM	1946	CA	HIS	A	256	96.211	54.183	28.652	1.00	30.66	C
ATOM	1947	C	HIS	A	256	97.423	53.961	29.541	1.00	31.22	C
ATOM	1948	O	HIS	A	256	97.811	52.826	29.784	1.00	32.42	O
ATOM	1949	CB	HIS	A	256	95.183	53.092	28.932	1.00	28.92	C
ATOM	1950	CG	HIS	A	256	94.514	53.230	30.263	1.00	28.92	C
ATOM	1951	ND1	HIS	A	256	93.767	52.223	30.832	1.00	29.33	N
ATOM	1952	CD2	HIS	A	256	94.461	54.270	31.128	1.00	28.44	C
ATOM	1953	CB1	HIS	A	256	93.284	52.636	31.991	1.00	29.11	C
ATOM	1954	NE2	HIS	A	256	93.690	53.875	32.194	1.00	29.27	N
ATOM	1955	N	GLY	A	257	98.017	55.043	30.026	1.00	32.56	N
ATOM	1956	CA	GLY	A	257	99.196	54.927	30.871	1.00	33.03	C
ATOM	1957	C	GLY	A	257	98.907	54.494	32.297	1.00	33.73	C
ATOM	1958	O	GLY	A	257	99.825	54.233	33.073	1.00	34.44	O
ATOM	1959	N	HIS	A	258	97.633	54.407	32.655	1.00	33.24	N
ATOM	1960	CA	HIS	A	258	97.277	54.009	34.005	1.00	32.25	C
ATOM	1961	C	HIS	A	258	97.016	52.500	33.995	1.00	33.33	C
ATOM	1962	O	HIS	A	258	96.237	51.991	34.796	1.00	34.50	O
ATOM	1963	CB	HIS	A	258	96.025	54.768	34.447	1.00	30.67	C
ATOM	1964	CG	HIS	A	258	95.892	54.923	35.932	1.00	28.53	C
ATOM	1965	ND1	HIS	A	258	96.576	54.135	36.831	1.00	28.44	N
ATOM	1966	CD2	HIS	A	258	95.100	55.735	36.672	1.00	27.04	C
ATOM	1967	CE1	HIS	A	258	96.212	54.455	38.059	1.00	27.92	C
ATOM	1968	NE2	HIS	A	258	95.316	55.422	37.991	1.00	27.43	N
ATOM	1969	N	SER	A	259	97.664	51.790	33.076	1.00	33.64	N
ATOM	1970	CA	SER	A	259	97.502	50.340	32.974	1.00	35.31	C
ATOM	1971	C	SER	A	259	98.572	49.598	33.765	1.00	35.20	C
ATOM	1972	O	SER	A	259	99.745	49.975	33.751	1.00	35.19	O
ATOM	1973	CB	SER	A	259	97.593	49.883	31.521	1.00	36.71	C
ATOM	1974	OG	SER	A	259	96.600	50.498	30.734	1.00	42.41	O
ATOM	1975	N	ALA	A	260	98.160	48.525	34.434	1.00	35.34	N
ATOM	1976	CA	ALA	A	260	99.075	47.718	35.228	1.00	34.81	C
ATOM	1977	C	ALA	A	260	100.264	47.288	34.377	1.00	34.54	C
ATOM	1978	O	ALA	A	260	101.415	47.394	34.797	1.00	34.57	O
ATOM	1979	CB	ALA	A	260	98.345	46.500	35.769	1.00	34.40	C
ATOM	1980	N	GLY	A	261	99.971	46.808	33.174	1.00	34.40	N
ATOM	1981	CA	GLY	A	261	101.013	46.368	32.271	1.00	33.69	C
ATOM	1982	C	GLY	A	261	102.003	47.458	31.920	1.00	33.68	C
ATOM	1983	O	GLY	A	261	103.211	47.220	31.923	1.00	35.39	O
ATOM	1984	N	VAL	A	262	101.505	48.652	31.612	1.00	31.87	N
ATOM	1985	CA	VAL	A	262	102.372	49.769	31.260	1.00	30.22	C
ATOM	1986	C	VAL	A	262	103.257	50.106	32.453	1.00	30.85	C
ATOM	1987	O	VAL	A	262	104.459	50.296	32.310	1.00	29.76	O
ATOM	1988	CB	VAL	A	262	101.545	51.037	30.851	1.00	29.14	C
ATOM	1989	CG1	VAL	A	262	102.469	52.200	30.517	1.00	25.83	C
ATOM	1990	CG2	VAL	A	262	100.668	50.723	29.653	1.00	28.66	C
ATOM	1991	N	LEU	A	263	102.657	50.170	33.635	1.00	32.42	N
ATOM	1992	CA	LEU	A	263	103.404	50.504	34.842	1.00	35.12	C
ATOM	1993	C	LEU	A	263	104.479	49.449	35.109	1.00	37.28	C
ATOM	1994	O	LEU	A	263	105.579	49.747	35.580	1.00	37.10	O
ATOM	1995	CB	LEU	A	263	102.445	50.611	36.035	1.00	33.85	C
ATOM	1996	CG	LEU	A	263	101.288	51.607	35.876	1.00	32.67	C
ATOM	1997	CD1	LEU	A	263	100.436	51.594	37.126	1.00	31.79	C
ATOM	1998	CD2	LEU	A	263	101.827	53.004	35.615	1.00	31.44	C
ATOM	1999	N	ARG	A	264	104.148	48.208	34.792	1.00	39.38	N
ATOM	2000	CA	ARG	A	264	105.067	47.107	34.981	1.00	41.52	C
ATOM	2001	C	ARG	A	264	106.272	47.304	34.064	1.00	40.90	C
ATOM	2002	O	ARG	A	264	107.410	47.312	34.517	1.00	40.25	O
ATOM	2003	CB	ARG	A	264	104.329	45.804	34.674	1.00	45.25	C
ATOM	2004	CG	ARG	A	264	105.121	44.513	34.813	1.00	50.16	C
ATOM	2005	CD	ARG	A	264	104.144	43.343	34.780	1.00	53.35	C
ATOM	2006	NE	ARG	A	264	103.248	43.420	33.626	1.00	56.71	N
ATOM	2007	CZ	ARG	A	264	102.152	42.681	33.479	1.00	58.23	C
ATOM	2008	NH1	ARG	A	264	101.810	41.805	34.416	1.00	60.06	N
ATOM	2009	NH2	ARG	A	264	101.390	42.821	32.402	1.00	58.84	N
ATOM	2010	N	LYS	A	265	106.010	47.486	32.776	1.00	40.84	N
ATOM	2011	CA	LYS	A	265	107.068	47.684	31.795	1.00	41.03	C
ATOM	2012	C	LYS	A	265	107.915	48.928	32.068	1.00	41.03	C
ATOM	2013	O	LYS	A	265	109.130	48.909	31.885	1.00	42.30	O
ATOM	2014	CB	LYS	A	265	106.461	47.762	30.390	1.00	41.68	C
ATOM	2015	CG	LYS	A	265	107.441	48.146	29.293	1.00	43.10	C
ATOM	2016	CD	LYS	A	265	108.624	47.198	29.235	1.00	45.73	C
ATOM	2017	CE	LYS	A	265	108.175	45.761	29.019	1.00	47.46	C
ATOM	2018	NZ	LYS	A	265	107.382	45.593	27.771	1.00	48.86	N

-continued

ATOM	2019	N	ILE	A	266	107.278	50.009	32.504	1.00	40.38	N
ATOM	2020	CA	ILE	A	266	107.999	51.244	32.783	1.00	39.51	C
ATOM	2021	C	ILE	A	266	108.989	51.061	33.920	1.00	40.45	C
ATOM	2022	O	ILE	A	266	110.124	51.549	33.856	1.00	40.08	O
ATOM	2023	CB	ILE	A	266	107.028	52.396	33.134	1.00	38.28	C
ATOM	2024	CG1	ILE	A	266	106.249	52.809	31.887	1.00	36.55	C
ATOM	2025	CG2	ILE	A	266	107.795	53.572	33.704	1.00	37.78	C
ATOM	2026	CD1	ILE	A	266	105.333	53.963	32.111	1.00	36.83	C
ATOM	2027	N	ALA	A	267	108.553	50.359	34.962	1.00	41.07	N
ATOM	2028	CA	ALA	A	267	109.404	50.105	36.117	1.00	41.67	C
ATOM	2029	C	ALA	A	267	110.584	49.260	35.672	1.00	42.17	C
ATOM	2030	O	ALA	A	267	111.704	49.453	36.141	1.00	42.01	O
ATOM	2031	CB	ALA	A	267	108.621	49.386	37.200	1.00	41.62	C
ATOM	2032	N	GLU	A	268	110.330	48.330	34.757	1.00	42.65	N
ATOM	2033	CA	GLU	A	268	111.386	47.470	34.246	1.00	44.51	C
ATOM	2034	C	GLU	A	268	112.334	48.294	33.383	1.00	44.45	C
ATOM	2035	O	GLU	A	268	113.548	48.064	33.382	1.00	45.38	O
ATOM	2036	CB	GLU	A	268	110.790	46.321	33.429	1.00	46.13	C
ATOM	2037	CG	GLU	A	268	109.741	45.530	34.195	1.00	50.26	C
ATOM	2038	CD	GLU	A	268	109.164	44.377	33.394	1.00	52.59	C
ATOM	2039	OE1	GLU	A	268	108.776	44.587	32.222	1.00	53.91	O
ATOM	2040	OE2	GLU	A	268	109.080	43.260	33.947	1.00	54.82	O
ATOM	2041	N	ILE	A	269	111.780	49.256	32.649	1.00	43.95	N
ATOM	2042	CA	ILE	A	269	112.591	50.117	31.799	1.00	43.12	C
ATOM	2043	C	ILE	A	269	113.450	51.012	32.688	1.00	42.99	C
ATOM	2044	O	ILE	A	269	114.627	51.236	32.402	1.00	42.66	O
ATOM	2045	CB	ILE	A	269	111.716	51.001	30.881	1.00	42.99	C
ATOM	2046	CG1	ILE	A	269	110.944	50.122	29.896	1.00	42.46	C
ATOM	2047	CG2	ILE	A	269	112.590	51.995	30.123	1.00	42.46	C
ATOM	2048	CD1	ILE	A	269	110.036	50.898	38.968	1.00	41.32	C
ATOM	2049	N	ARG	A	270	112.859	51.519	33.768	1.00	42.35	N
ATOM	2050	CA	ARG	A	270	113.592	52.372	34.696	1.00	42.43	C
ATOM	2051	C	ARG	A	270	114.667	51.580	35.447	1.00	43.30	C
ATOM	2052	O	ARG	A	270	115.802	52.033	35.598	1.00	42.17	O
ATOM	2053	CB	ARG	A	270	112.630	53.026	35.689	1.00	40.28	C
ATOM	2054	CG	ARG	A	270	113.335	53.693	36.857	1.00	40.08	C
ATOM	2055	CD	ARG	A	270	114.401	54.661	36.381	1.00	39.52	C
ATOM	2056	NE	ARG	A	270	113.843	55.890	35.835	1.00	39.63	N
ATOM	2057	CZ	ARG	A	270	114.568	56.833	35.246	1.00	40.17	C
ATOM	2058	NH1	ARG	A	270	115.879	56.682	35.127	1.00	39.75	N
ATOM	2059	NH2	ARG	A	270	113.991	57.941	34.803	1.00	41.04	N
ATOM	2060	N	ALA	A	271	114.297	50.393	35.917	1.00	44.99	N
ATOM	2061	CA	ALA	A	271	115.224	49.538	36.638	1.00	46.51	C
ATOM	2062	C	ALA	A	271	116.445	49.281	35.766	1.00	47.60	C
ATOM	2063	O	ALA	A	271	117.550	49.086	36.272	1.00	49.90	O
ATOM	2064	CB	ALA	A	271	114.555	48.222	36.998	1.00	46.57	C
ATOM	2065	N	HIS	A	272	116.254	49.283	34.454	1.00	47.42	N
ATOM	2066	CA	HIS	A	272	117.368	49.048	33.559	1.00	47.00	C
ATOM	2067	C	HIS	A	272	118.096	50.347	33.204	1.00	46.88	C
ATOM	2068	O	HIS	A	272	119.308	50.339	33.009	1.00	47.71	O
ATOM	2069	CB	HIS	A	272	116.889	48.341	32.295	1.00	47.98	C
ATOM	2070	CG	HIS	A	272	117.999	47.783	31.461	1.00	50.44	C
ATOM	2071	ND1	HIS	A	272	117.779	47.130	30.269	1.00	51.34	N
ATOM	2072	CD2	HIS	A	272	119.341	47.762	31.658	1.00	51.66	C
ATOM	2073	CE1	HIS	A	272	118.935	46.730	29.767	1.00	52.07	C
ATOM	2074	NE2	HIS	A	272	119.899	47.101	30.591	1.00	51.04	N
ATOM	2075	N	PHE	A	273	117.370	51.462	33.124	1.00	46.29	N
ATOM	2076	CA	PHE	A	273	117.991	52.755	32.806	1.00	45.64	C
ATOM	2077	C	PHE	A	273	117.810	53.752	33.954	1.00	46.32	C
ATOM	2078	O	PHE	A	273	117.128	54.770	33.797	1.00	47.02	O
ATOM	2079	CB	PHE	A	273	117.386	53.378	31.541	1.00	43.67	C
ATOM	2080	CG	PHE	A	273	117.491	52.519	30.313	1.00	42.54	C
ATOM	2081	CD1	PHE	A	273	116.589	51.489	30.088	1.00	42.71	C
ATOM	2082	CD2	PHE	A	273	118.485	52.755	29.370	1.00	42.26	C
ATOM	2083	CE1	PHE	A	273	116.673	50.709	28.933	1.00	43.23	C
ATOM	2084	CE2	PHE	A	273	118.580	51.981	28.217	1.00	41.40	C
ATOM	2085	CZ	PHE	A	273	117.673	50.959	27.996	1.00	42.59	C
ATOM	2086	N	PRO	A	274	118.431	53.483	35.116	1.00	45.94	N
ATOM	2087	CA	PRO	A	274	118.355	54.329	36.313	1.00	45.40	C
ATOM	2088	C	PRO	A	274	118.763	55.799	36.194	1.00	45.24	C
ATOM	2089	O	PRO	A	274	118.347	56.614	37.011	1.00	45.24	O
ATOM	2090	CB	PRO	A	274	119.229	53.571	37.308	1.00	44.99	C
ATOM	2091	CG	PRO	A	274	120.244	52.905	36.395	1.00	44.50	C
ATOM	2092	CD	PRO	A	274	119.283	52.317	35.400	1.00	45.59	C
ATOM	2093	N	ASN	A	275	119.566	56.145	35.195	1.00	45.09	N
ATOM	2094	CA	ASN	A	275	120.015	57.527	35.042	1.00	45.14	C
ATOM	2095	C	ASN	A	275	119.229	58.295	33.977	1.00	44.49	C
ATOM	2096	O	ASN	A	275	118.967	59.487	34.126	1.00	45.55	O
ATOM	2097	CB	ASN	A	275	121.497	57.563	34.664	1.00	47.44	C

-continued

ATOM	2098	CG	ASN	A	275	122.370	56.762	35.614	1.00	49.31	C
ATOM	2099	OD1	ASN	A	275	122.481	57.076	36.795	1.00	49.47	O
ATOM	2100	ND2	ASN	A	275	123.000	55.713	35.090	1.00	51.15	N
ATOM	2101	N	ARG	A	276	118.869	57.600	32.903	1.00	41.92	N
ATOM	2102	CA	ARG	A	276	118.143	58.183	31.782	1.00	39.15	C
ATOM	2103	C	ARG	A	276	116.868	58.946	32.148	1.00	37.69	C
ATOM	2104	O	ARG	A	276	116.276	58.729	33.206	1.00	37.58	O
ATOM	2105	CB	ARG	A	276	117.793	57.080	30.791	1.00	39.18	C
ATOM	2106	CG	ARG	A	276	118.985	56.271	30.302	1.00	37.60	C
ATOM	2107	CD	ARG	A	276	119.955	57.089	29.463	1.00	36.19	C
ATOM	2108	NE	ARG	A	276	121.019	56.235	28.938	1.00	35.76	N
ATOM	2109	CZ	ARG	A	276	121.913	56.609	28.031	1.00	35.25	C
ATOM	2110	NH1	ARG	A	276	121.887	57.836	27.531	1.00	36.02	N
ATOM	2111	NH2	ARG	A	276	122.831	55.750	27.617	1.00	36.01	N
ATOM	2112	N	THR	A	277	116.461	59.846	31.254	1.00	35.95	N
ATOM	2113	CA	THR	A	277	115.251	60.654	31.429	1.00	33.86	C
ATOM	2114	C	THR	A	277	114.086	59.917	30.790	1.00	32.47	C
ATOM	2115	O	THR	A	277	114.108	59.638	29.587	1.00	31.01	O
ATOM	2116	CB	THR	A	277	115.369	62.023	30.728	1.00	33.80	C
ATOM	2117	OG1	THR	A	277	116.362	62.822	31.381	1.00	34.95	O
ATOM	2118	CG2	THR	A	277	114.039	62.746	30.753	1.00	33.78	C
ATOM	2119	N	LEU	A	278	113.073	59.602	31.588	1.00	30.23	N
ATOM	2120	CA	LEU	A	278	111.915	58.889	31.070	1.00	29.28	C
ATOM	2121	C	LEU	A	278	110.663	59.754	31.048	1.00	28.27	C
ATOM	2122	O	LEU	A	278	110.329	60.404	32.032	1.00	27.31	O
ATOM	2123	CB	LEU	A	278	111.649	57.628	31.893	1.00	28.56	C
ATOM	2124	CG	LEU	A	278	112.782	56.600	31.915	1.00	29.99	C
ATOM	2125	CD1	LEU	A	278	112.339	55.362	32.692	1.00	29.20	C
ATOM	2126	CD2	LEU	A	278	113.159	56.217	30.486	1.00	30.32	C
ATOM	2127	N	ILE	A	279	109.993	59.766	29.900	1.00	26.83	N
ATOM	2128	CA	ILE	A	279	108.759	60.517	29.713	1.00	25.75	C
ATOM	2129	C	ILE	A	279	107.756	59.403	29.451	1.00	26.77	C
ATOM	2130	O	ILE	A	279	108.035	58.499	28.649	1.00	25.38	O
ATOM	2131	CB	ILE	A	279	108.847	61.448	28.485	1.00	23.44	C
ATOM	2132	CG1	ILE	A	279	110.078	62.345	28.598	1.00	23.15	C
ATOM	2133	CG2	ILE	A	279	107.604	62.310	28.405	1.00	24.07	C
ATOM	2134	CD1	ILE	A	279	110.295	63.233	27.412	1.00	23.91	C
ATOM	2135	N	ALA	A	280	106.596	59.449	30.100	1.00	27.48	N
ATOM	2136	CA	ALA	A	280	105.657	58.354	29.914	1.00	30.73	C
ATOM	2137	C	ALA	A	280	104.246	58.667	29.469	1.00	32.08	C
ATOM	2138	O	ALA	A	280	103.726	59.745	29.725	1.00	31.46	O
ATOM	2139	CB	ALA	A	280	105.608	57.495	31.182	1.00	30.65	C
ATOM	2140	N	GLY	A	281	103.665	57.644	28.829	1.00	35.24	N
ATOM	2141	CA	GLY	A	281	102.314	57.614	28.273	1.00	35.20	C
ATOM	2142	C	GLY	A	281	101.303	58.614	28.763	1.00	35.43	C
ATOM	2143	O	GLY	A	281	101.623	59.501	29.552	1.00	37.45	O
ATOM	2144	N	ASN	A	282	100.057	58.467	28.325	1.00	32.74	N
ATOM	2145	CA	ASN	A	282	99.063	59.443	28.729	1.00	29.41	C
ATOM	2146	C	ASN	A	282	98.088	59.056	29.815	1.00	27.37	C
ATOM	2147	O	ASN	A	282	97.590	57.933	29.882	1.00	26.60	O
ATOM	2148	CB	ASN	A	282	98.318	59.939	27.491	1.00	30.24	C
ATOM	2149	CG	ASN	A	282	99.200	60.807	26.595	1.00	31.84	C
ATOM	2150	OD1	ASN	A	282	100.405	60.562	26.467	1.00	32.15	O
ATOM	2151	ND2	ASN	A	282	98.600	61.809	25.949	1.00	32.17	N
ATOM	2152	N	ILE	A	283	97.845	60.019	30.690	1.00	25.51	N
ATOM	2153	CA	ILE	A	283	96.907	59.873	31.790	1.00	24.37	C
ATOM	2154	C	ILE	A	283	96.136	61.185	31.823	1.00	23.61	C
ATOM	2155	O	ILE	A	283	96.532	62.160	31.175	1.00	23.14	O
ATOM	2156	CB	ILE	A	283	97.636	59.631	33.150	1.00	23.62	C
ATOM	2157	CG1	ILE	A	283	98.677	60.727	33.421	1.00	22.08	C
ATOM	2158	CG2	ILE	A	283	98.279	58.256	33.153	1.00	23.25	C
ATOM	2159	CD1	ILE	A	283	98.119	62.094	33.881	1.00	19.86	C
ATOM	2160	N	ALA	A	284	95.039	61.216	32.561	1.00	22.29	N
ATOM	2161	CA	ALA	A	284	94.254	62.426	32.639	1.00	23.16	C
ATOM	2162	C	ALA	A	284	93.744	62.633	34.059	1.00	24.19	C
ATOM	2163	O	ALA	A	284	92.839	63.434	34.300	1.00	25.24	O
ATOM	2164	CB	ALA	A	284	93.102	62.347	31.659	1.00	22.62	C
ATOM	2165	N	THR	A	285	94.341	61.914	35.004	1.00	25.00	N
ATOM	2166	CA	THR	A	285	93.936	62.015	36.403	1.00	25.00	C
ATOM	2167	C	THR	A	285	95.149	62.180	37.308	1.00	24.68	C
ATOM	2168	O	THR	A	285	96.282	61.956	36.889	1.00	22.17	O
ATOM	2169	CB	THR	A	285	93.176	60.759	36.851	1.00	24.60	C
ATOM	2170	OG1	THR	A	285	94.056	59.636	36.784	1.00	27.11	O
ATOM	2171	CG2	THR	A	285	91.975	60.501	35.953	1.00	23.14	C
ATOM	2172	N	ALA	A	286	94.893	62.576	38.555	1.00	25.97	N
ATOM	2173	CA	ALA	A	286	95.951	62.766	39.536	1.00	26.48	C
ATOM	2174	C	ALA	A	286	96.580	61.422	39.897	1.00	28.07	C
ATOM	2175	O	ALA	A	286	97.800	61.329	40.057	1.00	29.78	O
ATOM	2176	CB	ALA	A	286	95.395	63.445	40.783	1.00	24.43	C

-continued

ATOM	2177	N	GLU	A	287	95.763	60.378	40.022	1.00	29.47	N
ATOM	2178	CA	GLU	A	287	96.295	59.058	40.354	1.00	30.99	C
ATOM	2179	C	GLU	A	287	97.131	58.451	39.242	1.00	29.83	C
ATOM	2180	O	GLU	A	287	98.109	57.744	39.505	1.00	29.81	O
ATOM	2181	CB	GLU	A	287	95.173	58.094	40.739	1.00	33.93	C
ATOM	2182	CG	GLU	A	287	95.052	57.909	42.255	1.00	41.21	C
ATOM	2183	CD	GLU	A	287	96.298	57.259	42.899	1.00	44.34	C
ATOM	2184	OE1	GLU	A	287	96.319	57.141	44.147	1.00	45.00	O
ATOM	2185	OE2	GLU	A	287	97.244	56.861	42.165	1.00	44.45	O
ATOM	2186	N	GLY	A	288	96.746	58.726	38.000	1.00	28.61	N
ATOM	2187	CA	GLY	A	288	97.495	58.204	36.876	1.00	26.94	C
ATOM	2188	C	GLY	A	288	98.879	58.818	36.848	1.00	26.38	C
ATOM	2189	O	GLY	A	288	99.849	58.139	36.556	1.00	26.76	O
ATOM	2190	N	ALA	A	289	98.974	60.109	37.150	1.00	26.64	N
ATOM	2191	CA	ALA	A	289	100.257	60.793	37.156	1.00	27.29	C
ATOM	2192	C	ALA	A	289	101.087	60.229	38.296	1.00	29.11	C
ATOM	2193	O	ALA	A	289	102.293	60.013	38.159	1.00	30.09	O
ATOM	2194	CB	ALA	A	289	100.052	62.277	37.348	1.00	27.03	C
ATOM	2195	N	ARG	A	290	100.428	59.983	39.423	1.00	29.67	N
ATOM	2196	CA	ARG	A	290	101.091	59.433	40.600	1.00	30.07	C
ATOM	2197	C	ARG	A	290	101.598	58.009	40.327	1.00	29.70	C
ATOM	2198	O	ARG	A	290	102.729	57.656	40.687	1.00	30.10	O
ATOM	2199	CB	ARG	A	290	100.123	59.463	41.783	1.00	29.78	C
ATOM	2200	CG	ARG	A	290	100.653	58.884	43.073	1.00	31.76	C
ATOM	2201	CD	ARG	A	290	99.694	59.214	44.205	1.00	34.18	C
ATOM	2202	NE	ARG	A	290	99.812	60.610	44.623	1.00	37.25	N
ATOM	2203	CZ	ARG	A	290	98.786	61.440	44.789	1.00	38.76	C
ATOM	2204	NH1	ARG	A	290	97.544	61.019	44.567	1.00	41.18	N
ATOM	2205	NH2	ARG	A	290	99.001	62.685	45.195	1.00	38.72	N
ATOM	2206	N	ALA	A	291	100.774	57.194	39.673	1.00	28.72	N
ATOM	2207	CA	ALA	A	291	101.176	55.829	39.356	1.00	26.94	C
ATOM	2208	C	ALA	A	291	102.425	55.850	38.476	1.00	26.66	C
ATOM	2209	O	ALA	A	291	103.363	55.092	38.700	1.00	27.57	O
ATOM	2210	CB	ALA	A	291	100.041	55.096	38.649	1.00	24.83	C
ATOM	2211	N	LEU	A	292	102.437	56.723	37.473	1.00	26.41	N
ATOM	2212	CA	LEU	A	292	103.579	56.823	36.570	1.00	26.25	C
ATOM	2213	C	LEU	A	292	104.823	57.369	37.272	1.00	26.35	C
ATOM	2214	O	LEU	A	292	105.927	56.861	37.069	1.00	25.85	O
ATOM	2215	CB	LEU	A	292	103.221	57.688	35.356	1.00	25.03	C
ATOM	2216	CG	LEU	A	292	102.247	57.053	34.351	1.00	24.67	C
ATOM	2217	CD1	LEU	A	292	101.748	58.098	33.353	1.00	24.62	C
ATOM	2218	CD2	LEU	A	292	102.943	55.909	33.634	1.00	21.45	C
ATOM	2219	N	TYR	A	293	104.661	58.408	38.083	1.00	27.07	N
ATOM	2220	CA	TYR	A	293	105.809	58.947	38.804	1.00	28.43	C
ATOM	2221	C	TYR	A	293	106.353	57.853	39.710	1.00	29.43	C
ATOM	2222	O	TYR	A	293	107.555	57.601	39.738	1.00	29.87	O
ATOM	2223	CB	TYR	A	293	105.398	60.155	39.629	1.00	28.36	C
ATOM	2224	CG	TYR	A	293	105.192	61.411	38.812	1.00	29.78	C
ATOM	2225	CD1	TYR	A	293	104.175	62.310	39.134	1.00	29.30	C
ATOM	2226	CD2	TYR	A	293	106.038	61.725	37.744	1.00	29.08	C
ATOM	2227	CE1	TYR	A	293	104.000	63.485	38.417	1.00	28.70	C
ATOM	2228	CE2	TYR	A	293	105.868	62.905	37.020	1.00	28.90	C
ATOM	2229	CZ	TYR	A	293	104.844	63.776	37.367	1.00	28.75	C
ATOM	2230	OH	TYR	A	293	104.644	64.936	36.666	1.00	29.75	O
ATOM	2231	N	ASP	A	294	105.456	57.191	40.435	1.00	30.73	N
ATOM	2232	CA	ASP	A	294	105.846	56.104	41.325	1.00	32.03	C
ATOM	2233	C	ASP	A	294	106.533	54.961	40.573	1.00	33.10	C
ATOM	2234	O	ASP	A	294	107.287	54.185	41.167	1.00	34.97	O
ATOM	2235	CB	ASP	A	294	104.623	55.570	42.067	1.00	31.61	C
ATOM	2236	CG	ASP	A	294	104.081	56.554	43.080	1.00	32.26	C
ATOM	2237	OD1	ASP	A	294	103.034	56.266	43.700	1.00	33.58	O
ATOM	2238	OD2	ASP	A	294	104.704	57.615	43.267	1.00	32.44	O
ATOM	2239	N	ALA	A	295	106.275	54.854	39.271	1.00	32.83	N
ATOM	2240	CA	ALA	A	295	106.879	53.802	38.455	1.00	31.74	C
ATOM	2241	C	ALA	A	295	108.264	54.224	37.992	1.00	31.68	C
ATOM	2242	O	ALA	A	295	108.985	53.436	37.380	1.00	32.56	O
ATOM	2243	CB	ALA	A	295	105.997	53.482	37.251	1.00	30.93	C
ATOM	2244	N	GLY	A	296	108.630	55.470	38.269	1.00	30.95	N
ATOM	2245	CA	GLY	A	296	109.948	55.933	37.882	1.00	31.13	C
ATOM	2246	C	GLY	A	296	110.045	56.900	36.717	1.00	31.66	C
ATOM	2247	O	GLY	A	296	111.149	57.204	36.265	1.00	31.91	O
ATOM	2248	N	VAL	A	297	108.919	57.394	36.219	1.00	31.67	N
ATOM	2249	CA	VAL	A	297	108.978	58.328	35.101	1.00	31.83	C
ATOM	2250	C	VAL	A	297	109.416	59.716	35.586	1.00	29.98	C
ATOM	2251	O	VAL	A	297	109.171	60.092	36.730	1.00	29.21	O
ATOM	2252	CB	VAL	A	297	107.606	58.445	34.382	1.00	32.91	C
ATOM	2253	CG1	VAL	A	297	106.596	59.096	35.290	1.00	35.68	C
ATOM	2254	CG2	VAL	A	297	107.747	59.266	33.125	1.00	35.70	C
ATOM	2255	N	ASP	A	298	110.074	60.463	34.707	1.00	28.22	N

-continued

ATOM	2256	CA	ASP	A	298	110.545	61.801	35.022	1.00	27.00	C
ATOM	2257	C	ASP	A	298	109.528	62.852	34.607	1.00	27.20	C
ATOM	2258	O	ASP	A	298	109.281	63.813	35.332	1.00	26.86	O
ATOM	2259	CB	ASP	A	298	111.870	62.071	34.309	1.00	28.58	C
ATOM	2260	CG	ASP	A	298	112.974	61.149	34.776	1.00	30.31	C
ATOM	2261	OD1	ASP	A	298	113.221	61.114	35.994	1.00	34.37	O
ATOM	2262	OD2	ASP	A	298	113.600	60.462	33.943	1.00	31.52	O
ATOM	2263	N	VAL	A	299	108.942	62.664	33.430	1.00	26.94	N
ATOM	2264	CA	VAL	A	299	107.955	63.596	32.898	1.00	25.40	C
ATOM	2265	C	VAL	A	299	106.704	62.825	32.462	1.00	24.71	C
ATOM	2266	O	VAL	A	299	106.792	61.831	31.736	1.00	24.19	O
ATOM	2267	CB	VAL	A	299	108.526	64.371	31.667	1.00	25.18	C
ATOM	2268	CG1	VAL	A	299	107.573	65.493	31.255	1.00	23.30	C
ATOM	2269	CG2	VAL	A	299	109.908	64.920	31.985	1.00	24.81	C
ATOM	2270	N	VAL	A	300	105.544	63.287	32.916	1.00	23.99	N
ATOM	2271	CA	VAL	A	300	104.270	62.661	32.576	1.00	23.71	C
ATOM	2272	C	VAL	A	300	103.499	63.493	31.555	1.00	24.32	C
ATOM	2273	O	VAL	A	300	103.338	64.707	31.730	1.00	24.20	O
ATOM	2274	CB	VAL	A	300	103.370	62.486	33.825	1.00	23.42	C
ATOM	2275	CG1	VAL	A	300	101.967	62.116	33.407	1.00	23.29	C
ATOM	2276	CG2	VAL	A	300	103.923	61.391	34.722	1.00	23.23	C
ATOM	2277	N	LYS	A	301	103.033	62.854	30.484	1.00	24.40	N
ATOM	2278	CA	LYS	A	301	102.258	63.588	29.503	1.00	24.04	C
ATOM	2279	C	LYS	A	301	100.782	63.356	29.753	1.00	22.78	C
ATOM	2280	O	LYS	A	301	100.322	62.229	29.960	1.00	21.52	O
ATOM	2281	CB	LYS	A	301	102.686	63.259	28.065	1.00	24.29	C
ATOM	2282	CG	LYS	A	301	102.809	61.818	27.709	1.00	29.51	C
ATOM	2283	CD	LYS	A	301	103.757	61.674	26.489	1.00	32.99	C
ATOM	2284	CE	LYS	A	301	103.228	62.284	25.187	1.00	30.67	C
ATOM	2285	NZ	LYS	A	301	102.178	61.439	24.564	1.00	30.01	N
ATOM	2286	N	VAL	A	302	100.060	64.470	29.782	1.00	22.18	N
ATOM	2287	CA	VAL	A	302	98.641	64.485	30.061	1.00	22.10	C
ATOM	2289	C	VAL	A	302	97.793	64.628	28.807	1.00	22.59	C
ATOM	2289	O	VAL	A	302	98.082	65.457	27.938	1.00	22.52	O
ATOM	2290	CB	VAL	A	302	98.306	65.652	31.032	1.00	21.25	C
ATOM	2291	CG1	VAL	A	302	96.815	65.677	31.335	1.00	20.58	C
ATOM	2292	CG2	VAL	A	302	99.103	65.504	32.312	1.00	20.42	C
ATOM	2293	N	GLY	A	303	96.745	63.812	28.722	1.00	22.97	N
ATOM	2294	CA	GLY	A	303	95.854	63.892	27.582	1.00	22.25	C
ATOM	2295	C	GLY	A	303	95.160	62.618	27.153	1.00	22.34	C
ATOM	2296	O	GLY	A	303	95.784	61.750	26.566	1.00	23.71	O
ATOM	2297	N	ILE	A	304	93.873	62.493	27.453	1.00	22.67	N
ATOM	2298	CA	ILE	A	304	93.107	61.329	27.011	1.00	24.68	C
ATOM	2299	C	ILE	A	304	91.883	61.799	26.202	1.00	26.38	C
ATOM	2300	O	ILE	A	304	90.881	62.237	26.770	1.00	26.11	O
ATOM	2301	CB	ILE	A	304	92.625	60.446	28.195	1.00	23.24	C
ATOM	2302	CG1	ILE	A	304	93.818	59.799	28.906	1.00	22.41	C
ATOM	2303	CG2	ILE	A	304	91.711	59.346	27.680	1.00	21.36	C
ATOM	2304	CD1	ILE	A	304	94.503	56.718	28.113	1.00	22.43	C
ATOM	2305	N	GLY	A	305	91.996	61.747	24.872	1.00	28.56	N
ATOM	2306	CA	GLY	A	305	90.895	62.138	24.011	1.00	30.63	C
ATOM	2307	C	GLY	A	305	90.843	63.516	23.356	1.00	33.34	C
ATOM	2308	O	GLY	A	305	90.112	63.666	22.370	1.00	34.88	O
ATOM	2309	N	PRO	A	306	91.588	64.534	23.836	1.00	33.14	N
ATOM	2310	CA	PRO	A	306	91.541	65.875	23.226	1.00	33.01	C
ATOM	2311	C	PRO	A	306	92.126	66.054	21.814	1.00	33.06	C
ATOM	2312	O	PRO	A	306	91.928	67.104	21.191	1.00	33.29	O
ATOM	2313	CB	PRO	A	306	92.275	66.728	24.256	1.00	30.93	C
ATOM	2314	CG	PRO	A	306	93.353	65.772	24.704	1.00	30.96	C
ATOM	2315	CD	PRO	A	306	92.504	64.547	24.992	1.00	31.97	C
ATOM	2316	N	GLY	A	307	92.833	65.044	21.313	1.00	33.26	N
ATOM	2317	CA	GLY	A	307	93.446	65.148	19.994	1.00	33.13	C
ATOM	2318	C	GLY	A	307	92.525	65.502	18.837	1.00	33.48	C
ATOM	2319	O	GLY	A	307	91.414	64.982	16.739	1.00	33.64	O
ATOM	2320	N	SER	A	308	92.992	66.382	17.950	1.00	32.89	N
ATOM	2321	CA	SER	A	308	92.209	66.802	16.783	1.00	33.08	C
ATOM	2322	C	SER	A	308	91.745	65.606	15.950	1.00	32.80	C
ATOM	2323	O	SER	A	308	90.623	65.577	15.452	1.00	33.12	O
ATOM	2324	CB	SER	A	308	93.038	67.743	15.898	1.00	32.26	C
ATOM	2325	OG	SER	A	308	94.229	67.114	15.448	1.00	31.53	O
ATOM	2326	N	ILE	A	309	92.625	64.625	15.809	1.00	33.27	N
ATOM	2327	CA	ILE	A	309	92.346	63.416	15.045	1.00	34.38	C
ATOM	2328	C	ILE	A	309	91.953	62.229	15.940	1.00	34.76	C
ATOM	2329	O	ILE	A	309	91.843	61.095	15.471	1.00	34.40	O
ATOM	2330	CB	ILE	A	309	93.590	63.033	14.176	1.00	35.31	C
ATOM	2331	CG1	ILE	A	309	94.878	63.132	15.004	1.00	35.26	C
ATOM	2332	CG2	ILE	A	309	93.709	63.974	12.980	1.00	34.04	C
ATOM	2333	CD1	ILE	A	309	94.957	62.199	16.191	1.00	36.80	C
ATOM	2334	N	CYS	A	310	91.743	62.506	17.227	1.00	35.32	N

-continued

ATOM	2335	CA	CYS	A	310	91.380	61.483	18.209	1.00	35.11	C
ATOM	2336	C	CYS	A	310	89.882	61.214	18.337	1.00	34.44	C
ATOM	2337	O	CYS	A	310	89.072	62.142	18.449	1.00	33.70	O
ATOM	2338	CB	CYS	A	310	91.922	61.873	19.587	1.00	36.64	C
ATOM	2339	SG	CYS	A	310	91.351	60.810	20.950	1.00	40.34	S
ATOM	2340	N	THR	A	311	89.529	59.931	18.351	1.00	33.48	N
ATOM	2341	CA	THR	A	311	88.143	59.500	18.487	1.00	33.03	C
ATOM	2342	C	THR	A	311	87.936	58.662	19.756	1.00	31.85	C
ATOM	2343	O	THR	A	311	86.911	58.016	19.924	1.00	32.55	O
ATOM	2344	CB	THR	A	311	87.720	58.657	17.287	1.00	34.00	C
ATOM	2345	OG1	THR	A	311	88.594	57.526	17.180	1.00	36.60	O
ATOM	2346	CG2	THR	A	311	87.797	59.474	16.004	1.00	34.76	C
ATOM	2347	N	THR	A	312	88.912	58.667	20.650	1.00	30.55	N
ATOM	2348	CA	THR	A	312	88.794	57.905	21.884	1.00	29.18	C
ATOM	2349	C	THR	A	312	87.523	58.238	22.661	1.00	28.00	C
ATOM	2350	O	THR	A	312	86.831	57.344	23.144	1.00	27.47	O
ATOM	2351	CB	THR	A	312	90.018	58.142	22.783	1.00	29.25	C
ATOM	2352	OG1	THR	A	312	91.174	57.572	22.159	1.00	31.01	O
ATOM	2353	CG2	THR	A	312	89.821	57.509	24.150	1.00	30.17	C
ATOM	2354	N	ARG	A	313	87.199	59.518	22.774	1.00	26.42	N
ATOM	2355	CA	ARG	A	313	86.015	59.899	23.519	1.00	26.82	C
ATOM	2356	C	ARG	A	313	84.712	59.469	22.858	1.00	27.41	C
ATOM	2357	O	ARG	A	313	83.699	59.237	23.531	1.00	28.22	O
ATOM	2358	CB	ARG	A	313	86.025	61.407	23.765	1.00	27.23	C
ATOM	2359	CG	ARG	A	313	87.207	61.837	24.616	1.00	28.90	C
ATOM	2360	CD	ARG	A	313	87.183	63.318	24.904	1.00	31.11	C
ATOM	2361	NE	ARG	A	313	88.414	63.773	25.552	1.00	32.48	N
ATOM	2362	CZ	ARG	A	313	88.674	65.046	25.840	1.00	32.07	C
ATOM	2363	NH1	ARG	A	313	87.790	65.996	25.540	1.00	30.54	N
ATOM	2364	NH2	ARG	A	313	89.817	65.366	26.430	1.00	31.87	N
ATOM	2365	N	VAL	A	314	84.746	59.339	21.540	1.00	26.45	N
ATOM	2366	CA	VAL	A	314	83.576	58.952	20.774	1.00	25.00	C
ATOM	2367	C	VAL	A	314	83.364	57.446	20.698	1.00	24.59	C
ATOM	2368	O	VAL	A	314	82.253	56.963	20.890	1.00	24.29	O
ATOM	2369	CB	VAL	A	314	83.672	59.496	19.338	1.00	26.31	C
ATOM	2370	CG1	VAL	A	314	82.429	59.127	18.558	1.00	26.03	C
ATOM	2371	CG2	VAL	A	314	83.866	60.998	19.371	1.00	25.74	C
ATOM	2372	N	VAL	A	315	84.428	56.704	20.416	1.00	24.12	N
ATOM	2373	CA	VAL	A	315	84.322	55.255	20.286	1.00	24.14	C
ATOM	2374	C	VAL	A	315	84.419	54.460	21.595	1.00	23.17	C
ATOM	2375	O	VAL	A	315	83.837	53.387	21.713	1.00	22.34	O
ATOM	2376	CB	VAL	A	315	85.351	54.737	19.266	1.00	23.99	C
ATOM	2377	CG1	VAL	A	315	85.058	55.352	17.897	1.00	24.71	C
ATOM	2378	CG2	VAL	A	315	86.754	55.099	19.705	1.00	25.41	C
ATOM	2379	N	ALA	A	316	85.137	54.992	22.577	1.00	22.80	N
ATOM	2380	CA	ALA	A	316	85.273	54.322	23.864	1.00	22.89	C
ATOM	2381	C	ALA	A	316	84.453	55.075	24.907	1.00	23.76	C
ATOM	2382	O	ALA	A	316	84.096	54.525	25.955	1.00	23.93	O
ATOM	2383	CB	ALA	A	316	86.739	54.277	24.278	1.00	21.84	C
ATOM	2384	N	GLY	A	317	84.154	56.337	24.607	1.00	24.54	N
ATOM	2385	CA	GLY	A	317	83.378	57.167	25.511	1.00	24.66	C
ATOM	2386	C	GLY	A	317	84.154	57.582	26.744	1.00	25.96	C
ATOM	2387	O	GLY	A	317	83.558	57.954	27.759	1.00	26.42	O
ATOM	2388	N	VAL	A	318	85.482	57.545	26.646	1.00	25.51	N
ATOM	2389	CA	VAL	A	318	86.369	57.879	27.760	1.00	24.79	C
ATOM	2390	C	VAL	A	318	87.219	59.133	27.554	1.00	25.38	C
ATOM	2391	O	VAL	A	318	87.633	59.437	26.438	1.00	25.50	O
ATOM	2392	CB	VAL	A	318	87.317	56.693	28.049	1.00	24.92	C
ATOM	2393	CG1	VAL	A	318	88.363	57.081	29.090	1.00	24.67	C
ATOM	2394	CG2	VAL	A	318	86.507	55.500	28.535	1.00	23.44	C
ATOM	2395	N	GLY	A	319	87.477	59.851	28.645	1.00	24.73	N
ATOM	2396	CA	GLY	A	319	88.304	61.043	28.578	1.00	25.39	C
ATOM	2397	C	GLY	A	319	87.980	62.097	29.620	1.00	25.66	C
ATOM	2398	O	GLY	A	319	87.076	61.926	30.437	1.00	25.40	O
ATOM	2399	N	VAL	A	320	88.737	63.188	29.609	1.00	24.72	N
ATOM	2400	CA	VAL	A	320	88.484	64.281	30.535	1.00	25.55	C
ATOM	2401	C	VAL	A	320	88.944	65.581	29.903	1.00	23.92	C
ATOM	2402	O	VAL	A	320	90.033	65.653	29.331	1.00	22.93	O
ATOM	2403	CB	VAL	A	320	89.203	64.087	31.899	1.00	27.29	C
ATOM	2404	CG1	VAL	A	320	90.667	64.017	31.693	1.00	32.20	C
ATOM	2405	CG2	VAL	A	320	88.884	65.241	32.838	1.00	26.56	C
ATOM	2406	N	PRO	A	321	88.100	66.625	29.980	1.00	23.64	N
ATOM	2407	CA	PRO	A	321	88.438	67.928	29.408	1.00	22.67	C
ATOM	2408	C	PRO	A	321	89.872	68.279	29.791	1.00	22.52	C
ATOM	2409	O	PRO	A	321	90.232	68.263	30.961	1.00	23.18	O
ATOM	2410	CB	PRO	A	321	87.381	68.823	30.028	1.00	23.67	C
ATOM	2411	CG	PRO	A	321	86.164	67.896	29.986	1.00	20.93	C
ATOM	2412	CD	PRO	A	321	86.780	66.686	30.640	1.00	22.53	C
ATOM	2413	N	GLN	A	322	90.679	68.588	28.786	1.00	22.16	N

-continued

ATOM	2414	CA	GLN	A	322	92.099	68.880	28.948	1.00	21.62	C
ATOM	2415	C	GLN	A	322	92.573	69.884	30.002	1.00	20.84	C
ATOM	2416	O	GLN	A	322	93.551	69.609	30.679	1.00	21.63	O
ATOM	2417	CB	GLN	A	322	92.684	69.245	27.578	1.00	22.97	C
ATOM	2418	CG	GLN	A	322	94.217	69.292	27.491	1.00	24.38	C
ATOM	2419	CD	GLN	A	322	94.896	67.951	27.725	1.00	23.75	C
ATOM	2420	OE1	GLN	A	322	96.067	67.776	27.390	1.00	26.82	O
ATOM	2421	NE2	GLN	A	322	94.176	67.011	28.314	1.00	23.57	N
ATOM	2422	N	VAL	A	323	91.932	71.037	30.151	1.00	19.60	N
ATOM	2423	CA	VAL	A	323	92.401	71.970	31.175	1.00	19.52	C
ATOM	2424	C	VAL	A	323	92.280	71.357	32.572	1.00	20.46	C
ATOM	2425	O	VAL	A	323	93.144	71.556	33.420	1.00	22.03	O
ATOM	2426	CB	VAL	A	323	91.645	73.322	31.143	1.00	17.80	C
ATOM	2427	CG1	VAL	A	323	92.026	74.177	32.359	1.00	17.57	C
ATOM	2428	CG2	VAL	A	323	92.009	74.070	29.888	1.00	18.00	C
ATOM	2429	N	THR	A	324	91.210	70.616	32.815	1.00	21.51	N
ATOM	2430	CA	THR	A	324	91.029	69.961	34.106	1.00	21.74	C
ATOM	2431	C	THR	A	324	92.056	68.845	34.307	1.00	22.09	C
ATOM	2432	O	THR	A	324	92.628	68.704	35.393	1.00	22.04	O
ATOM	2433	CB	THR	A	324	89.616	69.383	34.221	1.00	21.42	C
ATOM	2434	OG1	THR	A	324	88.696	70.448	34.469	1.00	23.37	O
ATOM	2435	CG2	THR	A	324	89.532	68.370	35.335	1.00	24.31	C
ATOM	2436	N	ALA	A	325	92.296	68.062	33.256	1.00	21.63	N
ATOM	2437	CA	ALA	A	325	93.253	66.958	33.324	1.00	23.09	C
ATOM	2438	C	ALA	A	325	94.669	67.437	33.668	1.00	23.65	C
ATOM	2439	O	ALA	A	325	95.325	66.865	34.540	1.00	23.99	O
ATOM	2440	CB	ALA	A	325	93.262	66.192	32.006	1.00	22.44	C
ATOM	2441	N	ILE	A	326	95.134	68.472	32.967	1.00	23.50	N
ATOM	2442	CA	ILE	A	326	96.458	69.067	33.182	1.00	23.40	C
ATOM	2443	C	ILE	A	326	96.576	69.483	34.641	1.00	24.71	C
ATOM	2444	O	ILE	A	326	97.520	69.124	35.337	1.00	24.66	O
ATOM	2445	CB	ILE	A	326	96.644	70.329	32.295	1.00	22.70	C
ATOM	2446	CG1	ILE	A	326	96.680	69.913	30.821	1.00	22.18	C
ATOM	2447	CG2	ILE	A	326	97.900	71.096	32.699	1.00	20.32	C
ATOM	2448	CD1	ILE	A	326	96.689	71.078	29.861	1.00	22.52	C
ATOM	2449	N	TYR	A	327	95.589	70.244	35.082	1.00	25.51	N
ATOM	2450	CA	TYR	A	327	95.512	70.739	36.439	1.00	27.53	C
ATOM	2451	C	TYR	A	327	95.493	69.644	37.506	1.00	26.67	C
ATOM	2452	O	TYR	A	327	96.234	69.706	38.470	1.00	26.34	O
ATOM	2453	CB	TYR	A	327	94.278	71.615	36.527	1.00	31.94	C
ATOM	2454	CG	TYR	A	327	93.867	72.043	37.900	1.00	36.64	C
ATOM	2455	CD1	TYR	A	327	93.354	71.127	38.812	1.00	40.23	C
ATOM	2456	CD2	TYR	A	327	93.868	73.375	38.243	1.00	38.78	C
ATOM	2457	CE1	TYR	A	327	92.839	71.536	40.027	1.00	42.47	C
ATOM	2458	CE2	TYR	A	327	93.358	73.790	39.431	1.00	42.01	C
ATOM	2459	CZ	TYR	A	327	92.838	72.873	40.329	1.00	43.22	C
ATOM	2460	OH	TYR	A	327	92.305	73.316	41.524	1.00	47.71	O
ATOM	2461	N	ASP	A	328	94.635	68.650	37.347	1.00	27.41	N
ATOM	2462	CA	ASP	A	328	94.573	67.559	38.312	1.00	28.23	C
ATOM	2463	C	ASP	A	328	95.910	66.825	38.383	1.00	28.97	C
ATOM	2464	O	ASP	A	328	96.342	66.414	39.455	1.00	30.49	O
ATOM	2465	CB	ASP	A	328	93.469	66.570	37.925	1.00	28.63	C
ATOM	2466	CG	ASP	A	328	92.074	67.171	38.042	1.00	29.55	C
ATOM	2467	OD1	ASP	A	328	91.096	66.496	37.643	1.00	28.91	O
ATOM	2468	OD2	ASP	A	328	91.954	68.312	38.541	1.00	30.66	O
ATOM	2469	N	ALA	A	329	96.568	66.666	37.237	1.00	28.70	N
ATOM	2470	CA	ALA	A	329	97.848	65.969	37.185	1.00	27.96	C
ATOM	2471	C	ALA	A	329	98.993	66.816	37.713	1.00	27.90	C
ATOM	2472	O	ALA	A	329	99.898	66.303	38.368	1.00	27.58	O
ATOM	2473	CB	ALA	A	329	98.150	65.534	35.755	1.00	28.88	C
ATOM	2474	N	ALA	A	330	98.950	68.112	37.417	1.00	27.54	N
ATOM	2475	CA	ALA	A	330	99.993	69.041	37.839	1.00	27.36	C
ATOM	2476	C	ALA	A	330	100.035	69.195	39.352	1.00	27.62	C
ATOM	2477	O	ALA	A	330	101.039	69.631	39.909	1.00	27.21	O
ATOM	2478	CB	ALA	A	330	99.784	70.397	37.175	1.00	26.61	C
ATOM	2479	N	ALA	A	331	98.941	68.841	40.016	1.00	28.38	N
ATOM	2480	CA	ALA	A	331	98.882	68.923	41.467	1.00	29.60	C
ATOM	2481	C	ALA	A	331	99.870	67.902	42.005	1.00	30.94	C
ATOM	2482	O	ALA	A	331	100.556	68.144	42.995	1.00	31.96	O
ATOM	2483	CB	ALA	A	331	97.489	68.601	41.955	1.00	29.46	C
ATOM	2484	N	VAL	A	332	99.941	66.756	41.334	1.00	31.86	N
ATOM	2485	CA	VAL	A	332	100.851	65.683	41.723	1.00	31.71	C
ATOM	2486	C	VAL	A	332	102.276	65.984	41.267	1.00	32.27	C
ATOM	2487	O	VAL	A	332	103.231	65.700	41.981	1.00	32.86	O
ATOM	2488	CB	VAL	A	332	100.408	64.328	41.122	1.00	30.47	C
ATOM	2489	CG1	VAL	A	332	101.394	63.229	41.512	1.00	29.17	C
ATOM	2490	CG2	VAL	A	332	99.009	63.989	41.602	1.00	29.70	C
ATOM	2491	N	ALA	A	333	102.412	66.561	40.078	1.00	32.53	N
ATOM	2492	CA	ALA	A	333	103.723	66.889	39.543	1.00	33.43	C

-continued

ATOM	2493	C	ALA	A	333	104.469	67.763	40.528	1.00	35.24	C
ATOM	2494	O	ALA	A	333	105.677	67.623	40.701	1.00	35.30	O
ATOM	2495	CB	ALA	A	333	103.587	67.607	38.218	1.00	32.68	C
ATOM	2496	N	ARG	A	334	103.757	68.675	41.178	1.00	36.59	N
ATOM	2497	CA	ARG	A	334	104.422	69.544	42.136	1.00	38.67	C
ATOM	2498	C	ARG	A	334	104.682	68.857	43.458	1.00	38.64	C
ATOM	2499	O	ARG	A	334	105.646	69.181	44.140	1.00	39.25	O
ATOM	2500	CB	ARG	A	334	103.650	70.853	42.343	1.00	39.27	C
ATOM	2501	CG	ARG	A	334	102.152	70.742	42.460	1.00	41.57	C
ATOM	2502	CD	ARG	A	334	101.611	72.112	42.821	1.00	42.79	C
ATOM	2503	NE	ARG	A	334	102.174	73.143	41.953	1.00	41.68	N
ATOM	2504	CZ	ARG	A	334	102.177	74.441	42.245	1.00	41.25	C
ATOM	2505	NH1	ARG	A	334	101.648	74.876	43.384	1.00	39.55	N
ATOM	2506	NH2	ARG	A	334	102.728	75.304	41.405	1.00	40.34	N
ATOM	2507	N	GLU	A	335	103.833	67.902	43.814	1.00	38.96	N
ATOM	2508	CA	GLU	A	335	104.029	67.158	45.046	1.00	39.04	C
ATOM	2509	C	GLU	A	335	105.352	66.414	44.911	1.00	37.56	C
ATOM	2510	O	GLU	A	335	106.158	66.383	45.836	1.00	39.04	O
ATOM	2511	CB	GLU	A	335	102.895	66.157	45.258	1.00	40.81	C
ATOM	2512	CG	GLU	A	335	103.154	65.182	46.393	1.00	45.59	C
ATOM	2513	CD	GLU	A	335	102.064	64.136	46.538	1.00	48.65	C
ATOM	2514	OE1	GLU	A	335	102.219	63.227	47.383	1.00	49.61	O
ATOM	2515	OE2	GLU	A	335	101.048	64.224	45.812	1.00	51.22	O
ATOM	2516	N	TYR	A	336	105.571	65.828	43.741	1.00	35.56	N
ATOM	2517	CA	TYR	A	336	106.786	65.075	43.458	1.00	33.65	C
ATOM	2518	C	TYR	A	336	107.915	65.956	42.950	1.00	32.06	C
ATOM	2519	O	TYR	A	336	109.037	65.493	42.753	1.00	31.27	O
ATOM	2520	CB	TYR	A	336	106.508	63.979	42.418	1.00	34.56	C
ATOM	2521	CG	TYR	A	336	105.700	62.806	42.928	1.00	35.16	C
ATOM	2522	CD1	TYR	A	336	106.183	61.504	42.802	1.00	35.01	C
ATOM	2523	CD2	TYR	A	336	104.465	62.992	43.544	1.00	35.65	C
ATOM	2524	CE1	TYR	A	336	105.460	60.418	43.278	1.00	35.67	C
ATOM	2525	CE2	TYR	A	336	103.730	61.910	44.025	1.00	36.28	C
ATOM	2526	CZ	TYR	A	336	104.234	60.624	43.890	1.00	35.77	C
ATOM	2527	OH	TYR	A	336	103.516	59.548	44.372	1.00	36.21	O
ATOM	2528	N	GLY	A	337	107.619	67.230	42.738	1.00	31.22	N
ATOM	2529	CA	GLY	A	337	108.635	68.122	42.229	1.00	29.58	C
ATOM	2530	C	GLY	A	337	109.068	67.679	40.847	1.00	29.59	C
ATOM	2531	O	GLY	A	337	110.232	67.802	40.488	1.00	30.15	O
ATOM	2532	N	LYS	A	338	108.128	67.142	40.073	1.00	29.98	N
ATOM	2533	CA	LYS	A	338	108.413	66.698	38.713	1.00	29.30	C
ATOM	2534	C	LYS	A	338	107.596	67.477	37.683	1.00	28.77	C
ATOM	2535	O	LYS	A	338	106.830	68.377	38.040	1.00	27.37	O
ATOM	2536	CB	LYS	A	338	108.180	65.191	38.585	1.00	30.27	C
ATOM	2537	CG	LYS	A	338	109.235	64.382	39.330	1.00	32.74	C
ATOM	2538	CD	LYS	A	338	109.034	62.886	39.194	1.00	36.45	C
ATOM	2539	CE	LYS	A	338	110.170	62.116	39.867	1.00	38.61	C
ATOM	2540	NZ	LYS	A	338	110.001	60.628	39.761	1.00	40.61	N
ATOM	2541	N	THR	A	339	107.749	67.131	36.407	1.00	27.82	N
ATOM	2542	CA	THR	A	339	107.056	67.863	35.356	1.00	26.32	C
ATOM	2543	C	THR	A	339	105.980	67.165	34.517	1.00	26.06	C
ATOM	2544	O	THR	A	339	105.806	65.943	34.542	1.00	25.01	O
ATOM	2545	CB	THR	A	339	108.072	68.484	34.409	1.00	26.34	C
ATOM	2546	OG1	THR	A	339	108.901	67.454	33.864	1.00	25.90	O
ATOM	2547	CG2	THR	A	339	108.934	69.484	35.155	1.00	26.42	C
ATOM	2548	N	ILE	A	340	105.267	67.988	33.757	1.00	25.60	N
ATOM	2549	CA	ILE	A	340	104.174	67.543	32.911	1.00	24.59	C
ATOM	2550	C	ILE	A	340	104.152	68.189	31.525	1.00	23.54	C
ATOM	2551	O	ILE	A	340	104.555	69.337	31.342	1.00	21.85	O
ATOM	2552	CB	ILE	A	340	102.842	67.794	33.644	1.00	25.00	C
ATOM	2553	CG1	ILE	A	340	102.598	66.631	34.599	1.00	26.20	C
ATOM	2554	CG2	ILE	A	340	101.707	68.034	32.668	1.00	25.49	C
ATOM	2555	CD1	ILE	A	340	101.382	66.774	35.436	1.00	29.56	C
ATOM	2556	N	ILE	A	341	103.695	67.414	30.548	1.00	22.21	N
ATOM	2557	CA	ILE	A	341	103.573	67.873	29.176	1.00	20.48	C
ATOM	2558	C	ILE	A	341	102.080	67.824	28.863	1.00	19.91	C
ATOM	2559	O	ILE	A	341	101.439	66.793	29.068	1.00	18.38	O
ATOM	2560	CB	ILE	A	341	104.346	66.941	28.210	1.00	21.69	C
ATOM	2561	CG1	ILE	A	341	105.849	67.038	28.496	1.00	23.08	C
ATOM	2562	CG2	ILE	A	341	104.043	67.290	26.755	1.00	19.22	C
ATOM	2563	CD1	ILE	A	341	106.695	66.098	27.657	1.00	23.45	C
ATOM	2564	N	ALA	A	342	101.530	68.958	28.427	1.00	19.15	N
ATOM	2565	CA	ALA	A	342	100.121	69.060	28.046	1.00	19.91	C
ATOM	2566	C	ALA	A	342	100.064	68.553	26.601	1.00	20.89	C
ATOM	2567	O	ALA	A	342	100.556	69.205	25.680	1.00	20.43	O
ATOM	2568	CB	ALA	A	342	99.663	70.504	28.125	1.00	19.17	C
ATOM	2569	N	ASP	A	343	99.451	67.388	26.418	1.00	21.90	N
ATOM	2570	CA	ASP	A	343	99.390	66.729	25.121	1.00	22.21	C
ATOM	2571	C	ASP	A	343	98.038	66.728	24.406	1.00	23.22	C

-continued

ATOM	2572	O	ASP	A	343	97.128	66.005	24.796	1.00	23.89	O
ATOM	2573	CB	ASP	A	343	99.863	65.283	25.318	1.00	23.79	C
ATOM	2574	CG	ASP	A	343	99.944	64.499	24.028	1.00	26.58	C
ATOM	2575	OD1	ASP	A	343	100.061	63.251	24.106	1.00	25.81	O
ATOM	2576	OD2	ASP	A	343	99.911	65.122	22.941	1.00	27.87	O
ATOM	2577	N	GLY	A	344	97.917	67.541	23.359	1.00	24.09	N
ATOM	2578	CA	GLY	A	344	96.696	67.569	22.565	1.00	24.48	C
ATOM	2579	C	GLY	A	344	95.592	68.587	22.818	1.00	24.98	C
ATOM	2580	O	GLY	A	344	95.510	69.210	23.888	1.00	25.91	O
ATOM	2581	N	GLY	A	345	94.737	68.753	21.809	1.00	23.62	N
ATOM	2582	CA	GLY	A	345	93.614	69.664	21.922	1.00	22.65	C
ATOM	2583	C	GLY	A	345	93.944	71.128	21.758	1.00	22.90	C
ATOM	2584	O	GLY	A	345	93.060	71.969	21.869	1.00	23.02	O
ATOM	2585	N	ILE	A	346	95.207	71.443	21.498	1.00	22.89	N
ATOM	2586	CA	ILE	A	346	95.637	72.827	21.322	1.00	23.44	C
ATOM	2587	C	ILE	A	346	95.528	73.267	19.869	1.00	25.23	C
ATOM	2588	O	ILE	A	346	96.157	72.681	18.992	1.00	26.62	O
ATOM	2589	CB	ILE	A	346	97.090	73.005	21.774	1.00	22.40	C
ATOM	2590	CG1	ILE	A	346	97.160	72.887	23.297	1.00	23.15	C
ATOM	2591	CG2	ILE	A	346	97.631	74.327	21.268	1.00	22.29	C
ATOM	2592	CD1	ILE	A	346	98.558	72.897	23.857	1.00	25.18	C
ATOM	2593	N	LYS	A	347	94.744	74.305	19.603	1.00	25.74	N
ATOM	2594	CA	LYS	A	347	94.605	74.756	18.228	1.00	26.93	C
ATOM	2595	C	LYS	A	347	95.037	76.200	18.004	1.00	26.46	C
ATOM	2596	O	LYS	A	347	95.310	76.602	16.874	1.00	27.31	O
ATOM	2597	CB	LYS	A	347	93.169	74.501	17.744	1.00	29.47	C
ATOM	2598	CG	LYS	A	347	92.093	75.047	18.644	1.00	32.60	C
ATOM	2599	CD	LYS	A	347	90.778	74.293	18.454	1.00	36.26	C
ATOM	2600	CE	LYS	A	347	89.680	74.859	19.374	1.00	39.81	C
ATOM	2601	NZ	LYS	A	347	90.034	74.868	20.845	1.00	39.97	N
ATOM	2602	N	TYR	A	348	95.136	76.968	19.081	1.00	24.97	N
ATOM	2603	CA	TYR	A	348	95.552	78.357	18.982	1.00	24.76	C
ATOM	2604	C	TYR	A	348	96.692	78.637	19.951	1.00	25.00	C
ATOM	2605	O	TYR	A	348	96.810	77.976	20.987	1.00	24.58	O
ATOM	2606	CB	TYR	A	348	94.384	79.280	19.313	1.00	25.92	C
ATOM	2607	CG	TYR	A	348	93.224	79.180	18.362	1.00	29.00	C
ATOM	2608	CD1	TYR	A	348	93.363	79.544	17.014	1.00	31.01	C
ATOM	2609	CD2	TYR	A	348	91.975	78.759	18.806	1.00	30.18	C
ATOM	2610	CE1	TYR	A	348	92.280	79.496	16.139	1.00	31.84	C
ATOM	2611	CE2	TYR	A	348	90.886	78.706	17.940	1.00	32.70	C
ATOM	2612	CZ	TYR	A	348	91.046	79.078	16.614	1.00	33.71	C
ATOM	2613	OH	TYR	A	348	89.960	79.054	15.775	1.00	37.15	O
ATOM	2614	N	SER	A	349	97.523	79.626	19.629	1.00	23.37	N
ATOM	2615	CA	SER	A	349	98.632	79.970	20.503	1.00	23.44	C
ATOM	2616	C	SER	A	349	98.093	80.308	21.894	1.00	23.36	C
ATOM	2617	O	SER	A	349	98.747	80.049	22.900	1.00	23.98	O
ATOM	2618	CB	SER	A	349	99.432	81.151	19.936	1.00	23.65	C
ATOM	2619	OG	SER	A	349	98.657	82.331	19.874	1.00	24.07	O
ATOM	2620	N	GLY	A	350	96.896	80.880	21.950	1.00	22.72	N
ATOM	2621	CA	GLY	A	350	96.310	81.212	23.234	1.00	22.54	C
ATOM	2622	C	GLY	A	350	96.093	79.964	24.071	1.00	23.59	C
ATOM	2623	O	GLY	A	350	96.186	80.009	25.291	1.00	23.00	O
ATOM	2624	N	ASP	A	351	95.798	78.847	23.407	1.00	23.75	N
ATOM	2625	CA	ASP	A	351	95.573	77.573	24.085	1.00	23.84	C
ATOM	2626	C	ASP	A	351	96.850	77.093	24.770	1.00	23.49	C
ATOM	2627	O	ASP	A	351	96.798	76.434	25.811	1.00	22.59	O
ATOM	2628	CB	ASP	A	351	95.097	76.509	23.088	1.00	25.03	C
ATOM	2629	CG	ASP	A	351	93.660	76.720	22.638	1.00	27.18	C
ATOM	2630	OD1	ASP	A	351	93.215	76.016	21.707	1.00	28.04	O
ATOM	2631	OD2	ASP	A	351	92.966	77.576	23.226	1.00	30.15	O
ATOM	2632	N	ILE	A	352	97.994	77.421	24.178	1.00	22.40	N
ATOM	2633	CA	ILE	A	352	99.274	77.032	24.749	1.00	20.34	C
ATOM	2634	C	ILE	A	352	99.452	77.716	26.102	1.00	21.36	C
ATOM	2635	O	ILE	A	352	99.879	77.084	27.069	1.00	22.39	O
ATOM	2636	CB	ILE	A	352	100.445	77.431	23.830	1.00	18.46	C
ATOM	2637	CG1	ILE	A	352	100.296	76.753	22.474	1.00	17.19	C
ATOM	2638	CG2	ILE	A	352	101.756	77.042	24.462	1.00	17.65	C
ATOM	2639	CD1	ILE	A	352	101.395	77.086	21.512	1.00	17.04	C
ATOM	2640	N	VAL	A	353	99.122	79.005	26.172	1.00	20.35	N
ATOM	2641	CA	VAL	A	353	99.269	79.753	27.413	1.00	20.32	C
ATOM	2642	C	VAL	A	353	98.328	79.228	28.496	1.00	19.94	C
ATOM	2643	O	VAL	A	353	98.671	79.204	29.671	1.00	20.43	O
ATOM	2644	CB	VAL	A	353	98.997	81.250	27.189	1.00	21.35	C
ATOM	2645	CG1	VAL	A	353	99.315	82.026	28.455	1.00	21.91	C
ATOM	2646	CG2	VAL	A	353	99.826	81.765	26.024	1.00	22.51	C
ATOM	2647	N	LYS	A	354	97.131	78.809	28.098	1.00	21.28	N
ATOM	2648	CA	LYS	A	354	96.168	78.266	29.049	1.00	20.46	C
ATOM	2649	C	LYS	A	354	96.674	76.925	29.563	1.00	20.59	C
ATOM	2650	O	LYS	A	354	96.587	76.640	30.758	1.00	21.00	O

-continued

ATOM	2651	CB	LYS	A	354	94.797	78.067	28.388	1.00	21.23	C
ATOM	2652	CG	LYS	A	354	94.090	79.344	27.951	1.00	20.48	C
ATOM	2653	CD	LYS	A	354	92.766	79.032	27.264	1.00	19.71	C
ATOM	2654	CE	LYS	A	354	92.118	80.297	26.720	1.00	22.52	C
ATOM	2655	NZ	LYS	A	354	90.917	80.013	25.879	1.00	21.12	N
ATOM	2656	N	ALA	A	355	97.191	76.099	28.656	1.00	19.85	N
ATOM	2657	CA	ALA	A	355	97.716	74.782	29.017	1.00	20.80	C
ATOM	2658	C	ALA	A	355	98.886	74.933	29.978	1.00	21.77	C
ATOM	2659	O	ALA	A	355	99.037	74.146	30.908	1.00	22.61	O
ATOM	2660	CB	ALA	A	355	98.163	74.022	27.773	1.00	19.41	C
ATOM	2661	N	LEU	A	356	99.722	75.940	29.753	1.00	21.62	N
ATOM	2662	CA	LEU	A	356	100.858	76.168	30.630	1.00	22.27	C
ATOM	2663	C	LEU	A	356	100.367	76.727	31.957	1.00	23.40	C
ATOM	2664	O	LEU	A	356	100.846	76.342	33.015	1.00	24.73	O
ATOM	2665	CB	LEU	A	356	101.843	77.145	29.986	1.00	21.42	C
ATOM	2666	CG	LEU	A	356	102.518	76.717	28.684	1.00	20.49	C
ATOM	2667	CD1	LEU	A	356	103.328	77.875	28.141	1.00	21.00	C
ATOM	2668	CD2	LEU	A	356	103.386	75.488	28.925	1.00	21.89	C
ATOM	2669	N	ALA	A	357	99.396	77.629	31.900	1.00	23.83	N
ATOM	2670	CA	ALA	A	357	98.858	78.243	33.109	1.00	24.49	C
ATOM	2671	C	ALA	A	357	98.115	77.252	34.002	1.00	24.83	C
ATOM	2672	O	ALA	A	357	98.034	77.445	35.210	1.00	24.39	O
ATOM	2673	CB	ALA	A	357	97.943	79.396	32.739	1.00	25.49	C
ATOM	2674	N	ALA	A	358	97.577	76.191	33.412	1.00	23.94	N
ATOM	2675	CA	ALA	A	358	96.856	75.192	34.189	1.00	23.85	C
ATOM	2676	C	ALA	A	358	97.818	74.209	34.853	1.00	24.49	C
ATOM	2677	O	ALA	A	358	97.391	73.320	35.595	1.00	24.74	O
ATOM	2678	CB	ALA	A	358	95.865	74.440	33.300	1.00	24.65	C
ATOM	2679	N	GLY	A	359	99.113	74.349	34.579	1.00	24.04	N
ATOM	2680	CA	GLY	A	359	100.074	73.460	35.206	1.00	23.58	C
ATOM	2681	C	GLY	A	359	101.065	72.763	34.300	1.00	23.49	C
ATOM	2682	O	GLY	A	359	101.964	72.073	34.786	1.00	24.97	O
ATOM	2683	N	GLY	A	360	100.924	72.929	32.990	1.00	22.19	N
ATOM	2684	CA	GLY	A	360	101.847	72.279	32.083	1.00	19.65	C
ATOM	2685	C	GLY	A	360	103.209	72.936	32.105	1.00	20.75	C
ATOM	2686	O	GLY	A	360	103.312	74.134	32.324	1.00	20.45	O
ATOM	2687	N	ASN	A	361	104.258	72.148	31.887	1.00	20.92	N
ATOM	2688	CA	ASN	A	361	105.630	72.655	31.855	1.00	22.23	C
ATOM	2689	C	ASN	A	361	106.051	72.782	30.402	1.00	22.46	C
ATOM	2690	O	ASN	A	361	107.060	73.407	30.079	1.00	22.58	O
ATOM	2691	CB	ASN	A	361	106.568	71.697	32.589	1.00	22.17	C
ATOM	2692	CG	ASN	A	361	106.338	71.703	34.085	1.00	25.53	C
ATOM	2693	OD1	ASN	A	361	106.646	72.688	34.763	1.00	27.16	O
ATOM	2694	ND2	ASN	A	361	105.766	70.624	34.607	1.00	25.19	N
ATOM	2695	N	ALA	A	362	105.251	72.178	29.530	1.00	22.54	N
ATOM	2696	CA	ALA	A	362	105.481	72.193	28.095	1.00	21.37	C
ATOM	2697	C	ALA	A	362	104.229	71.625	27.432	1.00	21.05	C
ATOM	2698	O	ALA	A	362	103.423	70.969	28.084	1.00	18.71	O
ATOM	2699	CB	ALA	A	362	106.704	71.341	27.753	1.00	20.68	C
ATOM	2700	N	VAL	A	363	104.058	71.895	26.142	1.00	22.66	N
ATOM	2701	CA	VAL	A	363	102.903	71.377	25.410	1.00	22.68	C
ATOM	2702	C	VAL	A	363	103.389	70.579	24.210	1.00	22.35	C
ATOM	2703	O	VAL	A	363	104.423	70.893	23.638	1.00	23.37	O
ATOM	2704	CE	VAL	A	363	101.964	72.521	24.910	1.00	22.34	C
ATOM	2705	CG1	VAL	A	363	101.440	73.333	26.088	1.00	21.37	C
ATOM	2706	CG2	VAL	A	363	102.702	73.418	23.929	1.00	22.84	C
HETATM	2707	N	MSE	A	364	102.662	69.530	23.851	1.00	21.88	N
HETATM	2708	CA	MSE	A	364	103.027	68.726	22.692	1.00	22.51	C
HETATM	2709	C	MSE	A	364	102.014	69.063	21.608	1.00	23.49	C
HETATM	2710	O	MSE	A	364	100.794	69.022	21.832	1.00	23.44	O
HETATM	2711	CB	MSE	A	364	103.011	67.231	23.028	1.00	24.05	C
HETATM	2712	CG	MSE	A	364	103.223	66.330	21.821	1.00	27.31	C
HETATM	2713	SE	MSE	A	364	103.374	64.556	22.241	1.00	35.51	SE
HETATM	2714	CE	MSE	A	364	105.096	64.508	22.891	1.00	32.69	C
ATOM	2715	N	LEU	A	365	102.531	69.420	20.436	1.00	23.87	N
ATOM	2716	CA	LEU	A	365	101.704	69.831	19.315	1.00	24.27	C
ATOM	2717	C	LEU	A	365	101.822	68.920	18.108	1.00	25.78	C
ATOM	2718	O	LEU	A	365	102.926	68.614	17.666	1.00	26.09	O
ATOM	2719	CB	LEU	A	365	102.104	71.238	18.905	1.00	22.73	C
ATOM	2720	CG	LEU	A	365	102.093	72.219	20.060	1.00	23.17	C
ATOM	2721	CD1	LEU	A	365	102.705	73.527	19.616	1.00	24.46	C
ATOM	2722	CD2	LEU	A	365	100.670	72.378	20.574	1.00	22.59	C
ATOM	2723	N	GLY	A	366	100.678	68.508	17.569	1.00	26.69	N
ATOM	2724	CA	GLY	A	366	100.667	67.651	16.398	1.00	28.30	C
ATOM	2725	C	GLY	A	366	100.045	68.365	15.213	1.00	29.57	C
ATOM	2726	O	GLY	A	366	100.717	68.663	14.226	1.00	29.34	O
ATOM	2727	N	SER	A	367	98.753	68.644	15.327	1.00	30.92	N
ATOM	2728	CA	SER	A	367	97.993	69.341	14.298	1.00	33.00	C
ATOM	2729	C	SER	A	367	98.648	70.637	13.803	1.00	34.00	C

-continued

ATOM	2730	O	SER	A	367	98.750	70.848	12.598	1.00	33.51	O
ATOM	2731	CB	SER	A	367	96.590	69.646	14.832	1.00	34.28	C
ATOM	2732	OG	SER	A	367	95.800	70.345	13.885	1.00	34.75	O
HETATM	2733	N	MSE	A	368	99.097	71.501	14.713	1.00	34.95	N
HETATM	2734	CA	MSE	A	368	99.712	72.765	14.296	1.00	37.45	C
HETATM	2735	C	MSE	A	368	100.963	72.668	13.424	1.00	36.66	C
HETATM	2736	O	MSE	A	368	101.316	73.635	12.748	1.00	36.99	O
HETATM	2737	CB	MSE	A	368	100.000	73.664	15.506	1.00	40.56	C
HETATM	2738	CG	MSE	A	368	98.719	74.111	16.191	1.00	46.02	C
HETATM	2739	SE	MSE	A	368	98.916	75.343	17.492	1.00	56.80	SE
HETATM	2740	CE	MSE	A	368	99.964	74.527	18.572	1.00	55.31	C
ATOM	2741	N	PHE	A	369	101.626	71.513	13.417	1.00	34.82	N
ATOM	2742	CA	PHE	A	369	102.830	71.339	12.603	1.00	31.76	C
ATOM	2743	C	PHE	A	369	102.600	70.421	11.416	1.00	31.43	C
ATOM	2744	O	PHE	A	369	103.378	70.425	10.467	1.00	30.91	O
ATOM	2745	CB	PHE	A	369	103.977	70.786	13.460	1.00	29.79	C
ATOM	2746	CG	PHE	A	369	104.507	71.765	14.473	1.00	26.59	C
ATOM	2747	CD1	PHE	A	369	104.387	71.518	15.829	1.00	27.53	C
ATOM	2748	CD2	PHE	A	369	105.121	72.947	14.062	1.00	27.73	C
ATOM	2749	CE1	PHE	A	369	104.872	72.444	16.771	1.00	27.77	C
ATOM	2750	CE2	PHE	A	369	105.605	73.874	14.990	1.00	27.15	C
ATOM	2751	CZ	PHE	A	369	105.481	73.622	16.345	1.00	26.83	C
ATOM	2752	N	ALA	A	370	101.510	69.658	11.479	1.00	32.61	N
ATOM	2753	CA	ALA	A	370	101.108	68.668	10.465	1.00	33.73	C
ATOM	2754	C	ALA	A	370	101.243	68.936	8.953	1.00	34.56	C
ATOM	2755	O	ALA	A	370	101.405	67.982	8.173	1.00	35.53	O
ATOM	2756	CB	ALA	A	370	99.682	68.213	10.761	1.00	33.78	C
ATOM	2757	N	GLY	A	371	101.165	70.191	8.518	1.00	33.99	N
ATOM	2758	CA	GLY	A	371	101.282	70.453	7.090	1.00	33.01	C
ATOM	2759	C	GLY	A	371	102.500	71.252	6.666	1.00	33.01	C
ATOM	2760	O	GLY	A	371	102.537	71.811	5.564	1.00	32.73	O
ATOM	2761	N	THR	A	372	103.508	71.299	7.530	1.00	32.22	N
ATOM	2762	CA	THR	A	372	104.724	72.055	7.244	1.00	32.27	C
ATOM	2763	C	THR	A	372	105.688	71.363	6.276	1.00	33.94	C
ATOM	2764	O	THR	A	372	105.448	70.244	5.828	1.00	35.02	O
ATOM	2765	CB	THR	A	372	105.479	72.426	8.567	1.00	30.26	C
ATOM	2766	OG1	THR	A	372	105.828	71.242	9.298	1.00	27.73	O
ATOM	2767	CG2	THR	A	372	104.601	73.299	9.440	1.00	28.61	C
ATOM	2768	N	ASP	A	373	106.771	72.052	5.937	1.00	35.72	N
ATOM	2769	CA	ASP	A	373	107.775	71.506	5.040	1.00	37.55	C
ATOM	2770	C	ASP	A	373	108.346	70.234	5.665	1.00	39.10	C
ATOM	2771	O	ASP	A	373	108.423	69.187	5.023	1.00	39.87	O
ATOM	2772	CB	ASP	A	373	108.893	72.531	4.844	1.00	39.43	C
ATOM	2773	CG	ASP	A	373	108.394	73.826	4.223	1.00	42.12	C
ATOM	2774	OD1	ASP	A	373	109.121	74.847	4.253	1.00	42.31	O
ATOM	2775	CD2	ASP	A	373	107.267	73.815	3.687	1.00	45.19	O
ATOM	2776	N	GLU	A	374	108.720	70.334	6.937	1.00	39.77	N
ATOM	2777	CA	GLU	A	374	109.312	69.224	7.676	1.00	40.52	C
ATOM	2778	C	GLU	A	374	108.430	67.991	7.949	1.00	40.61	C
ATOM	2779	O	GLU	A	374	108.938	66.870	7.961	1.00	41.45	O
ATOM	2780	CB	GLU	A	374	109.859	69.740	9.003	1.00	40.97	C
ATOM	2781	CG	GLU	A	374	110.940	70.800	8.893	1.00	43.47	C
ATOM	2782	CD	GLU	A	374	110.498	72.042	8.138	1.00	46.43	C
ATOM	2783	OE1	GLU	A	374	109.291	72.384	8.186	1.00	46.56	O
ATOM	2784	OE2	GLU	A	374	111.365	72.704	7.520	1.00	48.05	O
ATOM	2785	N	ALA	A	375	107.132	68.180	8.176	1.00	39.40	N
ATOM	2786	CA	ALA	A	375	106.237	67.053	8.467	1.00	39.33	C
ATOM	2787	C	ALA	A	375	106.201	65.981	7.367	1.00	39.58	C
ATOM	2788	O	ALA	A	375	105.988	66.289	6.194	1.00	40.42	O
ATOM	2789	CB	ALA	A	375	104.827	67.568	8.740	1.00	38.20	C
ATOM	2790	N	PRO	A	376	106.397	64.701	7.742	1.00	39.51	N
ATOM	2791	CA	PRO	A	376	106.400	63.547	6.833	1.00	40.37	C
ATOM	2792	C	PRO	A	376	105.074	63.223	6.115	1.00	42.60	C
ATOM	2793	O	PRO	A	376	105.034	62.339	5.257	1.00	44.07	O
ATOM	2794	CB	PRO	A	376	106.840	62.403	7.751	1.00	38.78	C
ATOM	2795	CG	PRO	A	376	107.612	63.112	8.842	1.00	37.80	C
ATOM	2796	CD	PRO	A	376	106.665	64.236	9.111	1.00	37.56	C
ATOM	2797	N	GLY	A	377	103.992	63.916	6.465	1.00	44.20	N
ATOM	2798	CA	GLY	A	377	102.704	63.657	5.829	1.00	45.51	C
ATOM	2799	C	GLY	A	377	102.780	63.611	4.312	1.00	47.08	C
ATOM	2800	O	GLY	A	377	103.714	64.150	3.720	1.00	47.51	O
ATOM	2801	N	GLU	A	378	101.801	62.968	3.681	1.00	48.24	N
ATOM	2802	CA	GLU	A	378	101.759	62.841	2.221	1.00	48.97	C
ATOM	2803	C	GLU	A	378	100.987	64.015	1.627	1.00	48.92	C
ATOM	2804	O	GLU	A	378	99.905	64.345	2.096	1.00	49.36	O
ATOM	2805	CB	GLU	A	378	101.082	61.523	1.828	1.00	50.65	C
ATOM	2806	CG	GLU	A	378	101.750	60.266	2.409	1.00	56.37	C
ATOM	2807	CD	GLU	A	378	101.682	60.184	3.950	1.00	60.26	C
ATOM	2808	OE1	GLU	A	378	100.554	60.078	4.493	1.00	61.73	O

-continued

ATOM	2809	OE2	GLU	A	378	102.752	60.225	4.619	1.00	60.95	O
ATOM	2810	N	THR	A	379	101.538	64.648	0.598	1.00	48.86	N
ATOM	2811	CA	THR	A	379	100.868	55.786	-0.030	1.00	49.21	C
ATOM	2812	C	THR	A	379	99.683	65.876	-0.911	1.00	49.89	C
ATOM	2813	O	THR	A	379	99.745	64.394	-1.658	1.00	49.37	O
ATOM	2814	CB	THR	A	379	101.845	66.617	-0.903	1.00	48.77	C
ATOM	2815	OG1	THR	A	379	102.921	67.089	-0.087	1.00	49.52	O
ATOM	2816	CG2	THR	A	379	101.133	67.821	-1.527	1.00	46.54	C
ATOM	2817	N	GLU	A	380	98.604	66.147	-0.814	1.00	50.46	N
ATOM	2818	CA	GLU	A	380	97.407	65.905	-1.601	1.00	51.12	C
ATOM	2819	C	GLU	A	380	96.897	67.228	-2.134	1.00	50.88	C
ATOM	2820	O	GLU	A	380	97.110	68.283	-1.538	1.00	49.94	O
ATOM	2821	CB	GLU	A	380	96.322	65.227	-0.758	1.00	51.47	C
ATOM	2822	CG	GLU	A	380	96.762	63.909	-0.168	1.00	53.35	C
ATOM	2823	CD	GLU	A	380	95.633	63.169	0.503	1.00	55.74	C
ATOM	2824	OE1	GLU	A	380	94.962	63.764	1.373	1.00	56.99	O
ATOM	2825	OE2	GLU	A	380	95.421	61.983	0.167	1.00	57.47	O
ATOM	2826	N	ILE	A	381	96.226	67.165	-3.272	1.00	52.06	N
ATOM	2827	CA	ILE	A	381	95.697	68.364	-3.884	1.00	53.51	C
ATOM	2828	C	ILE	A	381	94.196	68.250	-4.113	1.00	53.54	C
ATOM	2829	O	ILE	A	381	93.707	67.300	-4.731	1.00	53.35	O
ATOM	2830	CB	ILE	A	381	96.436	68.676	-5.219	1.00	54.46	C
ATOM	2831	CG1	ILE	A	381	96.307	67.515	-6.199	1.00	54.90	C
ATOM	2832	CG2	ILE	A	381	97.919	68.895	-4.947	1.00	55.14	C
ATOM	2833	CD1	ILE	A	381	97.141	67.712	-7.458	1.00	55.73	C
ATOM	2634	N	TYR	A	382	93.472	69.228	-3.579	1.00	53.11	N
ATOM	2835	CA	TYR	A	382	92.029	69.285	-3.699	1.00	52.90	C
ATOM	2836	C	TYR	A	382	91.669	70.747	-3.928	1.00	52.45	C
ATOM	2837	O	TYR	A	382	92.092	71.623	-3.173	1.00	51.87	O
ATOM	2838	CB	TYR	A	382	91.379	68.732	-2.419	1.00	53.99	C
ATOM	2839	CG	TYR	A	382	89.868	68.819	-2.388	1.00	55.14	C
ATOM	2840	CD1	TYR	A	382	89.221	69.793	-1.623	1.00	55.14	C
ATOM	2841	CD2	TYR	A	382	89.084	67.957	-3.161	1.00	55.70	C
ATOM	2842	CE1	TYR	A	382	87.827	69.910	-1.629	1.00	56.22	C
ATOM	2843	CE2	TYR	A	382	87.688	68.066	-3.177	1.00	56.34	C
ATOM	2844	CZ	TYR	A	382	87.066	69.046	-2.410	1.00	56.68	C
ATOM	2845	OH	TYR	A	382	85.693	69.174	-2.439	1.00	57.02	O
ATOM	2846	N	GLN	A	383	90.903	70.999	-4.987	1.00	52.24	N
ATOM	2847	CA	GLN	A	383	90.484	72.348	-5.358	1.00	52.02	C
ATOM	2848	C	GLN	A	383	91.687	73.210	-5.721	1.00	51.03	C
ATOM	2849	O	GLN	A	383	91.619	74.436	-5.661	1.00	50.67	O
ATOM	2850	CB	GLN	A	383	89.707	73.018	-4.218	1.00	53.91	C
ATOM	2851	CG	GLN	A	383	88.436	72.297	-3.794	1.00	56.88	C
ATOM	2852	CD	GLN	A	383	87.451	72.115	-4.934	1.00	59.26	C
ATOM	2853	OE1	GLN	A	383	87.746	71.441	-5.926	1.00	60.79	O
ATOM	2854	NE2	GLN	A	383	86.270	72.718	-4.800	1.00	59.95	N
ATOM	2855	N	GLY	A	384	92.788	72.562	-6.091	1.00	50.37	N
ATOM	2856	CA	GLY	A	384	93.985	73.292	-6.468	1.00	50.11	C
ATOM	2857	C	GLY	A	384	94.977	73.527	-5.341	1.00	49.99	C
ATOM	2858	O	GLY	A	384	96.185	73.637	-5.586	1.00	50.26	O
ATOM	2859	N	ARG	A	385	94.480	73.610	-4.109	1.00	49.41	N
ATOM	2860	CA	ARG	A	385	95.350	73.837	-2.958	1.00	48.78	C
ATOM	2861	C	ARG	A	385	96.049	72.559	-2.527	1.00	47.90	C
ATOM	2862	O	ARG	A	385	95.536	71.456	-2.727	1.00	47.68	O
ATOM	2863	CB	ARG	A	385	94.563	74.379	-1.761	1.00	49.61	C
ATOM	2864	CG	ARG	A	385	93.830	75.696	-1.980	1.00	51.31	C
ATOM	2865	CD	ARG	A	385	92.522	75.518	-2.727	1.00	52.37	C
ATOM	2866	NE	ARG	A	385	91.851	76.801	-2.898	1.00	54.89	N
ATOM	2867	CZ	ARG	A	385	90.660	76.958	-3.467	1.00	56.27	C
ATOM	2868	NH1	ARG	A	385	89.996	75.905	-3.925	1.00	57.58	N
ATOM	2869	NH2	ARG	A	385	90.135	78.170	-3.581	1.00	55.72	N
ATOM	2870	N	LYS	A	386	97.220	72.712	-1.920	1.00	47.18	N
ATOM	2871	CA	LYS	A	386	97.977	71.561	-1.450	1.00	46.53	C
ATOM	2872	C	LYS	A	386	97.702	71.259	0.022	1.00	45.66	C
ATOM	2873	O	LYS	A	386	97.602	72.166	0.857	1.00	45.07	O
ATOM	2874	CB	LYS	A	386	99.478	71.781	-1.642	1.00	46.65	C
ATOM	2875	CG	LYS	A	386	99.942	71.885	-3.082	1.00	48.06	C
ATOM	2876	CD	LYS	A	386	101.451	72.061	-3.101	1.00	50.09	C
ATOM	2877	CE	LYS	A	386	102.017	72.118	-4.505	1.00	51.55	C
ATOM	2878	HZ	LYS	A	386	103.505	72.226	-4.438	1.00	52.03	N
ATOM	2879	N	TYR	A	387	97.580	69.971	0.326	1.00	45.21	N
ATOM	2880	CA	TYR	A	387	97.335	69.515	1.689	1.00	45.09	C
ATOM	2881	C	TYR	A	387	98.420	68.561	2.155	1.00	44.05	C
ATOM	2882	O	TYR	A	387	99.270	68.119	1.380	1.00	44.31	C
ATOM	2883	CB	TYR	A	387	95.978	68.807	1.787	1.00	45.22	C
ATOM	2884	CG	TYR	A	387	94.799	69.725	1.580	1.00	45.09	C
ATOM	2885	CD1	TYR	A	387	94.537	70.291	0.332	1.00	45.10	C
ATOM	2886	CD2	TYR	A	387	93.981	70.063	2.652	1.00	45.00	C
ATOM	2887	CE1	TYR	A	387	93.492	71.194	0.160	1.00	45.13	C

-continued

ATOM	2888	CE2	TYR	A	387	92.941	70.979	2.491	1.00	45.41	C
ATOM	2889	CZ	TYR	A	387	92.707	71.531	1.246	1.00	45.60	C
ATOM	2890	OH	TYR	A	387	91.701	72.444	1.104	1.00	47.56	O
ATOM	2891	N	LYS	A	388	98.381	68.248	3.438	1.00	43.76	N
ATOM	2892	CA	LYS	A	388	99.328	67.326	4.034	1.00	43.49	C
ATOM	2893	C	LYS	A	388	98.501	66.389	4.865	1.00	41.84	C
ATOM	2894	O	LYS	A	388	97.731	66.834	5.703	1.00	40.70	O
ATOM	2895	CB	LYS	A	388	100.317	68.067	4.932	1.00	45.64	C
ATOM	2896	CG	LYS	A	388	101.504	68.715	4.213	1.00	48.31	C
ATOM	2897	CD	LYS	A	388	102.626	67.706	3.892	1.00	47.96	C
ATOM	2898	CE	LYS	A	388	103.901	68.437	3.466	1.00	47.56	C
ATOM	2899	NZ	LYS	A	388	105.097	67.563	3.426	1.00	46.67	N
ATOM	2900	N	THR	A	389	98.647	65.092	4.617	1.00	42.01	N
ATOM	2901	CA	THR	A	389	97.902	64.098	5.370	1.00	41.89	C
ATOM	2902	C	THR	A	389	98.290	64.224	6.833	1.00	42.40	C
ATOM	2903	O	THR	A	389	99.418	64.598	7.172	1.00	42.02	O
ATOM	2904	CB	THR	A	389	98.218	62.669	4.909	1.00	41.09	C
ATOM	2905	CG1	THR	A	389	99.623	62.427	5.042	1.00	41.52	O
ATOM	2906	CG2	THR	A	389	97.607	62.474	2.461	1.00	41.23	C
ATOM	2907	N	TYR	A	390	97.330	63.930	7.693	1.00	42.51	N
ATOM	2908	CA	TYR	A	390	97.533	63.980	9.125	1.00	42.75	C
ATOM	2909	C	TYR	A	390	96.624	62.882	9.670	1.00	43.43	C
ATOM	2910	O	TYR	A	390	95.406	62.969	9.551	1.00	44.28	O
ATOM	2911	CB	TYR	A	390	97.098	65.332	9.679	1.00	41.44	C
ATOM	2912	CG	TYR	A	390	97.362	65.467	11.159	1.00	40.95	C
ATOM	2913	CD1	TYR	A	390	96.609	66.343	11.944	1.00	41.25	C
ATOM	2914	CD2	TYR	A	390	98.373	64.729	11.777	1.00	39.46	C
ATOM	2915	CE1	TYR	A	390	96.852	66.478	13.312	1.00	40.17	C
ATOM	2916	CE2	TYR	A	390	98.623	64.856	13.136	1.00	40.26	C
ATOM	2917	CZ	TYR	A	390	97.857	65.732	13.896	1.00	39.92	C
ATOM	2918	OH	TYR	A	390	98.095	65.857	15.238	1.00	40.43	O
ATOM	2919	N	ARG	A	391	97.206	61.846	10.258	1.00	44.01	N
ATOM	2920	CA	ARG	A	391	96.399	60.750	10.772	1.00	44.87	C
ATOM	2921	C	ARG	A	391	96.778	60.387	12.202	1.00	45.41	C
ATOM	2922	O	ARG	A	391	97.954	60.450	12.580	1.00	45.88	O
ATOM	2923	CB	ARG	A	391	96.589	59.529	9.883	1.00	44.93	C
ATOM	2924	CG	ARG	A	391	97.990	58.967	9.986	1.00	46.56	C
ATOM	2925	CD	ARG	A	391	98.242	57.872	8.981	1.00	47.95	C
ATOM	2926	NE	ARG	A	391	99.535	57.232	9.200	1.00	48.70	N
ATOM	2927	CZ	ARG	A	391	100.072	56.357	8.363	1.00	49.29	C
ATOM	2928	NH1	ARG	A	391	99.425	56.024	7.252	1.00	50.30	N
ATOM	2929	NH2	ARG	A	391	101.245	55.805	8.638	1.00	49.69	N
ATOM	2930	N	GLY	A	392	95.782	60.009	12.999	1.00	45.56	N
ATOM	2931	CA	GLY	A	392	96.062	59.618	14.366	1.00	45.33	C
ATOM	2932	C	GLY	A	392	96.803	58.291	14.343	1.00	45.81	C
ATOM	2933	O	GLY	A	392	96.578	57.467	13.451	1.00	45.18	O
HETATM	2934	N	MSE	A	393	97.696	58.074	15.304	1.00	46.09	N
HETATM	2935	CA	MSE	A	393	98.437	56.818	15.344	1.00	46.91	C
HETATM	2936	C	MSE	A	393	97.514	55.638	15.668	1.00	45.83	C
HETATM	2937	O	MSE	A	393	97.905	54.474	15.553	1.00	45.29	O
HETATM	2938	CB	MSE	A	393	99.587	56.925	16.351	1.00	48.46	C
HETATM	2939	CG	MSE	A	393	100.671	57.905	15.906	1.00	51.44	C
HETATM	2940	SE	MSE	A	393	101.600	57.363	14.403	1.00	55.48	SE
HETATM	2941	CE	MSE	A	393	102.496	55.927	15.071	1.00	55.49	C
ATOM	2942	N	GLY	A	394	96.280	55.954	16.049	1.00	44.70	N
ATOM	2943	CA	GLY	A	394	95.307	54.926	16.364	1.00	44.19	C
ATOM	2944	C	GLY	A	394	94.355	54.686	15.206	1.00	44.14	C
ATOM	2945	O	GLY	A	394	93.416	53.896	15.311	1.00	43.61	O
ATOM	2946	N	SER	A	395	94.591	55.369	14.093	1.00	44.85	N
ATOM	2947	CA	SER	A	395	93.740	55.204	12.921	1.00	45.69	C
ATOM	2948	C	SER	A	395	94.061	53.866	12.265	1.00	46.80	C
ATOM	2949	O	SER	A	395	95.002	53.175	12.663	1.00	47.02	O
ATOM	2950	CB	SER	A	395	93.968	56.340	11.916	1.00	45.01	C
ATOM	2951	OG	SER	A	395	95.278	56.305	11.372	1.00	44.71	O
ATOM	2952	N	ILE	A	396	93.276	53.501	11.261	1.00	47.68	N
ATOM	2953	CA	ILE	A	396	93.488	52.245	10.554	1.00	49.11	C
ATOM	2954	C	ILE	A	396	94.830	52.246	9.797	1.00	49.53	C
ATOM	2955	O	ILE	A	396	95.705	51.418	10.070	1.00	48.83	O
ATOM	2956	CB	ILE	A	396	92.320	51.974	9.558	1.00	49.53	C
ATOM	2957	CG1	ILE	A	396	90.990	51.908	10.315	1.00	49.28	C
ATOM	2958	CG2	ILE	A	396	92.554	50.670	8.812	1.00	49.14	C
ATOM	2959	CD1	ILE	A	396	90.932	50.820	11.363	1.00	49.48	C
ATOM	2960	N	ALA	A	397	94.988	53.183	8.863	1.00	50.24	N
ATOM	2961	CA	ALA	A	397	96.206	53.291	8.062	1.00	51.94	C
ATOM	2962	C	ALA	A	397	97.475	53.255	8.903	1.00	53.51	C
ATOM	2963	O	ALA	A	397	98.414	52.533	8.576	1.00	53.35	O
ATOM	2964	CB	ALA	A	397	96.177	54.567	7.227	1.00	50.87	C
ATOM	2965	N	ALA	A	398	97.507	54.037	9.979	1.00	55.56	N
ATOM	2966	CA	ALA	A	398	98.677	54.074	10.851	1.00	57.66	C

-continued

ATOM	2967	C	ALA	A	398	98.878	52.719	11.529	1.00	59.35	C
ATOM	2968	O	ALA	A	398	99.988	52.181	11.541	1.00	59.25	O
ATOM	2969	CB	ALA	A	398	98.525	55.175	11.900	1.00	56.88	C
HETATM	2970	N	MSE	A	399	97.803	52.162	12.084	1.00	61.57	N
HETATM	2971	CA	MSE	A	399	97.883	50.868	12.753	1.00	63.53	C
HETATM	2972	C	MSE	A	399	98.165	49.736	11.778	1.00	64.22	C
HETATM	2973	O	MSE	A	399	98.294	48.586	12.181	1.00	64.45	O
HETATM	2974	CB	MSE	A	399	96.589	50.561	13.510	1.00	64.53	C
HETATM	2975	CG	MSE	A	399	96.335	51.428	14.726	1.00	66.17	C
HETATM	2976	SE	MSE	A	399	94.927	50.801	15.688	1.00	70.47	SE
HETATM	2977	CE	MSE	A	399	93.579	50.893	14.454	1.00	68.03	C
ATOM	2978	N	LYS	A	400	98.275	50.067	10.498	1.00	65.70	N
ATOM	2979	CA	LYS	A	400	98.535	49.076	9.461	1.00	67.25	C
ATOM	2980	C	LYS	A	400	99.753	48.195	9.743	1.00	68.24	C
ATOM	2981	O	LYS	A	400	100.162	48.015	10.888	1.00	68.63	O
ATOM	2982	CB	LYS	A	400	98.703	49.771	8.118	1.00	67.70	C
ATOM	2983	N	LYS	A	401	100.324	47.646	8.677	1.00	69.15	N
ATOM	2984	CA	LYS	A	401	101.487	46.771	8.773	1.00	70.20	C
ATOM	2985	C	LYS	A	401	102.588	47.357	9.662	1.00	71.05	C
ATOM	2986	O	LYS	A	401	102.394	48.471	10.197	1.00	71.27	O
ATOM	2987	CB	LYS	A	401	102.035	46.483	7.365	1.00	69.48	C
ATOM	2988	N	ASN	A	416	92.074	47.487	5.186	1.00	72.24	N
ATOM	2989	CA	ASN	A	416	91.155	46.876	6.194	1.00	72.64	C
ATOM	2990	C	ASN	A	416	91.165	47.666	7.501	1.00	72.60	C
ATOM	2991	O	ASN	A	416	92.209	48.176	7.915	1.00	73.31	O
ATOM	2992	CB	ASN	A	416	91.563	45.422	6.465	1.00	72.21	C
ATOM	2993	N	LYS	A	417	90.004	47.744	8.152	1.00	71.58	N
ATOM	2994	CA	LYS	A	417	89.858	48.463	9.419	1.00	70.32	C
ATOM	2995	C	LYS	A	417	89.985	47.484	10.580	1.00	69.53	C
ATOM	2996	O	LYS	A	417	89.416	46.386	10.515	1.00	70.17	O
ATOM	2997	CB	LYS	A	417	88.499	49.146	9.472	1.00	70.50	C
ATOM	2998	N	LEU	A	418	90.712	47.870	11.642	1.00	67.91	N
ATOM	2999	CA	LEU	A	418	90.903	46.996	12.826	1.00	64.90	C
ATOM	3000	C	LEU	A	418	90.637	47.647	14.211	1.00	62.37	C
ATOM	3001	O	LEU	A	418	91.478	47.559	15.111	1.00	62.60	O
ATOM	3002	CB	LEU	A	418	92.286	46.414	12.785	1.00	64.79	C
ATOM	3003	N	VAL	A	419	99.455	48.260	14.362	1.00	59.18	N
ATOM	3004	CA	VAL	A	419	88.983	48.973	15.576	1.00	56.04	C
ATOM	3005	C	VAL	A	419	89.820	50.195	15.995	1.00	53.39	C
ATOM	3006	O	VAL	A	419	90.533	50.180	17.005	1.00	51.68	O
ATOM	3007	CB	VAL	A	419	88.825	48.027	16.790	1.00	56.09	C
ATOM	3008	CG1	VAL	A	419	88.330	48.818	18.006	1.00	55.27	C
ATOM	3009	CG2	VAL	A	419	87.823	46.925	16.456	1.00	56.32	C
ATOM	3010	N	PRO	A	420	89.728	51.280	15.207	1.00	51.10	N
ATOM	3011	CA	PRO	A	420	90.430	52.548	15.402	1.00	49.87	C
ATOM	3012	C	PRO	A	420	89.937	53.428	16.559	1.00	48.67	C
ATOM	3013	O	PRO	A	420	88.758	53.419	16.924	1.00	47.55	O
ATOM	3014	CB	PRO	A	420	90.238	53.225	14.052	1.00	49.97	C
ATOM	3015	CG	PRO	A	420	88.824	52.828	13.734	1.00	49.16	C
ATOM	3016	CD	PRO	A	420	88.939	51.338	13.961	1.00	49.81	C
ATOM	3017	N	GLU	A	421	90.871	54.192	17.116	1.00	48.34	N
ATOM	3018	CA	GLU	A	421	90.610	55.123	18.208	1.00	47.97	C
ATOM	3019	C	GLU	A	421	90.154	56.506	17.668	1.00	46.84	C
ATOM	3020	O	GLU	A	421	91.005	57.481	18.409	1.00	47.51	O
ATOM	3021	CB	GLU	A	421	91.517	54.809	19.396	1.00	49.79	C
ATOM	3022	CG	GLU	A	421	91.207	53.512	20.149	1.00	53.19	C
ATOM	3023	CD	GLU	A	421	90.329	53.739	21.372	1.00	53.99	C
ATOM	3024	OE1	GLU	A	421	90.730	54.563	22.228	1.00	55.23	O
ATOM	3025	OE2	GLU	A	421	89.260	53.095	21.484	1.00	53.71	O
ATOM	3026	N	GLY	A	422	91.200	56.576	16.366	1.00	45.35	N
ATOM	3027	CA	GLY	A	422	91.541	57.834	15.736	1.00	44.97	C
ATOM	3028	C	GLY	A	422	91.214	57.813	14.253	1.00	44.86	C
ATOM	3029	O	GLY	A	422	90.918	56.760	13.684	1.00	44.42	O
ATOM	3030	N	ILE	A	423	91.279	58.974	13.611	1.00	44.45	N
ATOM	3031	CA	ILE	A	423	90.954	59.045	12.196	1.00	43.46	C
ATOM	3032	C	ILE	A	423	92.129	59.498	11.321	1.00	42.96	C
ATOM	3033	O	ILE	A	423	93.178	59.916	11.821	1.00	41.95	O
ATOM	3034	CB	ILE	A	423	89.703	59.963	11.970	1.00	43.06	C
ATOM	3035	CG1	ILE	A	423	89.978	61.412	12.403	1.00	42.83	C
ATOM	3036	CG2	ILE	A	423	88.534	59.439	12.788	1.00	41.55	O
ATOM	3037	CD1	ILE	A	423	90.868	62.208	11.461	1.00	43.42	C
ATOM	3038	N	GLU	A	424	91.934	59.387	10.012	1.00	42.19	N
ATOM	3039	CA	GLU	A	424	92.931	59.775	9.024	1.00	42.21	C
ATOM	3040	C	GLU	A	424	92.422	61.047	8.363	1.00	41.48	C
ATOM	3041	O	GLU	A	424	91.266	61.110	7.945	1.00	41.26	O
ATOM	3042	CB	GLU	A	424	93.071	58.680	7.963	1.00	43.26	C
ATOM	3043	CG	GLU	A	424	93.518	57.325	8.492	1.00	45.35	C
ATOM	3044	CD	GLU	A	424	93.357	56.225	7.453	1.00	46.93	C
ATOM	3045	OE1	GLU	A	424	93.818	56.423	6.305	1.00	48.20	O

-continued

ATOM	3046	OE2	GLU	A	424	92.780	55.162	7.780	1.00	46.63	O
ATOM	3047	N	GLY	A	425	93.276	62.060	8.270	1.00	41.08	N
ATOM	3048	CA	GLY	A	425	92.857	63.303	7.643	1.00	40.46	C
ATOM	3049	C	GLY	A	425	93.976	64.030	6.920	1.00	40.17	C
ATOM	3050	O	GLY	A	425	95.017	63.446	6.609	1.00	39.82	O
ATOM	3051	N	ARG	A	426	93.757	65.309	6.643	1.00	39.48	N
ATOM	3052	CA	ARG	A	426	94.753	66.117	5.967	1.00	39.94	C
ATOM	3053	C	ARG	A	426	94.571	67.562	6.375	1.00	40.26	C
ATOM	3054	O	ARG	A	426	93.486	67.963	6.792	1.00	41.45	O
ATOM	3055	CB	ARG	A	426	94.608	65.989	4.452	1.00	39.82	C
ATOM	3056	CG	ARG	A	426	93.320	66.554	3.892	1.00	41.77	C
ATOM	3057	CD	ARG	A	426	93.202	66.182	2.405	1.00	43.77	C
ATOM	3058	NE	ARG	A	426	92.026	66.747	1.751	1.00	45.14	N
ATOM	3059	CZ	ARG	A	426	91.654	66.455	0.506	1.00	46.18	C
ATOM	3060	NH1	ARG	A	426	92.366	65.604	-0.218	1.00	46.99	N
ATOM	3061	NH2	ARG	A	426	90.577	67.021	-0.021	1.00	47.23	N
ATOM	3062	N	VAL	A	427	95.640	68.342	6.267	1.00	40.61	N
ATOM	3063	CA	VAL	A	427	95.592	69.759	6.613	1.00	40.23	C
ATOM	3064	C	VAL	A	427	96.338	70.557	5.548	1.00	40.03	C
ATOM	3065	O	VAL	A	427	97.235	70.033	4.885	1.00	39.67	O
ATOM	3066	CE	VAL	A	427	96.225	70.029	8.001	1.00	39.28	C
ATOM	3067	CG1	VAL	A	427	95.457	69.280	9.079	1.00	37.97	C
ATOM	3068	CG2	VAL	A	427	97.681	69.609	7.993	1.00	39.20	C
ATOM	3069	N	ALA	A	429	95.945	71.815	5.381	1.00	40.23	N
ATOM	3070	CA	ALA	A	428	96.562	72.700	4.406	1.00	41.04	C
ATOM	3071	C	ALA	A	428	98.079	72.829	4.595	1.00	42.53	C
ATOM	3072	O	ALA	A	428	98.578	72.780	5.727	1.00	42.82	O
ATOM	3073	CB	ALA	A	428	95.918	74.074	4.496	1.00	39.46	C
ATOM	3074	N	TYR	A	429	98.801	72.975	3.480	1.00	42.74	N
ATOM	3075	CA	TYR	A	429	100.251	73.168	3.491	1.00	43.20	C
ATOM	3076	C	TYR	A	429	100.546	74.452	4.284	1.00	42.09	C
ATOM	3077	O	TYR	A	429	99.986	75.509	3.984	1.00	41.87	O
ATOM	3078	CB	TYR	A	429	100.757	73.332	2.061	1.00	44.90	C
ATOM	3079	CG	TYR	A	429	102.211	73.730	1.972	1.00	48.81	C
ATOM	3080	CD1	TYR	A	429	103.228	72.842	2.329	1.00	50.14	C
ATOM	3081	CD2	TYR	A	429	102.574	75.005	1.541	1.00	49.88	C
ATOM	3082	CE1	TYR	A	429	104.575	73.214	2.255	1.00	50.62	C
ATOM	3083	CE2	TYR	A	429	103.915	75.388	1.463	1.00	50.81	C
ATOM	3084	CZ	TYR	A	429	104.908	74.487	1.819	1.00	50.86	C
ATOM	3085	OH	TYR	A	429	106.226	74.863	1.718	1.00	50.47	O
ATOM	3086	N	LYS	A	430	101.429	74.372	5.276	1.00	40.05	N
ATOM	3087	CA	LYS	A	430	101.727	75.541	6.102	1.00	38.56	C
ATOM	3088	C	LYS	A	430	103.086	76.198	5.889	1.00	37.11	C
ATOM	3089	O	LYS	A	430	103.360	77.238	6.486	1.00	37.51	O
ATOM	3090	CB	LYS	A	430	101.610	75.178	7.589	1.00	38.70	C
ATOM	3091	CG	LYS	A	430	100.294	74.563	7.981	1.00	38.40	C
ATOM	3092	CD	LYS	A	430	100.284	74.152	9.434	1.00	38.43	C
ATOM	3093	CE	LYS	A	430	98.997	73.409	9.738	1.00	39.27	C
ATOM	3094	NZ	LYS	A	430	98.927	72.970	11.149	1.00	40.88	N
ATOM	3095	N	GLY	A	431	103.942	75.609	5.063	1.00	35.54	N
ATOM	3096	CA	GLY	A	431	105.256	76.199	4.867	1.00	32.89	C
ATOM	3097	C	GLY	A	431	106.199	75.798	5.991	1.00	31.20	C
ATOM	3098	O	GLY	A	431	105.927	74.847	6.710	1.00	30.24	O
ATOM	3099	N	ALA	A	432	107.296	76.528	6.157	1.00	30.60	N
ATOM	3100	CA	ALA	A	432	108.290	76.214	7.189	1.00	29.98	C
ATOM	3101	C	ALA	A	432	107.759	76.197	8.618	1.00	29.06	C
ATOM	3102	O	ALA	A	432	106.981	77.057	9.018	1.00	30.18	O
ATOM	3103	CB	ALA	A	432	109.462	77.188	7.097	1.00	29.00	C
ATOM	3104	N	ALA	A	433	108.206	75.216	9.390	1.00	27.87	N
ATOM	3105	CA	ALA	A	433	107.798	75.077	10.777	1.00	27.30	C
ATOM	3106	C	ALA	A	433	108.341	76.225	11.624	1.00	27.35	C
ATOM	3107	O	ALA	A	433	107.727	76.611	12.620	1.00	27.15	O
ATOM	3108	CB	ALA	A	433	108.289	73.739	11.333	1.00	28.08	C
ATOM	3109	N	SER	A	434	109.493	76.766	11.238	1.00	26.71	N
ATOM	3110	CA	SER	A	434	110.085	77.875	11.983	1.00	27.06	C
ATOM	3111	C	SER	A	434	109.131	79.070	12.036	1.00	26.79	C
ATOM	3112	O	SER	A	434	109.120	79.821	13.014	1.00	25.57	O
ATOM	3113	CB	SER	A	434	111.419	76.306	11.357	1.00	27.17	C
ATOM	3114	OG	SER	A	434	111.252	78.778	10.031	1.00	28.63	O
ATOM	3115	N	ASP	A	435	108.333	79.243	10.986	1.00	27.24	N
ATOM	3116	CA	ASP	A	435	107.363	80.333	10.928	1.00	28.29	C
ATOM	3117	C	ASP	A	435	106.188	80.060	11.868	1.00	27.92	C
ATOM	3118	O	ASP	A	435	105.714	80.959	12.565	1.00	28.07	O
ATOM	3119	CB	ASP	A	435	106.876	80.517	9.491	1.00	31.68	C
ATOM	3120	CG	ASP	A	435	107.949	81.120	8.579	1.00	35.77	C
ATOM	3121	OD1	ASP	A	435	107.761	81.087	7.341	1.00	38.23	O
ATOM	3122	OD2	ASP	A	435	108.968	81.643	9.096	1.00	36.12	O
ATOM	3123	N	ILE	A	436	105.726	78.815	11.886	1.00	26.54	N
ATOM	3124	CA	ILE	A	436	104.637	78.398	12.763	1.00	25.99	C

-continued

ATOM	3125	C	ILE	A	436	105.085	78.679	14.199	1.00	24.91	C
ATOM	3126	O	ILE	A	436	104.388	79.320	14.977	1.00	23.37	O
ATOM	3127	CB	ILE	A	436	104.357	76.867	12.617	1.00	26.46	C
ATOM	3128	CG1	ILE	A	436	104.016	76.524	11.166	1.00	28.02	C
ATOM	3129	CG2	ILE	A	436	103.236	76.437	13.536	1.00	26.46	C
ATOM	3130	CD1	ILE	A	436	102.860	77.292	10.604	1.00	30.24	C
ATOM	3131	N	VAL	A	437	106.268	76.191	14.539	1.00	25.92	N
ATOM	3132	CA	VAL	A	437	106.804	78.383	15.877	1.00	27.27	C
ATOM	3133	C	VAL	A	437	106.902	79.853	16.244	1.00	28.27	C
ATOM	3134	O	VAL	A	437	106.560	80.238	17.367	1.00	29.71	O
ATOM	3135	CB	VAL	A	437	108.200	77.747	16.022	1.00	26.18	C
ATOM	3136	CG1	VAL	A	437	108.770	78.055	17.395	1.00	25.87	C
ATOM	3137	CG2	VAL	A	437	108.105	76.244	15.821	1.00	26.99	C
ATOM	3138	N	PHE	A	438	107.367	80.678	15.307	1.00	29.44	N
ATOM	3139	CA	PHE	A	438	107.513	82.104	15.564	1.00	29.34	C
ATOM	3140	C	PHE	A	438	106.182	82.759	15.872	1.00	29.77	C
ATOM	3141	O	PHE	A	438	106.110	83.647	16.721	1.00	29.60	O
ATOM	3142	CE	PHE	A	438	108.183	82.799	14.382	1.00	30.41	C
ATOM	3143	CG	PHE	A	436	108.391	84.262	14.589	1.00	32.43	C
ATOM	3144	CD1	PHE	A	438	107.342	85.160	14.424	1.00	34.66	C
ATOM	3145	CD2	PHE	A	438	109.625	84.742	15.012	1.00	34.35	C
ATOM	3146	CE1	PHE	A	438	107.514	86.522	14.678	1.00	35.25	C
ATOM	3147	CE2	PHE	A	438	109.816	86.100	15.273	1.00	35.59	C
ATOM	3148	CZ	PHE	A	438	108.752	86.994	15.105	1.00	36.08	C
ATOM	3149	N	GLN	A	439	105.125	82.325	15.189	1.00	31.03	N
ATOM	3150	CA	GLN	A	439	103.801	82.885	15.440	1.00	31.99	C
ATOM	3151	C	GLN	A	439	103.280	82.473	16.803	1.00	32.50	C
ATOM	3152	O	GLN	A	439	102.669	83.282	17.502	1.00	33.67	O
ATOM	3153	CB	GLN	A	439	102.801	82.454	14.369	1.00	33.33	C
ATOM	3154	CG	GLN	A	439	102.962	83.175	13.052	1.00	36.37	C
ATOM	3155	CD	GLN	A	439	102.863	84.685	13.204	1.00	38.29	C
ATOM	3156	NE1	GLN	A	439	101.882	85.212	13.746	1.00	39.62	O
ATOM	3157	NE2	GLN	A	439	103.880	85.393	12.720	1.00	39.30	N
HETATM	3158	N	MSE	A	440	103.519	81.225	17.199	1.00	31.91	N
HETATM	3159	CA	MSE	A	440	103.036	80.797	18.498	1.00	32.48	C
HETATM	3160	C	MSE	A	440	103.802	81.394	19.682	1.00	30.42	C
HETATM	3161	O	MSE	A	440	103.199	81.680	20.718	1.00	29.98	O
HETATM	3162	CB	MSE	A	440	102.958	79.261	18.577	1.00	36.61	C
HETATM	3163	CG	MSE	A	440	104.200	78.483	18.205	1.00	44.35	C
HETATM	3164	SE	MSE	A	440	103.911	76.661	18.242	1.00	53.13	SE
HETATM	3165	CE	MSE	A	440	102.652	76.462	16.958	1.00	51.30	C
ATOM	3166	N	LEU	A	441	105.107	81.620	19.543	1.00	27.53	N
ATOM	3167	CA	LEU	A	441	105.867	82.206	20.648	1.00	25.82	C
ATOM	3168	C	LEU	A	441	105.407	83.644	20.911	1.00	25.88	C
ATOM	3169	O	LEU	A	441	105.348	84.092	22.053	1.00	26.91	O
ATOM	3170	CB	LEU	A	441	107.370	82.194	20.353	1.00	25.33	C
ATOM	3171	CG	LEU	A	441	108.062	80.839	20.155	1.00	25.97	C
ATOM	3172	CD1	LEU	A	441	109.552	81.080	19.937	1.00	25.09	C
ATOM	3173	CD2	LEU	A	441	107.849	79.940	21.362	1.00	25.75	C
ATOM	3174	N	GLY	A	442	105.076	84.366	19.850	1.00	24.13	N
ATOM	3175	CA	GLY	A	442	104.621	85.731	20.019	1.00	23.31	C
ATOM	3176	C	GLY	A	442	103.358	85.780	20.849	1.00	23.82	C
ATOM	3177	O	GLY	A	442	103.200	86.656	21.693	1.00	22.98	O
ATOM	3178	N	GLY	A	443	102.456	84.834	20.605	1.00	24.50	N
ATOM	3179	CA	GLY	A	443	101.207	84.775	21.347	1.00	24.02	C
ATOM	3180	C	GLY	A	443	101.449	84.354	22.781	1.00	24.08	C
ATOM	3181	O	GLY	A	443	100.773	84.822	23.696	1.00	23.64	O
ATOM	3182	N	ILE	A	444	102.419	83.465	22.970	1.00	24.21	N
ATOM	3183	CA	ILE	A	444	102.780	82.979	24.300	1.00	24.08	C
ATOM	3184	C	ILE	A	444	103.376	84.135	25.106	1.00	24.11	C
ATOM	3185	O	ILE	A	444	103.005	84.346	26.261	1.00	23.54	O
ATOM	3186	CB	ILE	A	444	103.798	81.801	24.209	1.00	23.72	C
ATOM	3187	CG1	ILE	A	444	103.152	80.622	23.466	1.00	22.82	C
ATOM	3188	CG2	ILE	A	444	104.241	81.360	25.612	1.00	22.84	C
ATOM	3189	CD1	ILE	A	444	104.110	79.479	23.146	1.00	22.36	C
ATOM	3190	N	ARG	A	445	104.289	84.890	24.500	1.00	23.72	N
ATOM	3191	CA	ARG	A	445	104.883	86.030	25.195	1.00	24.00	C
ATOM	3192	C	ARG	A	445	103.837	87.106	25.514	1.00	23.44	C
ATOM	3193	O	ARG	A	445	103.891	87.721	26.576	1.00	24.01	O
ATOM	3194	CB	ARG	A	445	106.026	86.625	24.372	1.00	22.89	C
ATOM	3195	CG	ARG	A	445	107.275	85.752	24.332	1.00	24.88	C
ATOM	3196	CD	ARG	A	445	105.356	86.373	23.456	1.00	26.53	C
ATOM	3197	NE	ARG	A	445	109.592	85.596	23.462	1.00	27.53	N
ATOM	3198	CZ	ARG	A	445	110.470	85.579	24.464	1.00	30.01	C
ATOM	3199	NH1	ARG	A	445	110.262	86.303	25.561	1.00	28.96	N
ATOM	3200	NH2	ARG	A	445	111.559	84.823	24.372	1.00	29.00	N
ATOM	3201	N	SER	A	446	102.882	87.333	24.615	1.00	23.77	N
ATOM	3202	CA	SER	A	446	101.835	88.322	24.878	1.00	24.75	C
ATOM	3203	C	SER	A	446	100.953	87.831	26.004	1.00	23.48	C

-continued

ATOM	3204	O	SER	A	446	100.605	88.585	26.902	1.00	24.41	C
ATOM	3205	CB	SER	A	446	100.953	88.558	23.656	1.00	25.42	C
ATOM	3206	OG	SER	A	44E	101.715	89.056	22.574	1.00	34.14	O
ATOM	3207	N	GLY	A	447	100.587	86.559	25.946	1.00	22.70	N
ATOM	3208	CA	GLY	A	447	99.740	85.996	26.974	1.00	23.15	C
ATOM	3209	C	GLY	A	447	100.366	86.119	28.338	1.00	23.47	C
ATOM	3210	O	GLY	A	447	99.707	86.531	29.288	1.00	24.01	O
HETATM	3211	N	MSE	A	448	101.641	85.754	28.435	1.00	24.62	N
HETATM	3212	CA	MSE	A	448	102.369	85.834	29.693	1.00	25.24	C
HETATM	3213	C	MSE	A	448	102.566	87.302	30.112	1.00	24.99	C
HETATM	3214	O	MSE	A	448	102.632	87.613	31.300	1.00	25.75	O
HETATM	3215	CB	MSE	A	448	103.704	85.090	29.569	1.00	27.58	C
HETATM	3216	CG	MSE	A	448	103.522	83.600	29.220	1.00	31.58	C
HETATM	3217	SE	MSE	A	448	105.040	82.559	29.094	1.00	37.58	SE
HETATM	3218	CE	MSE	A	448	105.621	82.613	30.821	1.00	34.91	C
ATOM	3219	N	GLY	A	449	102.639	88.208	29.145	1.00	24.08	N
ATOM	3220	CA	GLY	A	449	102.770	89.613	29.487	1.00	24.66	C
ATOM	3221	C	GLY	A	449	101.497	90.132	20.154	1.00	25.65	C
ATOM	3222	O	GLY	A	449	101.550	90.876	31.131	1.00	25.66	C
ATOM	3223	N	TYR	A	450	100.341	89.739	29.626	1.00	25.60	N
ATOM	3224	CA	TYR	A	450	99.059	90.166	30.178	1.00	25.77	C
ATOM	3225	C	TYR	A	450	98.831	89.753	31.623	1.00	24.83	C
ATOM	3226	O	TYR	A	450	98.211	90.485	32.375	1.00	25.34	O
ATOM	3227	CB	TYR	A	450	97.899	89.622	29.344	1.00	26.05	C
ATOM	3228	CG	TYR	A	450	97.590	90.402	28.096	1.00	27.41	C
ATOM	3229	CD1	TYR	A	450	97.111	91.706	28.167	1.00	28.14	C
ATOM	3230	CD2	TYR	A	450	97.749	89.826	26.839	1.00	28.61	C
ATOM	3231	CE1	TYR	A	450	96.793	92.419	27.007	1.00	29.06	C
ATOM	3232	CE2	TYR	A	450	97.436	90.530	25.678	1.00	29.51	C
ATOM	3233	CZ	TYR	A	450	96.959	91.822	25.770	1.00	29.28	C
ATOM	3234	OH	TYR	A	450	96.640	92.501	24.618	1.00	30.87	O
ATOM	3235	N	VAL	A	451	99.305	88.576	32.010	1.00	24.89	N
ATOM	3236	CA	VAL	A	451	99.098	88.121	33.376	1.00	25.62	C
ATOM	3237	C	VAL	A	451	100.316	88.418	34.251	1.00	26.97	C
ATOM	3238	O	VAL	A	451	100.343	88.080	35.434	1.00	27.47	O
ATOM	3239	CB	VAL	A	451	98.758	86.605	33.417	1.00	24.80	C
ATOM	3240	CG1	VAL	A	451	97.465	86.346	32.657	1.00	22.49	C
ATOM	3241	CG2	VAL	A	451	99.884	85.787	32.822	1.00	24.04	C
ATOM	3242	N	GLY	A	452	101.318	89.061	33.655	1.00	28.11	N
ATOM	3243	CA	GLY	A	452	102.518	89.425	34.384	1.00	28.84	C
ATOM	3244	C	GLY	A	452	103.396	88.273	34.816	1.00	30.29	C
ATOM	3245	O	GLY	A	452	104.016	88.325	35.873	1.00	30.53	O
ATOM	3246	N	ALA	A	453	103.461	87.231	33.998	1.00	30.98	N
ATOM	3247	CA	ALA	A	453	104.278	86.065	34.312	1.00	31.22	C
ATOM	3248	C	ALA	A	453	105.623	86.177	33.612	1.00	31.80	C
ATOM	3249	O	ALA	A	453	105.694	86.079	32.386	1.00	32.94	O
ATOM	3250	CB	ALA	A	453	103.567	84.800	33.862	1.00	30.42	C
ATOM	3251	N	GLY	A	454	106.686	86.380	4.387	1.00	31.10	N
ATOM	3252	CA	GLY	A	454	108.015	86.497	33.806	1.00	30.70	C
ATOM	3253	C	GLY	A	454	108.595	85.166	33.359	1.00	30.23	C
ATOM	3254	O	GLY	A	454	109.509	85.117	32.534	1.00	29.71	O
ATOM	3255	N	ASP	A	455	108.076	84.086	33.930	1.00	30.07	N
ATOM	3256	CA	ASP	A	455	108.504	82.742	33.583	1.00	30.58	C
ATOM	3257	C	ASP	A	455	107.326	81.825	33.830	1.00	30.31	C
ATOM	3258	O	ASP	A	455	106.353	82.228	34.463	1.00	30.69	O
ATOM	3259	CB	ASP	A	455	109.701	82.290	34.426	1.00	32.56	C
ATOM	3260	CG	ASP	A	455	109.415	82.301	35.919	1.00	34.66	C
ATOM	3261	OD1	ASP	A	455	108.311	81.896	36.331	1.00	36.16	O
ATOM	3262	OD2	ASP	A	455	110.313	82.688	36.694	1.00	38.54	O
ATOM	3263	N	ILE	A	456	107.412	80.593	33.343	1.00	29.95	N
ATOM	3264	CA	ILE	A	456	106.326	79.634	33.502	1.00	30.50	C
ATOM	3265	C	ILE	A	456	105.976	79.367	34.957	1.00	31.87	C
ATOM	3266	O	ILE	A	456	104.820	79.103	35.274	1.00	32.52	O
ATOM	3267	CB	ILE	A	456	106.657	78.302	32.791	1.00	29.40	C
ATOM	3268	CG1	ILE	A	456	106.775	78.555	31.287	1.00	29.89	C
ATOM	3269	CG2	ILE	A	456	105.589	77.259	33.082	1.00	28.25	C
ATOM	3270	CD1	ILE	A	456	107.179	77.342	30.477	1.00	31.58	C
ATOM	3271	N	GLN	A	457	106.964	79.445	35.844	1.00	32.73	N
ATOM	3272	CA	GLN	A	457	106.718	79.207	37.264	1.00	33.99	C
ATOM	3273	C	GLN	A	457	105.672	80.193	37.801	1.00	33.89	C
ATOM	3274	O	GLN	A	457	104.718	79.800	38.477	1.00	33.85	C
ATOM	3275	CB	GLN	A	457	108.021	79.349	38.049	1.00	36.03	C
ATOM	3276	CG	GLN	A	457	107.883	79.030	39.528	1.00	41.19	C
ATOM	3277	CD	GLN	A	457	109.173	79.257	40.300	1.00	44.64	C
ATOM	3278	OE1	GLN	A	457	110.235	78.745	39.930	1.00	46.35	O
ATOM	3279	NE2	GLN	A	457	109.084	80.019	41.386	1.00	46.46	N
ATOM	3280	N	GLU	A	458	105.860	81.475	37.494	1.00	33.67	N
ATOM	3281	CA	GLU	A	458	104.937	82.523	37.925	1.00	32.88	C
ATOM	3282	C	GLU	A	458	103.574	82.270	37.315	1.00	30.94	C

-continued

ATOM	3283	O	GLU	A	458	102.542	82.607	37.889	1.00	30.37	O
ATOM	3284	CB	GLU	A	458	105.436	83.899	37.478	1.00	33.84	C
ATOM	3285	CG	GLU	A	458	106.617	84.441	38.255	1.00	36.71	C
ATOM	3286	CD	GLU	A	458	107.151	85.736	37.661	1.00	39.24	C
ATOM	3287	OE1	GLU	A	458	106.336	86.630	37.337	1.00	39.29	O
ATOM	3288	OE2	GLU	A	458	108.390	85.867	37.532	1.00	41.42	O
ATOM	3289	N	LEU	A	459	103.587	81.673	36.137	1.00	30.11	N
ATOM	3290	CA	LEU	A	459	102.365	81.363	35.424	1.00	29.90	C
ATOM	3291	C	LEU	A	459	101.543	80.371	36.251	1.00	30.10	C
ATOM	3292	O	LEU	A	459	100.340	80.560	36.446	1.00	30.22	O
ATOM	3293	CB	LEU	A	459	102.725	80.779	34.056	1.00	29.44	C
ATOM	3294	CG	LEU	A	459	101.699	80.716	32.938	1.00	28.07	C
ATOM	3295	CD1	LEU	A	459	101.087	82.092	32.708	1.00	27.42	C
ATOM	3296	CD2	LEU	A	459	102.404	80.226	31.689	1.00	26.36	C
ATOM	3297	N	HIS	A	460	102.190	79.322	36.754	1.00	30.22	N
ATOM	3298	CA	HIS	A	460	101.483	78.337	37.561	1.00	30.19	C
ATOM	3299	C	HIS	A	460	100.980	78.973	38.850	1.00	30.56	C
ATOM	3300	O	MIS	A	460	99.824	78.792	39.228	1.00	30.63	O
ATOM	3301	CB	HIS	A	460	102.378	77.138	37.927	1.00	30.63	C
ATOM	3302	CC	MIS	A	460	102.860	76.337	36.753	1.00	31.06	C
ATOM	3303	ND1	HIS	A	460	102.178	76.270	35.558	1.00	31.79	N
ATOM	3304	CD2	HIS	A	460	103.925	75.507	36.620	1.00	31.34	C
ATOM	3305	CE1	HIS	A	460	102.802	75.437	34.742	1.00	31.58	C
ATOM	3306	NE2	HIS	A	460	103.865	74.959	35.361	1.00	30.54	N
ATOM	3307	N	GLU	A	461	101.853	79.733	39.509	1.00	31.26	N
ATOM	3308	CA	GLU	A	461	101.538	80.387	40.789	1.00	32.15	C
ATOM	3309	C	GLU	A	461	100.548	81.562	40.795	1.00	30.88	C
ATOM	3310	O	GLU	A	461	99.740	81.687	41.715	1.00	29.77	O
ATOM	3311	CB	GLU	A	461	102.833	80.887	41.457	1.00	33.27	C
ATOM	3312	CG	GLU	A	461	103.899	79.832	41.728	1.00	35.31	C
ATOM	3313	CD	GLU	A	461	103.422	78.711	42.633	1.00	36.84	C
ATOM	3314	OE1	GLU	A	461	102.952	78.986	43.758	1.00	37.87	O
ATOM	3315	OE2	GLU	A	461	103.533	77.543	42.214	1.00	40.15	O
ATOM	3316	N	ASN	A	462	100.616	82.417	39.779	1.00	29.95	N
ATOM	3317	CA	ASN	A	462	99.779	83.611	39.733	1.00	30.16	C
ATOM	3318	C	ASN	A	462	98.589	83.674	38.774	1.00	29.60	C
ATOM	3319	O	ASN	A	462	97.568	84.282	39.107	1.00	30.16	O
ATOM	3320	CB	ASN	A	462	100.683	84.817	39.484	1.00	31.63	C
ATOM	3321	CG	ASN	A	462	101.759	84.960	40.543	1.00	32.75	C
ATOM	3322	OD1	ASN	A	462	102.725	85.696	40.367	1.00	35.69	O
ATOM	3323	ND2	ASN	A	462	101.588	84.262	41.656	1.00	31.98	N
ATOM	3324	N	ALA	A	463	98.711	83.066	37.598	1.00	27.52	N
ATOM	3325	CA	ALA	A	463	97.634	83.103	36.610	1.00	26.51	C
ATOM	3326	C	ALA	A	463	96.338	82.451	37.076	1.00	25.73	C
ATOM	3327	O	ALA	A	463	96.348	81.386	37.679	1.00	25.89	O
ATOM	3328	CB	ALA	A	463	98.096	82.465	35.313	1.00	24.91	C
ATOM	3329	N	GLN	A	464	95.222	83.113	36.785	1.00	25.80	N
ATOM	3330	CA	GLN	A	464	93.888	82.619	37.136	1.00	25.60	C
ATOM	3331	C	GLN	A	464	92.959	82.601	35.923	1.00	24.30	C
ATOM	3332	C	GLN	A	464	93.147	83.369	34.977	1.00	23.88	O
ATOM	3333	CB	GLN	A	464	93.270	83.492	38.214	1.00	25.18	C
ATOM	3334	CG	GLN	A	464	93.996	83.413	39.517	1.00	28.22	C
ATOM	3335	CD	GLN	A	464	93.378	84.314	40.545	1.00	29.41	C
ATOM	3336	OE1	GLN	A	464	93.378	85.539	40.395	1.00	30.21	O
ATOM	3337	NE2	GLN	A	464	92.829	83.716	41.596	1.00	30.03	N
ATOM	3338	N	PHE	A	465	91.962	81.721	35.959	1.00	22.93	N
ATOM	3339	CA	PHE	A	465	91.009	81.614	34.868	1.00	22.72	C
ATOM	3340	C	PHE	A	465	89.627	82.121	35.246	1.00	23.14	C
ATOM	3341	O	PHE	A	465	89.199	82.035	36.404	1.00	23.64	O
ATOM	3342	CB	PHE	A	465	90.820	80.162	34.415	1.00	22.18	C
ATOM	3343	CG	PHE	A	465	92.042	79.513	33.836	1.00	23.68	C
ATOM	3344	CD1	PHE	A	465	92.775	78.594	34.577	1.00	25.25	C
ATOM	3345	CD2	PHE	A	465	92.437	79.780	32.533	1.00	23.42	C
ATOM	3346	CE1	PHE	A	465	93.884	77.947	34.025	1.00	24.49	C
ATOM	3347	CE2	PHE	A	465	93.544	79.138	31.974	1.00	23.33	C
ATOM	3348	CZ	PHE	A	465	94.265	78.220	32.724	1.00	24.38	C
ATOM	3349	N	VAL	A	466	88.932	82.656	34.251	1.00	22.63	N
ATOM	3350	CA	VAL	A	466	87.556	83.094	34.415	1.00	21.20	C
ATOM	3351	C	VAL	A	466	86.828	82.188	33.423	1.00	21.50	C
ATOM	3352	O	VAL	A	466	87.281	81.994	32.300	1.00	19.95	O
ATOM	3353	CB	VAL	A	466	87.352	84.586	34.061	1.00	19.34	C
ATOM	3354	CG1	VAL	A	466	87.897	84.887	32.698	1.00	18.84	C
ATOM	3355	CG2	VAL	A	466	85.872	84.924	34.123	1.00	18.58	C
ATOM	3356	N	GLU	A	467	85.726	81.601	33.854	1.00	22.06	N
ATOM	3357	CA	GLU	A	467	84.979	80.698	33.005	1.00	24.06	C
ATOM	3358	C	GLU	A	467	84.050	81.439	32.068	1.00	24.75	C
ATOM	3359	O	GLU	A	467	83.415	82.413	32.465	1.00	25.25	O
ATOM	3360	CB	GLU	A	467	84.151	79.763	33.858	1.00	24.21	C
ATOM	3361	CG	GLU	A	467	83.546	78.653	33.077	1.00	28.44	C

-continued

ATOM	3362	CD	GLU	A	467	82.524	77.934	33.879	1.00	32.19	C
ATOM	3363	OE1	GLU	A	467	82.756	77.771	35.093	1.00	34.37	O
ATOM	3364	OE2	GLU	A	467	81.502	77.521	33.298	1.00	35.05	O
HETATM	3365	N	MSE	A	468	83.956	80.981	30.826	1.00	24.94	N
HETATM	3366	CA	MSE	A	468	83.066	81.631	29.878	1.00	26.54	C
HETATM	3367	C	MSE	A	468	82.086	80.645	29.274	1.00	26.74	C
HETATM	3368	O	MSE	A	468	82.353	79.444	29.218	1.00	26.45	O
HETATM	3369	CB	MSE	A	468	83.858	82.322	28.763	1.00	28.88	C
HETATM	3370	CG	MSE	A	468	84.730	81.421	27.918	1.00	31.63	C
HETATM	3371	SE	MSE	A	468	85.425	82.387	26.542	1.00	39.89	SE
HETATM	3372	CE	MSE	A	468	86.595	81.206	25.795	1.00	34.18	C
ATOM	3373	N	SER	A	469	80.945	81.156	28.827	1.00	27.65	N
ATOM	3374	CA	SER	A	469	79.919	80.314	28.212	1.00	28.52	C
ATOM	3375	C	SER	A	469	80.148	80.275	26.705	1.00	29.26	C
ATOM	3376	O	SER	A	469	81.093	80.886	26.197	1.00	28.60	O
ATOM	3377	CB	SER	A	469	78.532	80.888	28.488	1.00	27.30	C
ATOM	3378	OG	SER	A	469	78.385	82.148	27.847	1.00	27.56	O
ATOM	3379	N	GLY	A	470	79.271	79.566	25.996	1.00	31.42	N
ATOM	3380	CA	GLY	A	470	79.384	79.479	24.549	1.00	33.33	C
ATOM	3381	C	GLY	A	470	79.362	80.860	23.920	1.00	35.22	C
ATOM	3382	O	GLY	A	470	80.083	81.131	22.956	1.00	36.54	O
ATOM	3383	N	ALA	A	471	78.530	81.738	24.477	1.00	35.45	N
ATOM	3384	CA	ALA	A	471	78.408	83.106	23.992	1.00	36.13	C
ATOM	3385	C	ALA	A	471	79.720	83.867	24.206	1.00	36.97	C
ATOM	3386	O	ALA	A	471	80.182	84.595	23.321	1.00	37.26	O
ATOM	3387	CB	ALA	A	471	77.268	83.809	24.722	1.00	35.98	C
ATOM	3388	N	GLY	A	472	80.311	83.701	25.388	1.00	37.72	N
ATOM	3389	CA	GLY	A	472	81.565	84.369	25.691	1.00	38.01	C
ATOM	3390	C	GLY	A	472	82.656	83.924	24.730	1.00	38.54	C
ATOM	3391	O	GLY	A	472	83.558	84.695	24.385	1.00	38.01	O
ATOM	3392	N	LEU	A	473	82.573	82.667	24.296	1.00	38.34	N
ATOM	3393	CA	LEU	A	473	83.550	82.125	23.363	1.00	37.79	C
ATOM	3394	C	LEU	A	473	83.349	82.890	22.050	1.00	37.07	C
ATOM	3395	O	LEU	A	473	84.316	83.285	21.395	1.00	36.58	O
ATOM	3396	CB	LEU	A	473	83.306	80.624	23.152	1.00	38.74	C
ATOM	3397	CG	LEU	A	473	84.497	79.733	22.761	1.00	39.23	C
ATOM	3398	CD1	LEU	A	473	83.986	78.347	22.459	1.00	38.60	C
ATOM	3399	CD2	LEU	A	473	85.229	80.274	21.558	1.00	40.46	C
ATOM	3400	N	ILE	A	474	82.084	83.108	21.687	1.00	36.82	N
ATOM	3401	CA	ILE	A	474	81.737	83.841	20.463	1.00	36.70	C
ATOM	3402	C	ILE	A	474	82.348	85.238	20.536	1.00	36.56	C
ATOM	3403	O	ILE	A	474	82.968	85.707	19.582	1.00	36.03	O
ATOM	3404	CB	ILE	A	474	80.198	84.001	20.294	1.00	36.35	C
ATOM	3405	CG1	ILE	A	474	79.516	82.630	20.276	1.00	36.33	C
ATOM	3406	CG2	ILE	A	474	79.889	84.760	19.006	1.00	35.09	C
ATOM	3407	CD1	ILE	A	474	79.989	81.719	19.171	1.00	35.80	C
ATOM	3408	N	GLU	A	475	82.159	85.899	21.674	1.00	35.95	&
ATOM	3409	CA	GLU	A	475	82.700	87.233	21.880	1.00	36.17	C
ATOM	3410	C	GLU	A	475	84.216	87.235	21.791	1.00	36.53	C
ATOM	3411	O	GLU	A	475	84.807	88.209	21.327	1.00	36.42	O
ATOM	3412	CB	GLU	A	475	82.263	87.776	23.254	1.00	37.61	C
ATOM	3413	CG	GLU	A	475	83.143	88.914	23.827	1.00	37.08	C
ATOM	3414	CD	GLU	A	475	82.626	89.458	25.164	1.00	37.58	C
ATOM	3415	OE1	GLU	A	475	81.614	90.188	25.161	1.00	38.57	O
ATOM	2416	OE2	GLU	A	475	83.216	89.146	26.221	1.00	33.85	O
ATOM	2417	N	SER	A	476	84.841	86.145	22.237	1.00	37.04	N
ATOM	2418	CA	SER	A	476	86.300	86.039	22.242	1.00	37.27	C
ATOM	2419	C	SER	A	476	86.924	85.973	20.851	1.00	37.06	C
ATOM	2420	O	SER	A	476	88.046	86.442	20.638	1.00	37.30	O
ATOM	3421	CB	SER	A	476	86.728	84.830	23.068	1.00	36.80	C
ATOM	3422	OG	SER	A	476	86.251	84.963	24.391	1.00	36.30	O
ATOM	3423	N	HIS	A	477	86.197	85.391	19.908	1.00	36.25	N
ATOM	3424	CA	HIS	A	477	86.667	85.288	18.533	1.00	36.22	C
ATOM	3425	C	HIS	A	477	86.181	86.477	17.724	1.00	36.09	C
ATOM	3426	O	HIS	A	477	85.207	87.141	18.100	1.00	34.72	O
ATOM	3427	CB	HIS	A	477	86.132	84.008	17.897	1.00	36.36	C
ATOM	3428	CG	HIS	A	477	86.901	82.789	18.267	1.00	36.15	C
ATOM	3429	ND1	HIS	A	477	88.077	82.440	17.644	1.00	37.86	N
ATOM	3430	CD2	HIS	A	477	86.690	81.858	19.224	1.00	37.82	C
ATOM	3431	CE1	HIS	A	477	88.559	81.343	18.200	1.00	38.68	C
ATOM	3432	NE2	HIS	A	477	87.736	80.969	19.162	1.00	38.42	N
ATOM	3433	N	PRO	A	478	86.865	86.778	16.606	1.00	36.62	N
ATOM	3434	CA	PRO	A	478	86.409	87.910	15.801	1.00	37.52	C
ATOM	3435	C	PRO	A	478	84.974	87.589	15.387	1.00	38.47	C
ATOM	3436	O	PRO	A	478	84.626	86.417	15.192	1.00	37.19	O
ATOM	3437	CB	PRO	A	478	87.391	87.901	14.624	1.00	36.75	C
ATOM	3438	CG	PRO	A	478	88.651	87.370	15.266	1.00	36.00	C
ATOM	3439	CD	PRO	A	478	88.056	86.173	15.987	1.00	36.59	C
ATOM	3440	N	RIS	A	479	84.141	88.617	15.271	1.00	40.10	N

-continued

ATOM	3441	CA	HIS	A	479	82.749	88.409	14.898	1.00	41.71	C
ATOM	3442	C	HIS	A	479	82.163	89.607	14.178	1.00	43.00	C
ATOM	3443	O	HIS	A	479	82.691	90.723	14.263	1.00	42.96	O
ATOM	3444	CB	HIS	A	479	81.906	88.138	16.142	1.00	42.19	C
ATOM	3445	CG	HIS	A	479	82.004	89.217	17.175	1.00	42.96	C
ATOM	3446	ND1	HIS	A	479	83.105	89.373	17.989	1.00	44.02	N
ATOM	3447	CD2	HIS	A	479	81.154	90.221	17.499	1.00	44.12	C
ATOM	3448	CE1	HIS	A	479	82.929	90.423	18.773	1.00	43.65	C
ATOM	3449	NE2	HIS	A	479	81.753	90.956	18.495	1.00	44.04	N
ATOM	3450	N	ASP	A	480	81.055	89.355	13.482	1.00	44.35	N
ATOM	3451	CA	ASP	A	480	80.321	90.373	12.741	1.00	45.86	C
ATOM	3452	C	ASP	A	480	81.196	91.161	11.787	1.00	45.95	C
ATOM	3453	O	ASP	A	480	81.074	92.381	11.676	1.00	46.64	O
ATOM	3454	CB	ASP	A	480	79.631	91.326	13.716	1.00	47.55	C
ATOM	3455	CG	ASP	A	480	78.698	90.601	14.672	1.00	50.07	C
ATOM	3456	OD1	ASP	A	480	77.750	89.935	14.191	1.00	50.68	O
ATOM	3457	OD2	ASP	A	480	78.912	90.698	15.904	1.00	52.11	O
ATOM	3458	N	VAL	A	481	82.083	90.457	11.099	1.00	46.00	N
ATOM	3459	CA	VAL	A	481	82.975	91.093	10.141	1.00	45.97	C
ATOM	3460	C	VAL	A	481	83.437	90.069	9.105	1.00	45.58	C
ATOM	3461	O	VAL	A	481	83.781	88.934	9.438	1.00	44.87	O
ATOM	3462	CB	VAL	A	481	84.199	91.748	10.861	1.00	46.24	C
ATOM	3463	CG1	VAL	A	481	84.888	90.733	11.769	1.00	46.53	C
ATOM	3464	CG2	VAL	A	481	85.177	92.301	9.834	1.00	45.43	C
ATOM	3465	N	GLN	A	482	83.416	90.475	7.842	1.00	45.62	N
ATOM	3466	CA	GLN	A	482	83.822	89.600	6.756	1.00	45.66	C
ATOM	3467	C	GLN	A	482	85.331	89.650	6.600	1.00	45.00	C
ATOM	3468	O	GLN	A	482	85.898	90.706	6.353	1.00	44.56	O
ATOM	3469	CB	GLN	A	482	83.129	90.035	5.466	1.00	46.54	C
ATOM	3470	CG	GLN	A	482	83.384	89.130	4.279	1.00	49.29	C
ATOM	3471	CD	GLN	A	482	82.506	89.489	3.095	1.00	51.02	C
ATOM	3472	OE1	GLN	A	482	81.280	89.447	3.190	1.00	53.04	O
ATOM	3473	NE2	GLN	A	482	83.126	89.847	1.976	1.00	50.81	N
ATOM	3474	N	ILE	A	483	85.977	88.500	6.760	1.00	45.70	N
ATOM	3475	CA	ILE	A	483	87.431	88.406	6.643	1.00	46.40	C
ATOM	3476	C	ILE	A	483	87.797	87.626	5.378	1.00	46.80	C
ATOM	3477	O	ILE	A	483	87.378	86.479	5.209	1.00	47.10	O
ATOM	3478	CB	ILE	A	483	88.045	87.668	7.870	1.00	46.86	C
ATOM	3479	CG1	ILE	A	483	87.565	88.314	9.172	1.00	47.22	C
ATOM	3480	CG2	ILE	A	483	89.566	87.721	7.804	1.00	46.15	C
ATOM	3481	CD1	ILE	A	483	88.107	87.641	10.430	1.00	47.26	C
ATOM	3482	N	THR	A	484	88.573	88.240	4.491	1.00	47.02	N
ATOM	3483	CA	THR	A	484	88.970	87.565	3.258	1.00	47.69	C
ATOM	3484	C	THR	A	484	90.448	87.182	3.316	1.00	47.46	C
ATOM	3485	O	THR	A	484	90.908	86.296	2.599	1.00	46.97	O
ATOM	3486	CB	THR	A	484	88.710	98.453	2.002	1.00	48.12	C
ATOM	3487	CG1	THR	A	484	89.451	89.676	2.114	1.00	49.12	O
ATOM	3488	CG2	THR	A	484	87.219	88.767	1.861	1.00	47.18	C
ATOM	3489	N	ASN	A	485	91.184	87.894	4.171	1.00	47.14	N
ATOM	3490	CA	ASN	A	485	92.605	87.644	4.356	1.00	47.75	C
ATOM	3491	C	ASN	A	485	92.864	87.515	5.854	1.00	47.58	C
ATOM	3492	O	ASN	A	485	92.851	88.507	6.594	1.00	47.74	O
ATOM	3493	CB	ASN	A	485	93.436	88.785	3.767	1.00	48.75	C
ATOM	3494	CG	ASN	A	485	94.934	88.540	3.890	1.00	50.65	C
ATOM	3495	OD1	ASN	A	485	95.453	87.518	3.429	1.00	50.94	O
ATOM	3496	ND2	ASN	A	485	95.636	89.483	4.508	1.00	51.72	N
ATOM	3497	N	GLU	A	486	93.099	86.276	6.281	1.00	46.65	N
ATOM	3498	CA	GLU	A	486	93.332	85.930	7.680	1.00	45.73	C
ATOM	3499	C	GLU	A	486	94.720	86.252	8.207	1.00	45.11	C
ATOM	3500	O	GLU	A	486	95.660	86.465	7.443	1.00	45.20	O
ATOM	3501	CB	GLU	A	486	93.057	84.441	7.867	1.00	46.18	C
ATOM	3502	CG	GLU	A	486	91.649	84.047	7.462	1.00	46.84	C
ATOM	3503	CD	GLU	A	486	91.503	82.556	7.259	1.00	47.48	C
ATOM	3504	OE1	GLU	A	486	90.380	82.105	6.946	1.00	47.47	O
ATOM	3505	OE2	GLU	A	486	92.518	81.838	7.402	1.00	47.64	O
ATOM	3506	N	ALA	A	487	94.835	86.284	9.530	1.00	44.77	N
ATOM	3507	CA	ALA	A	487	96.106	86.563	10.187	1.00	44.41	C
ATOM	3508	C	ALA	A	487	96.892	85.264	10.290	1.00	44.54	C
ATOM	3509	O	ALA	A	487	96.314	84.184	10.407	1.00	43.71	O
ATOM	3510	CB	ALA	A	487	95.867	87.143	11.563	1.00	44.17	C
ATOM	3511	N	PRO	A	488	98.227	85.350	10.227	1.00	45.67	N
ATOM	3512	CA	PRO	A	488	99.083	84.168	10.317	1.00	46.18	C
ATOM	3513	C	PRO	A	488	98.978	83.485	11.675	1.00	46.38	C
ATOM	3514	O	PRO	A	488	99.572	82.434	11.892	1.00	47.49	O
ATOM	3515	CB	PRO	A	488	100.474	84.751	10.064	1.00	46.01	C
ATOM	3516	CG	PRO	A	488	100.351	66.122	10.696	1.00	46.03	C
ATOM	3517	CD	PRO	A	488	99.059	86.551	10.034	1.00	46.59	C
ATOM	3518	N	ASN	A	489	98.218	84.075	12.587	1.00	46.12	N
ATOM	3519	CA	ASN	A	489	98.073	83.499	13.918	1.00	46.19	C

-continued

ATOM	3520	C	ASN	A	489	96.604	83.237	14.261	1.00	45.99	C
ATOM	3521	O	ASN	A	489	96.258	82.970	15.415	1.00	45.30	O
ATOM	3522	CB	ASN	A	489	98.712	84.433	14.948	1.00	45.82	C
ATOM	3523	CG	ASN	A	489	97.953	85.736	15.101	1.00	47.05	C
ATOM	3524	OD1	ASN	A	489	97.335	86.229	14.152	1.00	47.80	O
ATOM	3525	ND2	ASN	A	489	98.019	86.320	16.293	1.00	47.88	N
ATOM	3526	N	TYR	A	490	95.741	83.327	13.253	1.00	45.80	N
ATOM	3527	CA	TYR	A	490	94.319	83.069	13.447	1.00	45.86	C
ATOM	3528	C	TYR	A	490	93.669	82.536	12.168	1.00	46.13	C
ATOM	3529	C	TYR	A	490	93.361	83.295	11.246	1.00	45.86	O
ATOM	3530	CB	TYR	A	490	93.576	84.328	13.916	1.00	44.08	C
ATOM	3531	CG	TYR	A	490	92.148	84.013	14.302	1.00	42.82	C
ATOM	3532	CD1	TYR	A	490	91.871	83.222	15.419	1.00	41.48	C
ATOM	3533	CD2	TYR	A	490	91.080	84.402	13.489	1.00	42.13	C
ATOM	3534	CE1	TYR	A	490	90.570	82.816	15.709	1.00	41.83	C
ATOM	3535	CE2	TYR	A	490	89.776	84.001	13.772	1.00	41.77	C
ATOM	3536	CZ	TYR	A	490	89.529	83.204	14.881	1.00	41.35	C
ATOM	3537	OH	TYR	A	490	88.248	82.771	15.141	1.00	40.05	O
ATOM	3536	N	SER	A	491	93.475	81.220	12.135	1.00	47.86	N
ATOM	3539	CA	SER	A	491	92.880	80.512	11.005	1.00	49.91	C
ATOM	3540	C	SER	A	491	93.583	80.739	9.661	1.00	51.25	C
ATOM	3541	O	SER	A	491	94.408	81.674	9.551	1.00	53.12	O
ATOM	3542	CB	SER	A	491	91.402	80.881	10.887	1.00	50.03	C
ATOM	3543	OG	SER	A	491	90.700	80.462	12.043	1.00	51.19	O
ATOM	3544	N	VAL	A	492	93.288	79.975	8.714	1.00	52.00	N
TER	3545		VAL	A	492						
HETATM	3546	P	IMP		500	96.855	67.484	18.145	1.00	36.20	P
HETATM	3547	O1P	IMP		500	96.567	66.958	16.764	1.00	35.78	O
HETATM	3548	O2P	IMP		500	97.831	68.643	18.107	1.00	37.27	O
HETATM	3549	O3P	IMP		500	95.630	67.848	18.926	1.00	37.73	O
HETATM	3550	O5*	IMP		500	97.576	66.348	19.098	1.00	39.55	C
HETATM	3551	C5*	IMP		500	96.906	65.102	19.379	1.00	43.52	C
HETATM	3552	C4*	IMP		500	97.725	64.188	20.314	1.00	46.38	C
HETATM	3553	O4*	IMP		500	96.849	63.056	20.510	1.00	47.93	O
HETATM	3554	C3*	IMP		500	99.128	63.615	19.896	1.00	47.80	C
HETATM	3555	O3*	IMP		500	100.283	64.165	20.566	1.00	48.27	O
HETATM	3556	C2*	IMP		500	99.063	62.138	20.401	1.00	48.14	C
HETATM	3557	O2*	IMP		500	99.459	61.962	21.777	1.00	47.86	O
HETATM	3558	C1*	IMP		500	97.568	61.820	20.391	1.00	48.84	C
HETATM	3559	N9	IMP		500	97.172	60.952	19.187	1.00	49.35	N
HETATM	3560	C8	IMP		500	97.769	60.762	17.934	1.00	49.94	C
HETATM	3561	N7	IMP		500	96.960	59.811	17.195	1.00	49.47	N
HETATM	3562	C5	IMP		500	95.903	59.489	18.092	1.00	49.72	C
HETATM	3563	C6	IMP		500	94.774	58.548	17.851	1.00	49.49	C
HETATM	3564	O6	IMP		500	94.520	57.868	16.852	1.00	49.17	O
HETATM	3565	N1	IMP		500	93.959	58.521	15.994	1.00	50.36	N
HETATM	3566	C2	IMP		500	94.155	59.256	20.190	1.00	50.39	C
HETATM	3567	N3	IMP		500	95.182	60.067	20.313	1.00	49.12	N
HETATM	3568	C4	IMP		500	96.016	60.150	19.259	1.00	49.43	C
HETATM	3569	O	HOH		501	100.576	78.275	17.774	1.00	32.86	O
HETATM	3570	O	HOH		503	91.095	64.490	36.206	1.00	28.90	O
HETATM	3571	O	HOH		504	94.498	58.629	33.377	1.00	29.01	O
HETATM	3572	O	HOH		505	121.994	54.382	32.283	1.00	29.34	O
HETATM	3573	O	HOH		506	103.325	52.600	39.850	1.00	30.92	O
HETATM	3574	O	HOH		506	114.082	79.200	14.020	1.00	31.09	O
HETATM	3575	O	HOH		509	111.782	75.357	9.474	1.00	41.74	O
HETATM	3576	O	HOH		510	130.431	69.550	6.520	1.00	33.07	O
HETATM	3577	O	HOH		511	139.704	72.872	5.502	1.00	28.29	O
HETATM	3578	O	HOH		512	138.165	79.843	7.558	1.00	37.74	O
HETATM	3579	O	HOH		513	110.012	65.496	9.942	1.00	27.19	O
HETATM	3580	O	HOH		514	95.709	85.791	36.220	1.00	26.84	O
HETATM	3581	O	HOH		515	97.359	70.230	25.703	1.00	26.44	O
HETATM	3582	O	HOH		516	111.343	65.984	36.009	1.00	27.68	O
HETATM	3583	O	HOH		517	92.610	64.734	28.562	1.00	25.19	O
HETATM	3584	O	HOH		518	136.337	83.402	18.230	1.00	44.74	O
HETATM	3585	O	HOH		519	125.872	72.828	24.786	1.00	56.58	O
HETATM	3586	O	HOH		520	123.394	85.143	17.982	1.00	44.83	O
HETATM	3587	O	HOH		521	114.051	75.607	10.822	1.00	28.33	O
HETATM	3588	O	HOH		522	95.439	56.751	21.398	1.00	35.18	O
HETATM	3589	O	HOH		523	126.131	73.771	18.625	1.00	28.52	O
HETATM	3590	O	HOH		524	88.573	61.550	21.356	1.00	35.43	O
HETATM	3591	O	HOH		525	84.159	71.151	29.206	1.00	24.40	O
HETATM	3592	O	HOH		526	133.284	55.863	10.735	1.00	36.12	O
HETATM	3593	O	HOH		527	127.221	75.361	20.788	1.00	31.12	O
HETATM	3594	O	HOH		528	144.500	73.437	21.138	1.00	37.89	O
HETATM	3595	O	HOH		529	104.651	89.119	21.108	1.00	45.21	O
HETATM	3596	O	HOH		530	97.113	80.827	16.767	1.00	29.31	O
HETATM	3597	O	HOH		531	115.587	76.287	34.279	1.00	41.57	O
HETATM	3598	O	HOH		532	110.085	78.952	34.960	1.00	36.98	O

-continued

HETATM	3599	O	HOH	533	113.576	64.235	37.324	1.00	44.04	O
HETATM	3600	O	HOH	536	113.308	82.910	26.870	1.00	35.47	O
HETATM	3601	O	HOH	537	135.913	65.420	20.988	1.00	42.04	O
HETATM	3602	O	HOH	538	81.878	61.168	23.889	1.00	37.18	O
HETATM	3603	O	HOH	539	112.973	80.799	18.829	1.00	46.80	O
HETATM	3604	O	HOH	540	114.422	67.736	18.471	1.00	21.38	O
HETATM	3605	O	HOH	541	149.015	73.669	7.625	1.00	31.27	O
HETATM	3606	O	HOH	542	94.881	66.686	41.661	1.00	28.69	O
HETATM	3607	O	HOH	544	100.410	54.930	42.976	1.00	40.88	O
HETATM	3608	O	HOH	546	123.513	59.702	10.409	1.00	32.15	O
HETATM	3609	O	HOH	547	146.434	72.633	24.076	1.00	36.35	O
HETATM	3610	O	HOH	548	88.886	71.737	36.970	1.00	30.08	O
HETATM	3611	O	HOH	549	107.710	87.920	18.571	1.00	46.77	O
HETATM	3612	O	HOH	550	89.670	63.104	37.776	1.00	47.36	O
HETATM	3613	O	HOH	552	122.692	77.602	19.074	1.00	36.80	O
HETATM	3614	O	HOH	553	98.993	52.226	5.651	1.00	57.87	O
HETATM	3615	O	HOH	554	113.536	82.903	22.647	1.00	41.61	O
HETATM	3616	O	HOH	555	115.587	74.041	10.297	1.00	38.20	O
HETATM	3617	O	HOH	557	98.458	49.507	39.120	1.00	62.44	O
HETATM	3618	O	HOH	558	112.138	63.863	8.254	1.00	24.96	O
HETATM	3619	O	HOH	560	118.847	70.191	28.617	1.00	45.38	O
HETATM	3620	O	HOH	561	146.469	68.284	24.114	1.00	37.59	O
HETATM	3621	O	HOH	562	128.262	63.501	17.485	1.00	38.06	O
HETATM	3622	O	HOH	563	119.639	64.695	7.607	1.00	46.90	O
HETATM	3623	O	HOH	564	103.490	70.881	36.574	1.00	31.68	O
HETATM	3624	O	HOH	565	98.314	86.799	37.005	1.00	30.76	O
HETATM	3625	O	HOH	567	131.484	71.418	23.548	1.00	36.31	O
HETATM	3626	O	HOH	568	76.343	60.795	41.874	1.00	35.52	O
HETATM	3627	O	HOH	569	126.027	59.075	12.269	1.00	43.45	O
HETATM	3628	O	HOH	570	109.042	74.363	33.675	1.00	39.31	O
HETATM	3629	O	HOM	573	80.409	90.280	22.579	1.00	34.21	O
HETATM	3630	O	HOH	574	132.441	66.786	9.212	1.00	43.87	O
HETATM	3631	O	HOH	575	109.944	79.697	32.230	1.00	32.32	O
HETATM	3632	O	HOH	577	144.216	66.858	24.156	1.00	40.46	O
HETATM	3633	O	HOH	578	129.414	81.484	16.530	1.00	61.51	O
HETATM	3634	O	HOH	579	96.972	92.020	39.467	1.00	39.03	O
HETATM	3635	O	HOH	580	94.372	70.562	18.189	1.00	26.74	O
HETATM	3636	O	HOH	581	88.506	73.637	23.695	1.00	31.00	O
HETATM	3637	O	HOH	584	100.007	84.003	17.987	1.00	28.74	O
HETATM	3638	O	HOH	585	121.405	52.600	17.537	1.00	40.20	O
HETATM	3639	O	HOH	588	119.167	48.434	16.339	1.00	65.21	O
HETATM	3640	O	HOH	589	102.348	55.052	4.902	1.00	39.64	O
HETATM	3641	O	HOH	595	97.908	70.027	21.031	1.00	34.06	O
HETATM	3642	O	HOH	596	146.572	53.248	20.725	1.00	45.62	O
HETATM	3643	O	HOH	598	90.443	55.094	8.608	1.00	49.49	O
HETATM	3644	O	HOH	599	109.411	77.677	2.747	1.00	53.11	O
HETATM	3645	O	HOH	600	107.764	45.882	37.351	1.00	45.02	O
HETATM	3646	O	HOH	601	87.454	73.205	28.703	1.00	45.44	O
HETATM	3647	O	HOH	602	80.069	88.678	20.249	1.00	42.72	O
HETATM	3648	O	HOH	603	117.159	79.599	17.309	1.00	30.98	O
HETATM	3649	O	HOH	604	84.446	85.847	6.609	1.00	66.35	O
HETATM	3650	O	HOH	605	142.262	74.880	21.888	1.00	42.69	O
HETATM	3651	O	HOH	606	133.945	64.662	5.678	1.00	39.03	O
HETATM	3652	O	HOH	607	110.322	88.556	20.860	1.00	51.80	O
HETATM	3653	O	HOH	608	118.514	60.464	29.384	1.00	33.39	O
HETATM	3654	O	HOH	609	82.950	78.301	25.302	1.00	33.55	O
HETATM	3655	O	HOH	610	111.407	75.421	34.632	1.00	44.58	O
HETATM	3656	O	HOH	612	96.558	63.438	23.644	1.00	34.09	O
HETATM	3657	O	HOH	613	122.627	63.063	23.597	1.00	26.90	O
HETATM	3658	O	HOH	614	131.169	69.077	14.358	1.00	34.02	O
HETATM	3659	O	HOH	618	96.690	54.179	40.860	1.00	32.89	O
HETATM	3660	O	HOH	619	126.711	73.763	15.905	1.00	32.41	O
HETATM	3661	O	HOH	621	92.253	63.599	39.103	1.00	25.94	O
HETATM	3662	O	HOH	622	97.813	87.700	39.424	1.00	55.96	O
HETATM	3663	O	HOH	623	95.535	56.002	20.767	1.00	65.87	O
HETATM	3664	O	HOH	624	129.489	78.975	20.616	1.00	46.43	O
HETATM	3665	O	HOH	625	119.866	48.017	8.457	1.00	69.76	O
HETATM	3666	O	HOH	627	134.345	53.135	10.168	1.00	47.96	O
HETATM	3667	O	HOH	628	96.130	73.007	12.133	1.00	65.41	O
HETATM	3668	O	HOH	629	87.800	55.819	15.251	1.00	45.94	O
HETATM	3669	O	HOH	630	112.422	70.233	37.715	1.00	55.93	O
HETATM	3670	O	HOH	632	121.366	74.739	24.939	1.00	57.43	O
HETATM	3671	O	HOH	633	101.115	80.540	12.424	1.00	53.67	O
HETATM	3672	O	HOH	634	124.882	64.152	26.715	1.00	65.56	O
HETATM	3673	O	HOH	635	97.480	87.029	5.748	1.00	41.53	O
HETATM	3674	O	HOH	636	98.153	71.085	17.480	1.00	23.05	O
HETATM	3675	O	HOH	638	109.916	53.593	7.340	1.00	60.03	O
HETATM	3676	O	HOH	639	109.356	46.219	43.098	1.00	74.41	O
HETATM	3677	O	HOH	640	123.090	65.562	2.087	1.00	64.16	O

-continued

HETATM	3678	O	HOH	641	121.091	58.113	37.981	1.00	53.09	O
HETATM	3679	O	HOH	642	106.879	71.024	39.823	1.00	49.73	O
HETATM	3680	O	HOH	644	125.842	60.086	22.102	1.00	57.75	O
HETATM	3681	O	HOH	645	89.792	80.261	21.919	1.00	65.49	O
HETATM	3682	O	HOH	646	127.581	71.494	10.877	1.00	41.56	O
HETATM	3683	O	HOH	647	116.711	52.692	38.666	1.00	55.88	O
HETATM	3684	O	HOH	648	137.352	49.806	16.559	1.00	67.37	O
HETATM	3685	O	HOH	649	93.707	89.594	38.028	1.00	28.70	O
HETATM	3686	O	HOH	650	102.722	58.313	7.082	1.00	52.26	O
HETATM	3687	O	HOH	651	99.494	73.756	-9.807	1.00	57.10	O
HETATM	3688	O	HOH	652	100.369	60.404	12.181	1.00	24.56	O
HETATM	3689	O	HOH	653	86.387	73.114	22.271	1.00	36.14	O
HETATM	3690	O	HOH	655	82.774	85.056	16.980	1.00	29.50	O
HETATM	3691	O	HOH	656	138.719	75.750	24.731	1.00	43.44	O
HETATM	3692	O	HOH	657	135.443	63.373	23.553	1.00	62.79	O
HETATM	3693	O	HOH	658	136.532	59.341	22.164	1.00	61.51	O
HETATM	3694	O	HOH	659	112.228	46.754	14.166	1.00	44.56	O
HETATM	3695	O	HOH	661	85.056	77.737	37.011	1.00	51.97	O
HETATM	3696	O	HOH	664	93.862	94.123	24.058	1.00	44.59	O
HETATM	3697	O	HOH	665	125.115	50.268	16.057	1.00	50.48	O
HETATM	3698	O	HOH	666	109.792	82.218	39.304	1.00	41.41	O
HETATM	3699	O	HOH	667	81.419	71.538	32.800	1.00	43.84	O
HETATM	3700	O	HOH	671	100.872	91.979	23.613	1.00	64.05	O
HETATM	3701	O	HOH	672	121.924	64.730	9.693	1.00	40.99	O
HETATM	3702	O	HOH	673	103.164	53.450	45.794	1.00	46.76	O
HETATM	3703	O	HOH	674	112.887	44.758	35.892	1.00	60.15	O
HETATM	3704	O	HOH	675	121.226	52.298	40.410	1.00	59.96	O
HETATM	3705	O	HOH	676	114.778	79.883	12.588	1.00	53.72	O
HETATM	3706	O	HOH	677	111.493	44.375	26.336	1.00	44.91	O
HETATM	3707	O	HOH	680	125.672	77.196	7.641	1.00	62.63	O
HETATM	3708	O	HOH	681	149.427	68.734	21.594	1.00	69.45	O
HETATM	3709	O	HOH	682	130.498	68.890	11.409	1.00	43.07	O
HETATM	3710	O	HOH	684	97.027	74.301	-8.091	1.00	51.74	O
HETATM	3711	O	HOH	685	93.468	57.644	35.310	1.00	25.70	O
HETATM	3712	O	HOH	687	120.082	63.118	33.794	1.00	66.97	O
HETATM	3713	O	HOH	688	91.794	50.180	5.365	1.00	61.88	O
HETATM	3714	O	HOH	691	120.955	66.509	26.956	1.00	57.92	O
HETATM	3715	O	HOH	692	147.976	65.172	14.279	1.00	58.48	O
HETATM	3716	O	HOH	693	90.415	78.310	23.880	1.00	38.31	O
HETATM	3717	O	HOH	694	113.372	43.333	17.881	1.00	68.93	O
HETATM	3718	O	HOH	695	101.223	90.113	38.606	1.00	45.49	O
HETATM	3719	O	HOH	696	108.151	50.895	41.168	1.00	59.49	O
HETATM	3720	O	HOH	697	90.431	44.244	14.620	1.00	43.55	O
HETATM	3721	O	HOH	698	146.554	70.443	18.977	1.00	32.63	O
HETATM	3722	O	HOH	702	107.324	89.479	37.117	1.00	65.35	O
HETATM	3723	O	HOH	706	181.406	55.047	15.937	1.00	56.70	C
HETATM	3724	O	HOH	707	101.778	67.697	-5.655	1.00	34.92	O
HETATM	3725	O	HOH	709	136.699	62.881	-10.241	1.00	53.86	O
HETATM	3726	O	HOH	710	115.523	70.686	9.393	1.00	35.01	O
HETATM	3727	O	HOH	714	140.987	80.163	24.272	1.00	65.37	O
HETATM	3728	O	HOH	715	144.845	70.181	8.359	1.00	45.96	O
HETATM	3729	O	HOH	716	127.420	64.712	10.814	1.00	50.93	O
HETATM	3730	O	HbH	717	112.586	85.955	35.733	1.00	63.37	O
HETATM	3731	O	HOH	718	96.397	65.225	43.866	1.00	54.78	O
HETATM	3732	O	HOH	719	149.381	55.765	8.190	1.00	46.95	O
HETATM	3733	O	HOH	723	115.502	77.990	9.376	1.00	46.76	O
HETATM	3734	O	HOH	725	76.437	79.568	26.459	1.00	59.19	O
HETATM	3735	O	HOH	726	95.324	49.183	27.259	1.00	51.94	O
HETATM	3736	O	HOH	727	111.936	82.375	12.461	1.00	38.86	O
HETATM	3737	O	HOH	728	133.312	81.928	11.453	1.00	51.26	O
HETATM	3738	O	HOH	729	107.996	85.280	18.442	1.00	39.71	O
HETATM	3739	O	HOH	730	148.848	63.651	-10.490	1.00	48.09	O
HETATM	3740	O	HOH	733	134.306	63.018	10.766	1.00	31.65	O
HETATM	3741	O	HOH	735	124.671	60.360	17.610	1.00	52.69	O
HETATM	3742	O	HOH	736	111.727	60.489	42.963	1.00	62.15	O
HETATM	3743	O	HOH	737	134.980	50.157	7.477	1.00	60.92	O
HETATM	3744	O	HOH	738	146.654	76.277	6.833	1.00	40.87	O
HETATM	3745	O	HOH	739	89.251	64.149	19.814	1.00	33.88	O
HETATM	3746	O	HOH	741	105.433	55.341	8.828	1.00	58.55	O
HETATM	3747	O	HOH	749	88.458	78.199	19.817	1.00	66.31	O
HETATM	3748	O	HOH	750	106.898	44.639	18.376	1.00	56.87	O
HETATM	3749	O	HOH	751	105.309	68.078	49.132	1.00	66.24	O
HETATM	3750	O	HOH	752	92.980	48.934	17.873	1.00	42.58	O
HETATM	3751	O	HOH	753	100.420	53.758	15.446	1.00	60.31	O
HETATM	3752	O	HOH	754	120.798	66.196	40.717	1.00	66.93	O
HETATM	3753	O	HOH	755	108.406	89.679	12.448	1.00	61.48	O
HETATM	3754	O	HOH	757	132.463	72.528	4.509	1.00	59.31	O
HETATM	3755	O	HOH	761	127.038	77.545	21.661	1.00	47.91	O
HETATM	3756	O	HOH	762	106.459	50.413	17.617	1.00	59.90	O

-continued

HETATM	3757	O	HOH	765	119.622	72.534	26.691	1.00	51.38	O
HETATM	3758	O	HOH	766	118.174	72.450	5.241	1.00	68.42	O
HETATM	3759	O	HOH	768	105.322	87.067	41.471	1.00	68.21	O
HETATM	3760	O	HOH	770	105.218	41.445	29.836	1.00	63.03	O
HETATM	3761	O	HOH	771	83.989	78.004	39.580	1.00	67.38	O
HETATM	3762	O	HOH	772	148.829	67.245	20.069	1.00	44.56	O
HETATM	3763	O	HOH	773	106.544	84.270	11.229	1.00	40.15	O
HETATM	3764	O	HOH	775	105.699	39.006	23.992	1.00	68.38	O
HETATM	3765	O	HOH	778	114.007	85.900	33.916	1.00	42.88	O
HETATM	3766	O	HOH	780	93.889	60.095	23.291	1.00	62.44	O
HETATM	3767	O	HOH	781	129.215	73.681	21.887	1.00	37.93	O
HETATM	3768	O	HOH	787	81.781	76.779	28.784	1.00	61.15	O
HETATM	3769	O	HOH	788	147.918	62.639	14.966	1.00	39.80	O
HETATM	3770	O	HOH	789	79.084	63.731	35.792	1.00	60.46	O
HETATM	3771	O	HOH	791	106.162	72.361	37.935	1.00	51.27	O
HETATM	3772	O	HOH	793	113.985	72.209	7.836	1.00	54.33	O
HETATM	3773	O	HOH	794	147.561	84.941	11.984	1.00	59.95	O
HETATM	3774	O	HOH	796	117.356	86.976	18.333	1.00	57.65	O
HETATM	3775	O	HOH	797	96.398	58.891	24.526	1.00	48.25	O
HETATM	3776	O	HOH	799	113.947	81.311	24.929	1.00	48.99	O
HETATM	3777	O	HOH	800	130.861	56.862	14.557	1.00	67.81	O
HETATM	3778	O	HOH	803	136.966	56.000	-10.559	1.00	66.93	O
HETATM	3779	O	HOH	807	120.744	54.584	40.505	1.00	65.23	O
HETATM	3780	O	HOH	809	111.191	79.767	14.798	1.00	39.00	O
HETATM	3781	O	HOH	810	100.504	80.761	16.287	1.00	40.40	O
HETATM	3782	O	HOH	812	119.309	46.953	19.630	1.00	58.74	O
HETATM	3783	O	HOH	817	79.924	78.741	21.466	1.00	62.43	O
HETATM	3784	O	HOH	819	114.995	48.374	8.804	1.00	68.51	O
HETATM	3785	O	HOH	823	121.219	69.376	9.088	1.00	61.14	O
HETATM	3786	O	HOH	824	83.259	52.990	49.620	1.00	42.61	O
HETATM	3787	O	HOH	826	73.121	53.007	46.366	1.00	51.95	O
HETATM	3788	O	HOH	829	125.131	57.072	24.888	1.00	43.39	O
HETATM	3789	O	HOH	830	117.478	81.142	25.399	1.00	63.97	O
HETATM	3790	O	HOH	832	118.060	80.843	9.442	1.00	68.90	O
HETATM	3791	O	HOH	833	125.309	81.768	10.259	1.00	36.71	O
HETATM	3792	O	HOH	834	106.669	69.383	1.728	1.00	62.38	O
HETATM	3793	O	HOH	836	134.415	57.557	20.513	1.00	51.26	O
HETATM	3794	O	HOH	837	138.774	48.063	14.052	1.00	62.75	O
HETATM	3795	O	HOH	838	105.034	90.698	36.793	1.00	43.22	O
HETATM	3796	O	HOH	839	94.179	62.599	22.253	1.00	39.73	O
HETATM	3797	O	HOH	840	102.012	56.721	46.229	1.00	49.59	O
HETATM	3798	O	HOH	842	129.445	55.023	4.305	1.00	44.96	O
HETATM	3799	O	HOH	843	95.363	50.937	5.969	1.00	60.45	O
HETATM	3800	O	HOH	847	148.499	52.780	8.080	1.00	60.01	O
HETATM	3801	O	HOH	852	90.466	70.795	38.792	1.00	60.50	O
HETATM	3802	O	HOH	853	138.576	76.612	2.592	1.00	62.24	O
HETATM	3803	O	HOH	855	116.588	74.760	7.223	1.00	60.72	O
HETATM	3804	O	HOH	860	113.703	91.874	24.531	1.00	68.47	O
HETATM	3805	O	HOH	861	130.923	52.830	6.921	1.00	62.84	O
HETATM	3806	O	HOH	862	142.316	48.653	13.579	1.00	50.41	O
HETATM	3807	O	HOH	863	132.567	53.947	3.095	1.00	68.97	O
HETATM	3808	O	HOH	865	100.473	47.680	26.060	1.00	65.28	O
HETATM	3809	O	HOH	866	133.655	75.864	1.041	1.00	69.12	O
HETATM	3810	O	HOH	867	122.519	76.254	7.931	1.00	61.12	O
HETATM	3811	O	HOH	868	84.905	74.842	20.730	1.00	46.62	O
HETATM	3812	O	HOH	869	148.011	52.884	0.797	1.00	66.79	O
HETATM	3813	O	HOH	872	94.647	87.503	38.810	1.00	38.25	O
HETATM	3814	O	HOH	873	101.350	92.083	26.520	1.00	62.62	O
HETATM	3815	O	HOH	875	126.984	55.912	-0.651	1.00	69.71	O
HETATM	3816	O	HOH	878	127.346	68.643	12.063	1.00	33.35	O
HETATM	3817	O	HOH	879	117.590	70.113	8.367	1.00	32.01	O
HETATM	3818	O	HOH	884	94.685	91.830	3.118	1.00	53.98	O
HETATM	3819	O	HOM	886	94.421	91.554	39.231	1.00	35.13	O
HETATM	3820	O	HOH	887	90.370	90.226	5.222	1.00	36.45	O
HETATM	3821	O	HOH	888	138.171	82.094	23.696	1.00	43.62	O
HETATM	3822	O	HOH	890	145.344	74.873	18.144	1.00	52.45	O
HETATM	3823	C	HOH	891	86.699	56.553	44.193	1.00	59.80	O
HETATM	3824	O	HOH	895	110.253	51.388	39.073	1.00	64.37	O
HETATM	3825	O	HOH	899	142.548	59.418	25.624	1.00	68.03	O
HETATM	3826	O	HOH	902	96.309	63.463	47.551	1.00	68.27	O
HETATM	3827	O	HOH	904	103.052	43.719	26.788	1.00	64.56	O
HETATM	3828	O	HOH	905	148.314	72.538	19.514	1.00	53.02	O
HETATM	3829	O	HOH	906	115.081	80.764	15.768	1.00	37.40	O
HETATM	3830	O	HOH	907	111.660	74.882	5.430	1.00	36.15	O
HETATM	3831	O	HOH	908	91.410	88.940	39.058	1.00	40.21	O
HETATM	3832	O	HOH	909	92.100	65.397	41.837	1.00	42.61	O
HETATM	3833	O	HOH	910	135.015	70.210	22.164	1.00	32.10	O
HETATM	3834	O	HOH	911	124.196	60.165	24.502	1.00	68.95	O
HETATM	3835	O	HOH	912	104.972	48.595	38.399	1.00	50.34	O

-continued

HETATM	3836	O	HOH	913	143.458	60.042	28.053	1.00	36.04	O
HETATM	3837	O	HOH	916	101.435	59.347	18.933	1.00	50.24	O
HETATM	3838	O	HOH	917	112.207	49.761	38.732	1.00	26.79	O
HETATM	3839	O	HOH	918	129.684	70.406	8.637	1.00	46.40	O
HETATM	3840	O	HOH	921	80.125	93.172	15.865	1.00	52.80	O
HETATM	3841	O	HOH	922	149.474	69.335	14.961	1.00	54.64	O
HETATM	3842	O	HOH	926	102.735	61.951	20.408	1.00	35.26	O
HETATM	3843	O	HOH	927	70.905	53.569	44.583	1.00	70.52	O
HETATM	3844	O	HOH	929	114.913	79.874	33.698	1.00	57.49	O
HETATM	3845	O	HOH	930	150.193	75.660	8.945	1.00	35.94	O
HETATM	3846	O	HOH	931	108.648	54.745	43.966	1.00	62.03	O
HETATM	3847	O	HOH	936	121.915	58.864	24.758	1.00	55.08	O
HETATM	3848	O	HOH	937	79.417	58.337	48.896	1.00	68.62	O
HETATM	3849	O	HOH	938	113.378	43.843	23.780	1.00	41.09	O
HETATM	3850	O	HOH	939	120.219	59.743	27.131	1.00	44.37	O
HETATM	3851	O	HOH	941	105.234	64.396	-0.669	1.00	73.28	O
HETATM	3852	O	HOH	942	141.057	80.868	-0.762	1.00	67.90	O
HETATM	3853	O	HOH	944	119.413	75.184	6.755	1.00	98.67	O
HETATM	3854	O	HOH	945	95.626	74.384	14.294	1.00	63.69	O
HETATM	3855	O	HOH	946	95.387	53.160	20.326	1.00	59.76	O
HETATM	3856	O	HOH	947	112.354	72.038	3.479	1.00	55.13	O
HETATM	3857	O	HOH	961	116.417	63.126	34.645	1.00	53.04	O
HETATM	3858	O	HOH	962	91.960	70.760	43.791	1.00	62.09	O
HETATM	3859	O	HOH	964	80.831	84.466	14.233	1.00	66.83	O
HETATM	3860	O	HOH	966	111.313	64.422	5.416	1.00	43.56	O
HETATM	3861	O	HOH	968	133.045	80.261	24.904	1.00	59.86	O
HETATM	3862	O	HOH	971	113.856	45.592	40.153	1.00	68.81	O
HETATM	3863	O	HOH	973	149.882	57.333	6.661	1.00	61.17	O
HETATM	3864	O	HOH	974	114.479	45.337	23.893	1.00	48.82	O
HETATM	3865	O	HOH	976	122.683	49.979	23.699	1.00	54.50	O
HETATM	3866	O	HOH	977	107.449	93.037	22.262	1.00	67.52	O
HETATM	3867	O	HOH	980	71.623	55.665	43.963	1.00	50.43	O
HETATM	3868	O	HOH	983	81.115	79.690	16.340	1.00	68.34	O
HETATM	3869	O	HOH	984	146.095	68.641	21.063	1.00	40.33	O
HETATM	3870	O	HOH	989	84.591	87.656	11.809	1.00	61.62	O
HETATM	3871	O	HOH	990	101.284	84.890	35.573	1.00	66.53	O
HETATM	3872	O	HOH	991	132.290	57.405	16.338	1.00	66.86	O
HETATM	3873	O	HOH	992	107.181	71.461	43.131	1.00	68.43	O
HETATM	3874	O	HOH	996	121.732	77.353	22.459	1.00	56.10	O
HETATM	3875	O	HOH	997	123.339	62.223	9.181	1.00	53.79	O
HETATM	3876	O	HOH	999	118.564	57.129	2.150	1.00	64.38	O
HETATM	3877	O	HOH	1002	113.406	85.261	25.792	1.00	54.44	O
HETATM	3876	O	HOH	1003	132.676	51.930	17.206	1.00	68.65	O
HETATM	3879	O	HOH	1006	82.100	75.518	31.280	1.00	51.37	O
HETATM	3880	O	HOH	1007	91.217	86.172	10.703	1.00	68.50	O
HETATM	3881	O	HOH	1011	148.150	63.664	-4.949	1.00	66.39	O
HETATM	3882	O	HOH	1012	108.584	47.618	13.690	1.00	63.35	O
HETATM	3883	O	HOH	1014	104.916	54.259	6.694	1.00	66.63	O
HETATM	3884	O	HOH	1021	127.338	67.350	-0.507	1.00	68.51	O
HETATM	3885	O	HOH	1024	100.255	43.755	35.224	1.00	49.55	O
HETATM	3886	O	HOH	1026	113.002	85.034	18.817	1.00	68.03	O
HETATM	3887	O	HOH	1027	74.446	56.955	41.184	1.00	34.26	O
HETATM	3888	O	HOH	1032	123.923	66.490	27.749	1.00	51.93	O
HETATM	3889	O	HOH	1037	105.661	94.018	14.310	1.00	48.05	O
HETATM	3890	O	HOH	1045	85.110	67.600	42.845	1.00	61.60	O
HETATM	3891	O	HOH	1049	72.485	57.802	45.989	1.00	68.63	O
HETATM	3892	O	HOH	1051	104.785	74.784	39.154	1.00	60.69	C
HETATM	3893	O	HOH	1053	104.639	40.347	24.518	1.00	61.31	O
HETATM	3894	O	HOH	1054	142.840	80.523	20.021	1.00	68.20	O
HETATM	3895	O	HOH	1056	123.658	55.426	39.072	1.00	68.01	O
HETATM	3896	O	HOH	1057	122.409	54.809	6.777	1.00	68.72	O
HETATM	3897	O	HOH	1060	148.405	75.478	20.015	1.00	68.99	O
HETATM	3898	O	HOH	1066	101.285	46.434	21.329	1.00	69.66	O
HETATM	3899	O	HOH	1068	101.265	47.738	38.183	1.00	52.34	O
HETATM	3900	O	HOH	1072	116.191	83.171	15.683	1.00	63.11	O
HETATM	3901	O	HOH	1076	124.162	83.118	19.379	1.00	65.19	O
HETATM	3902	O	HOH	1077	114.649	91.913	27.612	1.00	63.68	O
HETATM	3903	O	HOH	1078	131.138	72.022	1.639	1.00	65.80	O
HETATM	3904	O	HOH	1079	104.565	95.248	23.931	1.00	67.66	O
HETATM	3905	O	HOH	1080	130.600	83.061	14.460	1.00	68.73	O
HETATM	3906	O	HOH	1081	108.024	57.385	44.494	1.00	68.47	O
HETATM	3907	O	HOH	1089	98.180	52.040	22.425	1.00	57.82	O
HETATM	3908	O	HOH	1095	123.035	48.662	12.121	1.00	49.75	O
HETATM	3909	O	HOH	1100	116.951	82.153	13.434	1.00	47.33	O
HETATM	3910	O	HOH	1109	93.000	74.011	11.563	1.00	65.00	O
HETATM	3911	O	HOH	1110	84.826	60.423	43.980	1.00	68.47	O
HETATM	3912	O	HOH	1114	95.995	48.302	8.024	1.00	46.89	O
HETATM	3913	O	HOH	1115	146.331	50.245	-5.119	1.00	55.03	O
HETATM	3914	O	HOH	1117	93.037	80.264	22.271	1.00	36.08	O

-continued

HETATM	3915	O	HOH	1118	127.120	59.841	19.240	1.00	36.51	O
HETATM	3916	O	HOH	1123	130.326	80.122	18.283	1.00	54.14	O
HETATM	3917	O	HOH	1127	122.797	71.467	7.444	1.00	61.33	O
HETATM	3918	O	HOH	1128	86.326	63.775	40.835	1.00	65.83	O
HETATM	3919	O	HOH	1129	129.934	60.674	26.265	1.00	67.06	O
HETATM	3920	O	HOH	1132	91.126	55.593	11.580	1.00	55.91	O
HETATM	3921	O	HOH	1136	131.604	57.222	-9.584	1.00	62.55	O
HETATM	3922	O	HOH	1137	122.963	68.163	16.106	1.00	33.32	O
HETATM	3923	O	HOH	1140	107.890	88.486	9.887	1.00	61.56	C
HETATM	3924	O	HOH	1142	143.969	58.642	-10.289	1.00	69.08	O
HETATM	3925	O	HOH	1143	88.527	78.564	-1.195	1.00	66.36	O
HETATM	3926	O	HOH	1146	109.850	50.598	43.199	1.00	64.27	O
HETATM	3927	O	HOH	1151	112.701	76.952	6.277	1.00	55.30	O
HETATM	3928	O	HOH	1154	102.564	50.394	12.484	1.00	59.53	O
HETATM	3929	O	HOH	1161	95.856	79.770	13.615	1.00	60.09	O
HETATM	3930	O	HOH	1162	149.220	72.694	15.463	1.00	36.11	O
HETATM	3931	O	HOH	1167	134.026	86.608	28.831	1.00	55.75	O
HETATM	3932	O	HOH	1168	137.288	47.676	-0.383	1.00	58.53	O
HETATM	3933	O	HOH	1169	96.461	76.369	-1.039	1.00	40.84	O
HETATM	3934	O	HOH	1170	146.839	76.924	18.226	1.00	62.40	O
HETATM	3935	O	HOH	1173	84.778	62.413	46.009	1.00	56.40	O
HETATM	3936	O	HOH	1174	104.665	61.328	-0.147	1.00	68.18	O
HETATM	3937	O	HOH	1176	148.238	49.557	15.253	1.00	68.84	O
HETATM	3938	O	HOH	1180	96.826	57.686	5.466	1.00	68.82	O
HETATM	3939	O	HOH	1181	97.848	45.596	18.230	1.00	68.53	O
HETATM	3940	O	HOH	1183	105.561	78.152	46.280	1.00	55.13	O
HETATM	3941	O	HOH	1184	148.363	55.663	18.453	1.00	67.78	O
HETATM	3942	O	HOH	1188	117.761	72.763	3.201	1.00	49.39	O
HETATM	3943	O	HOH	1190	129.206	55.861	-5.442	1.00	69.86	O
HETATM	3944	O	HOH	1195	107.481	76.284	39.087	1.00	57.19	O
HETATM	3945	O	HOH	1206	122.685	66.549	4.934	1.00	62.97	O
HETATM	3946	O	HOH	1207	150.879	41.867	5.427	1.00	67.80	O
HETATM	3947	O	HOH	1216	134.077	45.934	8.123	1.00	68.54	O
HETATM	3948	O	HOH	1217	92.702	54.498	4.335	1.00	68.29	O
HETATM	3949	O	HOH	1227	133.307	89.606	16.031	1.00	55.60	O
HETATM	3950	O	HOH	1228	145.314	58.907	23.524	1.00	57.48	O
HETATM	3951	O	HOH	1231	121.333	47.473	28.343	1.00	42.57	O
HETATM	3952	O	HOH	1237	80.672	64.102	43.307	1.00	62.67	O
HETATM	3953	O	HOH	1239	79.197	76.085	29.202	1.00	42.02	O
HETATM	3954	O	HOH	1240	147.532	79.940	6.435	1.00	49.20	O
HETATM	3955	O	HOH	1241	105.341	73.622	43.925	1.00	46.80	O
HETATM	3956	O	HOH	1242	108.748	84.315	11.317	1.00	43.50	O
HETATM	3957	O	HOH	1243	113.748	76.205	13.481	1.00	31.05	O
HETATM	3958	O	HOH	1244	106.486	82.249	41.211	1.00	53.73	O
HETATM	3959	O	HOH	1245	123.229	67.990	30.863	1.00	67.62	O
HETATM	3960	O	HOH	1246	97.244	56.293	3.245	1.00	59.53	O
HETATM	3961	O	HOH	1247	84.115	75.748	18.158	1.00	47.44	O
HETATM	3962	O	HOH	1248	92.641	62.480	43.494	1.00	56.54	O
HETATM	3963	O	HOH	1249	126.850	67.707	7.524	1.00	63.22	O
HETATM	3964	O	HOH	1250	116.737	46.525	9.414	1.00	60.31	O
HETATM	3965	O	HOH	1251	99.435	55.524	20.442	1.00	68.76	O
HETATM	3966	O	HOH	1252	93.533	48.432	11.284	1.00	64.31	O
HETATM	3967	O	HOH	1253	115.458	55.820	8.527	1.00	68.91	O
HETATM	3968	O	HOH	1254	94.383	48.132	30.166	1.00	55.54	O
HETATM	3969	O	HOH	1255	136.004	53.964	17.602	1.00	50.55	O
HETATM	3970	O	HOH	1256	97.765	60.337	0.278	1.00	67.66	O
HETATM	3971	O	HOH	1257	81.887	70.128	40.015	1.00	60.06	O
HETATM	3972	O	HOH	1258	98.568	43.853	36.969	1.00	60.96	O
HETATM	3973	O	HOH	1259	102.312	50.226	23.207	1.00	69.15	O
HETATM	3974	O	HOH	1260	93.845	73.542	7.463	1.00	62.17	O
HETATM	3975	O	HOH	1261	122.247	50.835	30.996	1.00	66.32	O
HETATM	3976	O	HOH	1262	137.839	46.740	1.638	1.00	44.22	O
HETATM	3977	O	HOH	1263	107.295	79.492	3.520	1.00	56.86	O
HETATM	3978	O	HOH	1264	108.339	49.640	21.504	1.00	48.82	O
HETATM	3979	O	HOH	1265	105.132	63.518	48.797	1.00	62.13	O
HETATM	3960	O	HOH	1266	139.420	62.113	23.787	1.00	50.94	O
HETATM	3981	O	HOH	1267	144.043	77.286	3.516	1.00	68.14	O
HETATM	3982	O	HOH	1268	149.733	53.900	4.381	1.00	56.17	O
HETATM	3983	O	HOH	1269	103.004	91.675	22.454	1.00	51.28	O
HETATM	3984	O	HOH	1270	102.342	79.977	8.282	1.00	60.86	O
HETATM	3985	O	HOH	1271	104.432	79.198	8.137	1.00	49.45	O
HETATM	3986	O	HOH	1272	96.642	78.325	15.154	1.00	49.69	O
HETATM	3987	O	HOH	1273	123.113	83.532	10.129	1.00	46.69	O
HETATM	3988	O	HOH	1274	108.924	75.712	35.457	1.00	44.24	O
HETATM	3989	O	HOH	1275	120.284	52.133	13.839	1.00	49.42	O
HETATM	3990	O	HOH	1276	153.804	67.675	3.008	1.00	68.53	C
HETATM	3991	O	HOH	1277	132.756	49.791	2.618	1.00	54.77	O
HETATM	3992	O	HOH	1278	123.687	61.097	-1.686	1.00	66.47	O
HETATM	3993	O	HOH	1279	79.098	85.995	16.502	1.00	68.34	O

-continued

HETATM	3994	O	HOH	1280	81.604	77.273	22.663	1.00	51.85	O
HETATM	3995	O	HOH	1281	97.665	46.523	21.377	1.00	66.98	O
HETATM	3996	O	HOH	1282	124.226	53.393	42.604	1.00	56.65	O
HETATM	3997	O	HOH	1283	70.053	51.433	45.374	1.00	31.76	O
HETATM	3998	O	HOH	1284	133.004	59.283	22.298	1.00	51.14	O
HETATM	3999	O	HOH	1285	110.435	58.745	9.141	1.00	66.24	O
HETATM	4000	O	M0H	1286	131.690	83.699	10.424	1.00	50.89	O
HETATM	4001	O	HOH	1287	87.121	83.954	6.897	1.00	61.10	O
HETATM	4002	O	HOH	1289	103.343	70.654	47.251	1.00	59.87	O
HETATM	4003	O	HOH	1290	151.878	57.545	4.368	1.00	68.93	O
HETATM	4004	O	HOH	1291	109.757	52.533	5.140	1.00	68.61	O
HETATM	4005	O	HOH	1292	137.500	85.244	14.713	1.00	48.53	O
HETATM	4006	O	HOH	1293	99.481	43.592	30.277	1.00	56.76	O
HETATM	4007	O	HOH	1294	79.393	66.499	44.205	1.00	51.03	O
HETATM	4008	O	HOH	1295	93.025	76.731	12.952	1.00	68.06	O
HETATM	4009	O	HOH	1296	104.177	39.636	37.064	1.00	66.28	O
HETATM	4010	C	HOH	1297	131.482	71.092	26.769	1.00	63.53	O
HETATM	4011	O	HOH	1299	108.732	64.733	46.862	1.00	59.61	O
HETATM	4012	O	HOH	1300	85.693	84.234	8.773	1.00	61.29	O
HETATM	4013	O	HOH	1301	130.439	55.137	19.928	1.00	68.52	O
HETATM	4014	O	HOH	1302	126.942	81.225	22.497	1.00	68.12	O
HETATM	4015	O	HOH	1303	85.867	53.208	45.199	1.00	54.32	O
HETATM	4016	O	HOH	1304	104.487	89.634	40.115	1.00	64.91	O
HETATM	4017	O	HOH	1305	106.217	68.163	-1.625	1.00	55.54	O
HETATM	4018	O	HOH	1306	105.015	51.028	40.376	1.00	45.33	O
HETATM	4019	O	HOH	1307	120.170	70.835	39.052	1.00	58.73	O
HETATM	4020	O	HOH	1308	121.326	61.115	30.539	1.00	67.23	O
HETATM	4021	O	HOH	1309	107.923	60.643	46.488	1.00	69.06	O
HETATM	4022	O	HOH	1310	78.786	53.486	48.325	1.00	55.45	O
HETATM	4023	O	HOH	1311	130.804	55.401	22.465	1.00	59.73	O
HETATM	4024	O	HOH	1312	150.487	50.345	12.892	1.00	61.66	O
HETATM	4025	O	HOH	1313	100.834	38.834	32.531	1.00	62.67	O
HETATM	4026	O	HOH	1314	111.244	65.102	1.801	1.00	68.69	O
HETATM	4027	O	HOH	1315	132.117	79.062	22.385	1.00	40.28	O
HETATM	4025	O	HOH	1316	91.048	57.371	42.981	1.00	57.35	O
HETATM	4029	O	HOH	1317	144.712	49.327	0.134	1.00	49.54	O
HETATM	4030	O	HOH	1318	147.789	61.584	-9.156	1.00	68.51	C
HETATM	4031	O	HOH	1319	123.090	61.674	6.437	1.00	69.05	C
HETATM	4032	O	HOH	1320	116.358	60.623	35.690	1.00	69.30	O
HETATM	4033	O	HOH	1321	113.530	91.177	21.954	1.00	52.62	O
HETATM	4034	O	HOH	1322	110.177	74.769	14.221	1.00	65.83	O
HETATM	4035	O	HOH	1323	135.219	50.902	-6.112	1.00	68.00	O
HETATM	4036	O	HOH	1324	121.026	52.096	9.382	1.00	68.04	O
HETATM	4037	O	HOH	1325	86.410	84.214	10.939	1.00	54.69	O
HETATM	4036	O	HOH	1326	92.066	62.207	-0.340	1.00	62.69	O
HETATM	4039	O	HOH	1327	108.159	72.272	1.047	1.00	69.41	C
HETATM	4040	O	HOH	1328	136.575	47.899	9.387	1.00	67.46	O
HETATM	4041	O	HOH	1329	112.693	55.745	39.945	1.00	50.31	O
HETATM	4042	O	HOH	1330	142.437	65.379	-12.250	1.00	63.99	O
HETATM	4043	O	HOH	1331	97.845	53.121	3.695	1.00	68.33	O
HETATM	4044	O	HOH	1332	135.048	60.985	20.232	1.00	43.95	O
HETATM	4045	O	HOH	1334	131.683	75.485	22.258	1.00	35.53	O
HETATM	4046	O	HOH	1335	105.140	83.991	8.520	1.00	63.09	O
HETATM	4047	C	HOH	1336	119.421	70.763	31.673	1.00	42.24	O
HETATM	4048	O	HOH	1337	100.568	48.021	23.330	1.00	49.89	O
HETATM	4049	O	HOH	1338	133.982	54.355	16.339	1.00	62.13	O
HETATM	4050	O	HOH	1339	139.885	47.835	4.658	1.00	63.64	O
HETATM	4051	O	HOH	1340	150.581	62.937	15.908	1.00	63.60	O
HETATM	4052	O	HOH	1341	152.210	51.862	8.757	1.00	61.88	O
HETATM	4053	C	HOH	1342	92.864	62.277	3.434	1.00	57.80	O
HETATM	4054	O	HOH	1343	111.310	79.489	44.276	1.00	67.97	O
HETATM	4055	O	HOH	1344	149.427	48.324	7.299	1.00	59.90	O
HETATM	4056	O	HOH	1345	111.003	79.259	3.914	1.00	66.53	O
HETATM	4057	O	HOH	1346	116.893	54.202	7.477	1.00	47.23	O
HETATM	4058	O	HOH	1347	86.047	83.848	13.378	1.00	53.04	O
HETATM	4059	O	HOH	1348	117.820	76.586	7.356	1.00	57.31	O
HETATM	4060	O	HOH	1349	111.270	97.127	33.425	1.00	48.23	O
HETATM	4061	O	HOH	1350	129.000	77.928	24.673	1.00	44.60	O
HETATM	4062	O	HOH	1351	124.726	89.092	16.877	1.00	59.34	O
HETATM	4063	O	HOH	1352	93.181	64.700	49.080	1.00	52.82	O
HETATM	4064	O	HOH	1353	79.571	72.862	32.787	1.00	68.35	O
HETATM	4065	O	HOH	1354	115.741	90.948	32.009	1.00	48.04	O
HETATM	4066	C	HOH	1356	85.780	75.697	15.005	1.00	50.57	O
HETATM	4067	O	HOH	1357	112.933	95.254	27.038	1.00	44.69	O
CONNECT	403	404								
CONNECT	404	403	405	407						
CONNECT	405	404	406							
CONNECT	406	405								
CONNECT	407	404	408							

-continued

CONNECT	408	407	409	
CONNECT	409	408	410	
CONNECT	410	409		
CONNECT	459	460		
CONNECT	460	459	461	463
CONNECT	461	460	462	
CONNECT	462	461		
CONNECT	463	460	464	
CONNECT	464	463	465	
CONNECT	465	464	466	
CONNECT	466	465		
CONNECT	576	577		
CONNECT	577	576	578	580
CONNECT	578	577	579	
CONNECT	579	578		
CONNECT	580	577	581	
CONNECT	581	580	582	
CONNECT	582	581	583	
CONNECT	583	582		
CONNECT	882	883		
CONNECT	883	882	884	886
CONNECT	884	883	885	
CONNECT	885	884		
CONNECT	886	883	887	
CONNECT	887	886	888	
CONNECT	888	887	889	
CONNECT	889	888		
CONNECT	1094	1095		
CONNECT	1095	1094	1096	1098
CONNECT	1096	1095	1097	
CONNECT	1097	1096		
CONNECT	1098	1095	1099	
CONNECT	1099	1010	1100	
CONNECT	1100	1099	1101	
CONNECT	1101	1100		
CONNECT	1211	1212		
CONNECT	1212	1211	1213	1215
CONNECT	1213	1212	1214	
CONNECT	1214	1213		
CONNECT	1215	1212	1216	
CONNECT	1216	1215	1217	
CONNECT	1217	1216	1218	
CONNECT	1218	1217		
CONNECT	2707	2708		
CONNECT	2708	2707	2709	2711
CONNECT	2709	2708	2710	
CONNECT	2710	2709		
CONNECT	2711	2708	2712	
CONNECT	2712	2711	2713	
CONNECT	2713	2712	2714	
CONNECT	2714	2713		
CONNECT	2733	2734		
CONNECT	2734	2733	2735	2737
CONNECT	2735	2734	2736	
CONNECT	2736	2735		
CONNECT	2737	2734	2738	
CONNECT	2738	2737	2739	
CONNECT	2739	2738	2740	
CONNECT	2740	2739		
CONNECT	2934	2935		
CONNECT	2935	2934	2936	2938
CONNECT	2936	2935	2937	
CONNECT	2937	2936		
CONNECT	2938	2935	2939	
CONNECT	2939	2938	2940	
CONNECT	2940	2939	2941	
CONNECT	2941	2940		
CONNECT	2970	2971		
CONNECT	2971	2970	2972	2974
CONNECT	2972	2971	2973	
CONNECT	2973	2972		
CONNECT	2974	2971	2975	
CONNECT	2975	2974	2976	
CONNECT	2976	2975	2977	
CONNECT	2977	2976		
CONNECT	3158	3159		
CONNECT	3159	3158	3160	3162
CONNECT	3160	3159	3161	
CONNECT	3161	3160		

Huete-Pérez, J. A., Wu, J. C., Whitby, F. G., & Wang, C. C. Identification of the IMP binding site in the IMP dehydrogenase from *Tritrichomonas foetus*. *Biochemistry* 34, 13889–13894 (1995).

Jayaram, H. N., Gearehbaghi, K., Jayaram, N. H., Rieser, J., Krohn, K. & Paull, K. D. Clinical pharmacokinetic study of tiazofurin administered as a 1-hr infusion. *Int. J. Cancer* 51, 182–188 (1992).

In. Jones, T. A. A graphics model building and refinement system for macromolecules. *J. Appl. Crystallogr.* 11, 268–272(1968).

Kabsch, W. & Saender, C. Dictionary of protein secondary structure: pattern recognition of hydrogen-bonded and geometrical features. *Biopolymers* 22, 2577–2637 (1983).

Kerr, K. M. & Hedstrom, L. The role of conserved carboxylate residues in IMP dehydrogenase and identification of a transition state analog. *Biochemistry* 36, 13365–13373 (1997).

Kiguchi, K., Collart, F. R., Henning-Chubb, C., and Huberman, E. Induction of cell differentiation in melanoma cells by inhibitors of IMP dehydrogenase: altered patterns of IMP dehydrogenase expression and activity. *Cell Growth and Differen.* 1, 259–270 (1990).

Laskowski, R. A., Macarthur, M. W., Moss, D. S. & Thornton, J. M. PROCHECK—A program to check the stereochemical quality of protein structures. *J. Appl. Crystallogr.* 26, 283–291 (1993).

Link, J. O. & Straub, K. Trapping of an IMP dehydrogenase-substrate covalent intermediate by mycophenolic acid. *J. Am. Chem. Soc.* 118, 2091–2092 (1996).

Navaza, J. & Sludijan, P. AmoRe: An automated molecular replacement package. *Methods Enzymol.* 276, 581–594 (1997).

Nimmegern, E., Fox, T., Fleming, M. A. & Thomson, J. A. Conformational changes and stabilization of inosine 5'-monophosphate dehydrogenase associated with ligand binding and inhibition by mycophenolic acid. *J. Biol. Chem.* 271, 19421–19427 (1996).

Otwinowski, Z. & Minor, W. Processing of X-ray diffraction data collected in oscillation mode. *Methods Enzymol.* 276, 307–326 (1997).

Otwinowski, Z. MLPHARE-Maximum likelihood refinement of heavy atom parameters. In *Isomorphous Replacement and Anomalous Scattering*. (Wolf, W., Evans, P. R., & Leslie, A. G. W., eds), pp 80–86, Science and Engineering Research Council, Daresbury, England (1991).

Pankiewicz, K. W. Novel nicotinamide adenine dinucleotide analogues as potential anticancer agents: quest for

specific inhibition of inosine monophosphate dehydrogenase. *Pharmacol. Ther.* 76, 89–100 (1997).

Pannu, N. S., Murshudov, G. N., Dodson, E. J. & Read, R. Incorporation of prior phase information strengthens maximum likelihood structural refinement. *Acta Crystallogr. D, Acta Crystallogr D Biol Crystallogr.* 54,1285–94 (1998).

Ramakrishnan, V. and Biou, V. Treatment of multiwavelength anomalous diffraction data as a special case of multiple isomorphous replacement. *Methods Enzymol.* 276, 538–557 (1997).

Read, R. J. SIGMAA—Improved fourier coefficients using calculated phases. *Acta Crystallogr.* A42, 140–149 (1986).

Rice, L. M. & Bringer, A. T. Torsion angle-dynamics: Reduced variable conformational sampling enhances crystallographic structure refinement. *Proteins* 19, 277–290 (1994).

Sintchak, M. D., Fleming, M. A., Futer, O., Raybuck, S. A., Chambers, S. P., Caron, P. R., Murcko, M. A., & Wilson, K. P. Structure and mechanism of inosine monophosphate dehydrogenase in complex with the immunosuppressant mycophenolic acid. *Cell* 85, 921–930 (1996).

Smith, D. W., Frankel, L. R., Mathers, L. H., Tang, A. T., Atiagno, R. L. & Prober, C. G. A controlled trial of aerosolized ribavirin in infants receiving mechanical ventilation for severe respiratory syncytial virus infection. *N. Engl. J. Med.* 325, 24–29 (1991).

Wang, W., Papov, V. V., Minakawa, N., Matsuda, A., Biemann, & Hedstrom, L. Inactivation of Inosine 5'-monophosphate dehydrogenase by the antiviral agent 5-ethynyl-1-β-D-ribofuranosylimidazole-4-carboxamide 5'-monophosphate. *Biochemistry* 101 (1996) 35, 95–101.

Westbrook, E. M. & Naday, I. Charge-coupled device-based area detectors. *Methods Enzymol.* 276, 244–268 (1997).

Whitby, F. G., Luecke, H., Khun, P., Somoza, J. R., Huete-Perez, J. A., Phillips, J. D., Hill, C. P., Fletterick, R. J., & Wang, C. C. Crystal structure of *Tritrichomonas foetus* Inosine-5'-monophosphate dehydrogenase and the enzyme-product complex. *Biochemistry* 36, 10666–10674 (1997).

Xiang, B. & Markham, G. D. Probing the mechanism of inosine monophosphate dehydrogenase with kinetic isotope effects and NMR determination of the hydride transfer specificity. *Arch. Biochem. Biophys.* 388, 378–382 (1997).

Zhou, X., Cahoon, M., Rosa, P., and Hedstrom, L. Expression, purification and characterization of inosine 5'-monophosphate dehydrogenase from *Borrelia burgdorferi*. *J. Biol. Chem.* 272, 21977–21981 (1997).

SEQUENCE LISTING

<160> NUMBER OF SEQ ID NOS: 23

<210> SEQ ID NO 1

<211> LENGTH: 15

<212> TYPE: PRT

<213> ORGANISM: *Streptococcus pyogenes*

<400> SEQUENCE: 1

Pro Gly Ser Ile Cys Thr Thr Arg Val Val Ala Gly Val Gly Val
1 5 10 15

<210> SEQ ID NO 2

<211> LENGTH: 15

-continued

<212> TYPE: PRT
 <213> ORGANISM: Bacillus subtilis

<400> SEQUENCE: 2

Pro Gly Ser Ile Cys Thr Thr Arg Val Val Ala Gly Val Gly Val
 1 5 10 15

<210> SEQ ID NO 3
 <211> LENGTH: 15
 <212> TYPE: PRT
 <213> ORGANISM: Escherichia coli

<400> SEQUENCE: 3

Pro Gly Ser Ile Cys Thr Thr Arg Ile Val Thr Gly Val Gly Val
 1 5 10 15

<210> SEQ ID NO 4
 <211> LENGTH: 15
 <212> TYPE: PRT
 <213> ORGANISM: Bacillus subtilis

<400> SEQUENCE: 4

Pro Gly Ser Ile Cys Thr Thr Arg Val Val Ala Gly Val Gly Val
 1 5 10 15

<210> SEQ ID NO 5
 <211> LENGTH: 15
 <212> TYPE: PRT
 <213> ORGANISM: Mycobacterium tuberculosis

<400> SEQUENCE: 5

Pro Gly Ser Ile Cys Thr Thr Arg Val Val Ala Gly Val Gly Val
 1 5 10 15

<210> SEQ ID NO 6
 <211> LENGTH: 15
 <212> TYPE: PRT
 <213> ORGANISM: Homo sapiens

<400> SEQUENCE: 6

Ser Gly Ser Ile Cys Ile Thr Gln Glu Val Leu Ala Cys Gly Arg
 1 5 10 15

<210> SEQ ID NO 7
 <211> LENGTH: 15
 <212> TYPE: PRT
 <213> ORGANISM: Mus musculus

<400> SEQUENCE: 7

Ser Gly Ser Ile Cys Ile Thr Gln Glu Val Leu Ala Cys Gly Arg
 1 5 10 15

<210> SEQ ID NO 8
 <211> LENGTH: 15
 <212> TYPE: PRT
 <213> ORGANISM: Arabidopsis thaliana

<400> SEQUENCE: 8

Ser Gly Ser Ile Cys Ile Thr Gln Glu Val Leu Ala Cys Gly Arg
 1 5 10 15

<210> SEQ ID NO 9
 <211> LENGTH: 15
 <212> TYPE: PRT
 <213> ORGANISM: Leishmania donovani

-continued

<400> SEQUENCE: 9

Ser Gly Ser Ile Cys Ile Thr Gln Glu Val Leu Ala Cys Gly Arg
 1 5 10 15

<210> SEQ ID NO 10

<211> LENGTH: 15

<212> TYPE: PRT

<213> ORGANISM: *Saccharomyces cerevisiae*

<400> SEQUENCE: 10

Thr Gly Ser Ile Cys Ile Thr Gln Lys Val Met Ala Cys Gly Arg
 1 5 10 15

<210> SEQ ID NO 11

<211> LENGTH: 15

<212> TYPE: PRT

<213> ORGANISM: *Drosophila melanogaster*

<400> SEQUENCE: 11

Ser Gly Ser Ile Cys Ile Thr Gln Glu Val Met Ala Cys Gly Arg
 1 5 10 15

<210> SEQ ID NO 12

<211> LENGTH: 23

<212> TYPE: PRT

<213> ORGANISM: *Streptococcus pyogenes*

<400> SEQUENCE: 12

Met Ala Lys Gly Ser Ser Asp Arg Tyr Phe Gln Ser Asp Asn Ala Ala
 1 5 10 15

Asp Lys Leu Val Pro Glu Gly
 20

<210> SEQ ID NO 13

<211> LENGTH: 23

<212> TYPE: PRT

<213> ORGANISM: *Bacillus subtilis*

<400> SEQUENCE: 13

Met Ser Lys Gly Ser Ser Asp Arg Tyr Phe Gln Ser Asp Asn Ala Ala
 1 5 10 15

Asp Lys Leu Val Pro Glu Gly
 20

<210> SEQ ID NO 14

<211> LENGTH: 24

<212> TYPE: PRT

<213> ORGANISM: *Escherichia coli*

<400> SEQUENCE: 14

Met Lys Lys Gly Ser Ser Asp Arg Tyr Phe Gln Gly Ser Val Asn Glu
 1 5 10 15

Ala Asn Lys Leu Val Pro Glu Gly
 20

<210> SEQ ID NO 15

<211> LENGTH: 21

<212> TYPE: PRT

<213> ORGANISM: *Bacillus subtilis*

<400> SEQUENCE: 15

Met Glu Lys Gly Ser Lys Asp Arg Tyr Phe Gln Glu Glu Asn Lys Lys

-continued

1 5 10 15

Phe Val Pro Glu Gly
 20

<210> SEQ ID NO 16
<211> LENGTH: 30
<212> TYPE: PRT
<213> ORGANISM: Mycobacterium tuberculosis

<400> SEQUENCE: 16

Met Arg Gly Arg Gly Ala Thr Ser Tyr Ser Lys Asp Arg Tyr Phe
1 5 10 15

Ala Asp Asp Ala Leu Ser Glu Asp Lys Leu Val Pro Glu Gly
 20 25 30

<210> SEQ ID NO 17
<211> LENGTH: 23
<212> TYPE: PRT
<213> ORGANISM: Homo sapiens

<400> SEQUENCE: 17

Met Asp Lys His Leu Ser Ser Gln Asn Arg Tyr Phe Ser Glu Ala Asp
1 5 10 15

Lys Ile Lys Val Ala Gln Gly
 20

<210> SEQ ID NO 18
<211> LENGTH: 23
<212> TYPE: PRT
<213> ORGANISM: Mus musculus

<400> SEQUENCE: 18

Met Asp Lys His Leu Ser Ser Gln Asn Arg Tyr Phe Ser Glu Ala Asp
1 5 10 15

Lys Ile Lys Val Ala Gln Gly
 20

<210> SEQ ID NO 19
<211> LENGTH: 27
<212> TYPE: PRT
<213> ORGANISM: Arabidopsis thaliana

<400> SEQUENCE: 19

Met Glu Arg Gly Asp Ala Lys Gly Ala Ala Met Ser Arg Tyr Tyr His
1 5 10 15

Asn Glu Met Asp Lys Met Lys Val Ala Gln Gly
 20 25

<210> SEQ ID NO 20
<211> LENGTH: 27
<212> TYPE: PRT
<213> ORGANISM: Leishmania donovani

<400> SEQUENCE: 20

Met Gln Lys Thr Gly Thr Lys Gly Asn Ala Ser Thr Ser Arg Tyr Phe
1 5 10 15

Ser Glu Ser Asp Ser Val Leu Val Ala Gln Gly
 20 25

<210> SEQ ID NO 21
<211> LENGTH: 21
<212> TYPE: PRT

-continued

<213> ORGANISM: Drosophila melanogaster

<400> SEQUENCE: 21

Met Thr Lys Gly Ser Asp Gln Arg Tyr Leu Gly Asp Gln Thr Lys Leu
 1 5 10 15
 Lys Ile Ala Gln Gly
 20

<210> SEQ ID NO 22

<211> LENGTH: 23

<212> TYPE: PRT

<213> ORGANISM: Saccharomyces cerevisiae

<400> SEQUENCE: 22

Met Ser Gln Gly Lys Glu Ser Gly Lys Arg Tyr Leu Ser Glu Asn Glu
 1 5 10 15
 Ala Val Gln Val Ala Gln Gly
 20

<210> SEQ ID NO 23

<211> LENGTH: 477

<212> TYPE: PRT

<213> ORGANISM: Artificial Sequence

<220> FEATURE:

<223> OTHER INFORMATION: Description of Artificial Sequence: Synthetic polypeptide

<221> NAME/KEY: MOD_RES

<222> LOCATION: (1)..(477)

<223> OTHER INFORMATION: "Xaa" represents selenomethionine

<400> SEQUENCE: 23

Ser Asn Trp Asp Thr Lys Phe Leu Lys Lys Gly Tyr Thr Phe Asp Asp
 1 5 10 15
 Val Leu Leu Ile Pro Ala Glu Ser His Val Leu Pro Asn Glu Val Asp
 20 25 30
 Leu Lys Thr Lys Leu Ala Asp Asn Leu Thr Leu Asn Ile Pro Ile Ile
 35 40 45
 Thr Ala Ala Xaa Asp Thr Val Thr Gly Ser Lys Xaa Ala Ile Ala Ile
 50 55 60
 Ala Arg Ala Gly Gly Leu Gly Val Ile His Lys Asn Xaa Ser Ile Thr
 65 70 75 80
 Glu Gln Ala Glu Glu Val Arg Lys Val Lys Arg Ser Glu Asn Gly Val
 85 90 95
 Ile Ile Asp Pro Phe Phe Leu Thr Pro Glu His Lys Val Ser Glu Ala
 100 105 110
 Glu Glu Leu Xaa Gln Arg Tyr Arg Ile Ser Gly Val Pro Ile Val Glu
 115 120 125
 Thr Leu Ala Asn Arg Lys Leu Val Gly Ile Ile Thr Asn Arg Asp Xaa
 130 135 140
 Arg Phe Ile Ser Asp Tyr Asn Ala Pro Ile Ser Glu His Xaa Thr Ser
 145 150 155 160
 Glu His Leu Val Thr Ala Ala Val Gly Thr Asp Leu Glu Thr Ala Glu
 165 170 175
 Arg Ile Leu His Glu His Arg Ile Glu Lys Leu Pro Leu Val Asp Asn
 180 185 190
 Ser Gly Arg Leu Ser Gly Leu Ile Thr Ile Lys Asp Ile Glu Lys Val
 195 200 205
 Ile Glu Phe Pro His Ala Ala Lys Asp Glu Phe Gly Arg Leu Leu Val
 210 215 220

-continued

Ala Ala Ala Val Gly Val Thr Ser Asp Thr Phe Glu Arg Ala Glu Ala
 225 230 235 240

Leu Phe Glu Ala Gly Ala Asp Ala Ile Val Ile Asp Thr Ala His Gly
 245 250 255

His Ser Ala Gly Val Leu Arg Lys Ile Ala Glu Ile Arg Ala His Phe
 260 265 270

Pro Asn Arg Thr Leu Ile Ala Gly Asn Ile Ala Thr Ala Glu Gly Ala
 275 280 285

Arg Ala Leu Tyr Asp Ala Gly Val Asp Val Val Lys Val Gly Ile Gly
 290 295 300

Pro Gly Ser Ile Cys Thr Thr Arg Val Val Ala Gly Val Gly Val Pro
 305 310 315 320

Gln Val Thr Ala Ile Tyr Asp Ala Ala Ala Val Ala Arg Glu Tyr Gly
 325 330 335

Lys Thr Ile Ile Ala Asp Gly Gly Ile Lys Tyr Ser Gly Asp Ile Val
 340 345 350

Lys Ala Leu Ala Ala Gly Gly Asn Ala Val Xaa Leu Gly Ser Xaa Phe
 355 360 365

Ala Gly Thr Asp Glu Ala Pro Gly Glu Thr Glu Ile Tyr Gln Gly Arg
 370 375 380

Lys Tyr Lys Thr Tyr Arg Gly Xaa Gly Ser Ile Ala Ala Xaa Lys Lys
 385 390 395 400

Asn Lys Leu Val Pro Glu Gly Ile Glu Gly Arg Val Ala Tyr Lys Gly
 405 410 415

Ala Ala Ser Asp Ile Val Phe Gln Xaa Leu Gly Gly Ile Arg Ser Gly
 420 425 430

Xaa Gly Tyr Val Gly Ala Gly Asp Ile Gln Glu Leu His Glu Asn Ala
 435 440 445

Gln Phe Val Glu Xaa Ser Gly Ala Gly Leu Ile Glu Ser His Pro His
 450 455 460

Asp Val Gln Ile Thr Asn Glu Ala Pro Asn Tyr Ser Val
 465 470 475

We claim:

1. A crystal of bacterial IMPDH (inosine monophosphate dehydrogenase) produced from purified and enzymatically active IMPDH obtained from a bacterial preparation wherein the bacterial preparation is a pure culture of *Streptococcus pyogenes*.

2. The crystal of claim 1 further characterized by an ability to provide x-ray diffraction patterns useful to define molecular structures for functional bacterial IMPDH enzymes.

3. A crystalline molecule or molecular complex derived from IMPDH with enzymatic activity, the molecule or molecular complex comprising a binding pocket, wherein said binding pocket is defined by structure coordinates of IMPDH amino acids 50-56, 75-80, 229-235, 252-260, 283-286, 302-322, 343-345, 365-432 and 449-455, in the Protein Data Bank Accession Number 1ZFJ.

4. A crystalline molecule or molecular complex produced from bacterial IMPDH of claim 3, wherein the binding

45 pocket has an amino acid sequence identity of 60% or greater relative to the *S. pyogenes* IMPDH binding pocket.

5. A method for developing lead compounds for an inhibitor of bacterial IMPDH (inosine monophosphate dehydrogenase), said method comprising:

- (a) obtaining a crystal of bacterial IMPDH;
- (b) recording x-ray diffraction data from said crystal;
- (c) using said diffraction data to generate an electron density map consistent with a model for the molecular structure of a binding pocket of bacterial IMPDH; and
- (d) developing lead compounds for an inhibitor of the bacterial IMPDH based on the map of three dimensional structural information of the molecular structure of the binding pocket of bacterial IMPDH.

* * * * *

UNITED STATES PATENT AND TRADEMARK OFFICE
CERTIFICATE OF CORRECTION

PATENT NO. : 6,826,488 B1
DATED : November 30, 2004
INVENTOR(S) : Frank R. Collart et al.

Page 1 of 1

It is certified that error appears in the above-identified patent and that said Letters Patent is hereby corrected as shown below:

Title page,

Item [75], Inventors, change "**Andrezej Joachimiak**" to -- **Andrezej Joachimiak** --.

Signed and Sealed this

Twelfth Day of April, 2005

A handwritten signature in black ink on a light gray dotted background. The signature reads "Jon W. Dudas" in a cursive style.

JON W. DUDAS

Director of the United States Patent and Trademark Office